



Inspur

CN12700 Series

System Management Config Guide

(Release 8.x)



Inspur-Cisco Networking Technology Co.,Ltd. provides customers with comprehensive technical support and services. For any assistance, please contact our local office or company headquarters.

Website: <http://www.inspur.com/>

Technical Support Tel: 400-691-1766

Technical Support Email: icnt_service@inspur.com

Technical Document Support Email: icnt_service@inspur.com

Address: 1036 Langchao Road, Lixia District, Jinan City, Shandong Province

Postal code: 250101

Notice

Copyright © 2020

Inspur Group.

All rights reserved.

No part of this publication may be excerpted, reproduced, translated or utilized in any form or by any means, electronic or mechanical, including photocopying and microfilm, without permission in Writing from **Inspur-Cisco Networking Technology Co.,Ltd.**



is the trademark of **Inspur-Cisco Networking Technology Co.,Ltd.**

All other trademarks and trade names mentioned in this document are the property of their respective holders. The information in this document is subject to change without notice. Every effort has been made in the preparation of this document to ensure accuracy of the contents, but all statements, information, and recommendations in this document do not constitute the warranty of any kind, express or implied

Preface

Objectives

This guide describes main functions of the CN12700 Series. To have a quick grasp of the CN12700 Series, please read this manual carefully.

Versions





The following table lists the product versions related to this document.

Product name	Version
CN12700 Series	

Conventions

Symbol conventions

The symbols that may be found in this document are defined as follows.

Symbol	Description
 Warning	Indicates a hazard with a medium or low level of risk which, if not avoided, could result in minor or moderate injury.
 Caution	Indicates a potentially hazardous situation that, if not avoided, could cause equipment damage, data loss, and performance degradation, or unexpected results.
 Note	Provides additional information to emphasize or supplement important points of the main text.
 Tip	Indicates a tip that may help you solve a problem or save time.

General conventions

Convention	Description
Boldface	Names of files, directories, folders, and users are in boldface . For example, log in as user root .
Italic	Book titles are in <i>italics</i> .
Lucida Console	Terminal display is in <code>Lucida Console</code> .

Command conventions

Convention	Description
Boldface	The keywords of a command line are in boldface .
Italic	Command arguments are in <i>italics</i> .
[]	Items (keywords or arguments) in square brackets [] are optional.
{ x y ... }	Alternative items are grouped in braces and separated by vertical bars. One is selected.
[x y ...]	Optional alternative items are grouped in square brackets and separated by vertical bars. One or none is selected.
{ x y ... } *	Alternative items are grouped in braces and separated by vertical bars. A minimum of one or a maximum of all can be selected.
[x y ...] *	The parameter before the & sign can be repeated 1 to n times.

GUI conventions

Convention	Description
Boldface	Buttons, menus, parameters, tabs, windows, and dialog titles are in boldface . For example, click OK .
>	Multi-level menus are in boldface and separated by the ">" signs. For example, choose File > Create > Folder .

Keyboard operation

Format	Description
Key	Press the key. For example, press Enter and press Tab .

Format	Description
Key 1+Key 2	Press the keys concurrently. For example, pressing Ctrl+C means the two keys should be pressed concurrently.
Key 1, Key 2	Press the keys in turn. For example, pressing Alt, A means the two keys should be pressed in turn.

Mouse operation

Action	Description
Click	Select and release the primary mouse button without moving the pointer.
Double-click	Press the primary mouse button twice continuously and quickly without moving the pointer.
Drag	Press and hold the primary mouse button and move the pointer to a certain position.

Change history

Updates between document versions are cumulative. Therefore, the latest document version contains all updates made to previous versions.

Issue 01 (2020-02-24)

Initial commercial release

Contents

Contents	i
Figure	xi
Table	xii
CHAPTER 1 Overview	1
1.1 Inspur INOS Device Configuration Methods.....	1
1.2 Inspur Fabric Services.....	3
1.3 Network Time Protocol.....	3
1.4 Precision Time Protocol.....	3
1.5 Inspur Discovery Protocol.....	3
1.6 System Messages.....	3
1.7 Smart Call Home.....	3
1.8 Rollback.....	3
1.9 Session Manager.....	4
1.10 Scheduler.....	4
1.11 SNMP.....	4
1.12 RMON.....	4
1.13 Online Diagnostics.....	4
1.14 Embedded Event Manager.....	4
1.15 Onboard Failure Logging.....	4
1.16 SPAN.....	5
1.17 ERSPAN.....	5
1.18 LLDP.....	5
1.19 NetFlow.....	5
1.20 FabricPath.....	5
1.21 EEE.....	5
1.22 Troubleshooting Features.....	5
CHAPTER 2 Configuring CFS	7
2.1 Finding Feature Information.....	7
2.2 About CFS.....	7
2.3 Licensing Requirements for CFS.....	9

2.4 Prerequisites for CFS.....	9
2.5 Guidelines and Limitations for CFS.....	10
2.6 Default Settings for CFS.....	10
2.7 Configuring CFS Distribution.....	10
2.8 Verifying the CFS Configuration.....	24
2.9 Additional References for CFS.....	24
2.10 Feature History for CFS.....	25
CHAPTER 3 Configuring NTP.....	26
3.1 Finding Feature Information.....	26
3.2 About NTP.....	26
3.3 Licensing Requirements for NTP.....	28
3.4 Prerequisites for NTP.....	28
3.5 Guidelines and Limitations for NTP.....	28
3.6 Default Settings for NTP.....	29
3.7 Configuring NTP.....	29
3.8 Verifying the NTP Configuration.....	40
3.9 Configuration Examples for NTP.....	40
3.10 Additional References.....	42
3.11 Feature History for NTP.....	42
CHAPTER 4 Configuring PTP.....	44
4.1 Finding Feature Information.....	44
4.2 About PTP.....	44
4.3 Virtualization Support.....	46
4.4 Licensing Requirements for PTP.....	46
4.5 Prerequisites for PTP.....	46
4.6 Guidelines and Limitations for PTP.....	46
4.7 Default Settings for PTP.....	47
4.8 Configuring PTP.....	47
4.9 Verifying the PTP Configuration.....	50
4.10 Configuration Examples for PTP.....	51
4.11 Related Documents.....	52
4.12 Feature History for PTP.....	52

CHAPTER 5 Configuring CDP.....	53
5.1 Finding Feature Information.....	53
5.2 About CDP.....	53
5.3 Licensing Requirements for CDP.....	54
5.4 Prerequisites for CDP.....	54
5.5 Guidelines and Limitations for CDP.....	54
5.6 Default Settings for CDP.....	55
5.7 Configuring CDP.....	55
5.8 Verifying the CDP Configuration.....	57
5.9 Configuration Example for CDP.....	57
5.10 Feature History for CDP.....	57
5.11 Finding Feature Information.....	59
5.12 About System Message Logging.....	59
5.13 Licensing Requirements for System Message Logging.....	60
5.14 Guidelines and Limitations for System Message Logging.....	60
5.15 Default Settings for System Message Logging.....	60
5.16 Configuring System Message Logging.....	61
5.17 Verifying the System Message Logging Configuration.....	67
5.18 Configuration Example for System Message Logging.....	67
5.19 Additional References.....	68
5.20 Feature History for System Message Logging.....	68
CHAPTER 6 Configuring Smart Call Home.....	69
6.1 Finding Feature Information.....	69
6.2 About Smart Call Home.....	69
6.3 Licensing Requirements for Smart Call Home.....	73
6.4 Prerequisites for Smart Call Home.....	73
6.5 Guidelines and Limitations for Smart Call Home.....	74
6.6 Default Settings for Smart Call Home.....	74
6.7 Configuring Smart Call Home.....	74
6.8 Verifying the Smart Call Home Configuration.....	85
6.9 Configuration Examples for Smart Call Home.....	86
6.10 Additional References.....	87

6.11 Feature History for Smart Call Home.....	98
CHAPTER 7 Configuring Rollback.....	99
7.1 Finding Feature Information.....	99
7.2 About Rollbacks.....	99
7.3 Licensing Requirements for Rollbacks.....	100
7.4 Prerequisites for Rollbacks.....	100
7.5 Guidelines and Limitations for Rollbacks.....	101
7.6 Default Settings for Rollbacks.....	102
7.7 Configuring Rollbacks.....	102
7.8 Verifying the Rollback Configuration.....	103
7.9 Configuration Example for Rollback.....	103
7.10 Feature History for Rollback.....	104
CHAPTER 8 Configuring Session Manager.....	105
8.1 Finding Feature Information.....	105
8.2 About Session Manager.....	105
8.3 Licensing Requirements for Session Manager.....	106
8.4 Prerequisites for Session Manager.....	106
8.5 Guidelines and Limitations for Session Manager.....	106
8.6 Configuring Session Manager.....	106
8.7 Verifying the Session Manager Configuration.....	108
8.8 Configuration Example for Session Manager.....	108
8.9 Feature History for Session Manager.....	109
CHAPTER 9 Configuring the Scheduler.....	110
9.1 Finding Feature Information.....	110
9.2 About the Scheduler.....	110
9.3 Licensing Requirements for the Scheduler.....	111
9.4 Prerequisites for the Scheduler.....	111
9.5 Guidelines and Limitations for the Scheduler.....	111
9.6 Default Settings for the Scheduler.....	112
9.7 Configuring the Scheduler.....	112
9.8 Verifying the Scheduler Configuration.....	115
9.9 Configuration Examples for the Scheduler.....	115

9.10 Feature History for the Scheduler.....	116
CHAPTER 10 Configuring SNMP.....	117
10.1 Finding Feature Information.....	117
10.2 About SNMP.....	117
10.3 Licensing Requirements for SNMP.....	122
10.4 Prerequisites for SNMP.....	122
10.5 Guidelines and Limitations for SNMP.....	122
10.6 Default Settings for SNMP.....	122
10.7 Configuring SNMP.....	122
10.8 Verifying SNMP Configuration.....	138
10.9 Configuration Examples for SNMP.....	139
10.10 Feature History for SNMP.....	140
CHAPTER 11 Configuring RMON.....	142
11.1 Finding Feature Information.....	142
11.2 About RMON.....	142
11.3 Licensing Requirements for RMON.....	143
11.4 Prerequisites for RMON.....	143
11.5 Guidelines and Limitations for RMON.....	143
11.6 Default Settings for RMON.....	144
11.7 Configuring RMON.....	144
11.8 Verifying the RMON Configuration.....	145
11.9 Configuration Examples for RMON.....	145
11.10 Feature History for RMON.....	146
CHAPTER 12 Configuring Online Diagnostics.....	147
12.1 Finding Feature Information.....	147
12.2 Information About Online Diagnostics.....	147
12.3 Licensing Requirements for Online Diagnostics.....	149
12.4 Guidelines and Limitations for Online Diagnostics.....	149
12.5 Default Settings for Online Diagnostics.....	150
12.6 Configuring Online Diagnostics.....	150
12.7 Verifying the Online Diagnostics Configuration.....	153
12.8 Configuration Examples for Online Diagnostics.....	154

12.9 Additional References.....	154
12.10 Feature History Table for Online Diagnostics.....	154
CHAPTER 13 Configuring the Embedded Event Manager.....	156
13.1 Finding Feature Information.....	156
13.2 About EEM.....	156
13.3 Prerequisites for EEM.....	159
13.4 Guidelines and Limitations for EEM.....	159
13.5 Default Settings for EEM.....	160
13.6 Configuring EEM.....	160
13.7 Verifying the EEM Configuration.....	175
13.8 Configuration Examples for EEM.....	176
13.9 Related Documents.....	177
13.10 Feature History for EEM.....	177
CHAPTER 14 Configuring Onboard Failure Logging.....	178
14.1 Finding Feature Information.....	178
14.2 About OBFL.....	178
14.3 Virtualization Support.....	179
14.4 Licensing Requirements for OBFL.....	179
14.5 Prerequisites for OBFL.....	179
14.6 Guidelines and Limitations for OBFL.....	179
14.7 Default Settings for OBFL.....	179
14.8 Configuring OBFL.....	179
14.9 Verifying the OBFL Configuration.....	181
14.10 Configuration Example for OBFL.....	182
14.11 Additional References.....	182
14.12 Feature History for OBFL.....	183
CHAPTER 15 Configuring SPAN.....	184
15.1 Finding Feature Information.....	184
15.2 About SPAN.....	184
15.3 Licensing Requirements for SPAN.....	188
15.4 Prerequisites for SPAN.....	188
15.5 Guidelines and Limitations for SPAN.....	188

15.6 Default Settings for SPAN.....	192
15.7 Configuring SPAN.....	192
15.8 Verifying the SPAN Configuration.....	213
15.9 Configuration Examples for SPAN.....	213
15.10 Related Documents.....	217
15.11 Feature History for SPAN.....	217
CHAPTER 16 Configuring ERSPAN.....	219
16.1 Finding Feature Information.....	219
16.2 About ERSPAN.....	219
16.3 Licensing Requirements for ERSPAN.....	222
16.4 Prerequisites for ERSPAN.....	223
16.5 Guidelines and Limitations for ERSPAN.....	223
16.6 Default Settings.....	224
16.7 Configuring ERSPAN.....	224
16.8 Verifying the ERSPAN Configuration.....	237
16.9 Configuration Examples for ERSPAN.....	238
16.10 Related Documents.....	241
16.11 Feature History for ERSPAN.....	241
CHAPTER 17 Configuring LLDP.....	242
17.1 Finding Feature Information.....	242
17.2 About LLDP.....	242
17.3 Licensing Requirements for LLDP.....	243
17.4 Guidelines and Limitations for LLDP.....	243
17.5 Default Settings for LLDP.....	244
17.6 Configuring LLDP.....	244
17.7 Verifying the LLDP Configuration.....	246
17.8 Configuration Example for LLDP.....	246
17.9 Related Documents.....	247
17.10 Feature History for LLDP.....	247
CHAPTER 18 Configuring NetFlow.....	248
18.1 Finding Feature Information.....	248
18.2 NetFlow.....	248

18.3 Licensing Requirements for NetFlow.....	251
18.4 Prerequisites for NetFlow.....	251
18.5 Guidelines and Limitations for NetFlow.....	251
18.6 Default Settings for NetFlow.....	253
18.7 Configuring NetFlow.....	253
18.8 Verifying the NetFlow Configuration.....	262
18.9 Monitoring NetFlow.....	262
18.10 Configuration Examples for NetFlow.....	262
18.11 Verification Examples for NetFlow CoPP Interface Support.....	263
18.12 Related Documents.....	264
18.13 Feature History for NetFlow.....	264
CHAPTER 19 Configuring EEE.....	266
19.1 Finding Feature Information.....	266
19.2 Information About EEE.....	266
19.3 Virtualization Support.....	266
19.4 Licensing Requirements for EEE.....	267
19.5 Prerequisites for EEE.....	267
19.6 Guidelines and Limitations.....	267
19.7 Default Settings.....	267
19.8 Configuring EEE.....	267
19.9 Verifying the EEE Configuration.....	268
19.10 Configuration Examples for EEE.....	269
19.11 Related Documents.....	269
19.12 Feature History for EEE.....	269
CHAPTER 20 Configuring GIR (Inspur INOS Release 7.3(0)D1(1) and later releases).....	270
20.1 Information About GIR.....	270
20.2 Guidelines and Limitations for GIR.....	274
20.3 Configuring Custom Maintenance Mode and Custom Normal Mode Profile.....	275
20.4 Creating a Snapshot.....	276
20.5 Adding Show Commands to Snapshots.....	277
20.6 Dumping Snapshot Sections.....	279
20.7 Entering Maintenance Mode.....	279

20.8 Returning to Normal Mode.....	284
20.9 Deleting a Maintenance Profile.....	286
20.10 Configuration Examples for GIR.....	287
20.11 Verifying GIR.....	294
20.12 Feature History for GIR.....	296
CHAPTER 21 Configuring iCAM.....	297
21.1 Feature History for iCAM.....	297
21.2 Information About iCAM.....	297
21.3 Licensing Requirements for iCAM.....	301
21.4 Default Settings for iCAM.....	302
21.5 Enabling iCAM.....	302
21.6 Enabling iCAM Monitoring on Resources and Traffic.....	302
21.7 Configuring iCAM Monitoring.....	303
21.8 Configuring Scale Monitoring.....	304
21.9 Displaying Current, Historical, and Predictive Traffic Analytics of TCAM Entries.....	313
21.10 Displaying Current, Historical, and Predictive TCAM Resource Usage per Feature.....	317
21.11 Explanation of the Display Outputs.....	318
21.12 Example: iCAM CLI Outputs.....	319
21.13 Example: Obtaining JSON Outputs for iCAM Configurations.....	340
21.14 Additional References for iCAM.....	343
CHAPTER 22 Performing Software Maintenance Upgrades.....	344
22.1 Prerequisites for SMUs.....	344
22.2 Guidelines and Limitations for SMUs.....	344
22.3 Information About Performing a Software Maintenance Upgrades.....	345
22.4 Performing a Software Maintenance Upgrade for Inspur INOS.....	346
22.5 Where to Go Next.....	355
22.6 Additional References.....	355
22.7 Feature Information for Performing Software Maintenance Upgrades.....	355
CHAPTER 23 Converting CLI Commands to Network Configuration Format.....	356
23.1 Finding Feature Information.....	356
23.2 Information About XMLIN.....	356
23.3 Licensing Requirements for XMLIN.....	356

23.4 Installing and Using the XMLIN Tool.....	356
23.5 Converting Show Command Output to XML.....	357
23.6 Configuration Examples for XMLIN.....	357
23.7 Related Documents.....	359
23.8 Feature History for XMLIN.....	359
CHAPTER 24 IETF RFCs supported by Inspur INOS System Management.....	360
24.1 IETF RFCs Supported by Inspur INOS System Management.....	360
24.2 EEM System Policies.....	360
24.3 EEM Events.....	361
24.4 Configuration Examples for EEM Policies.....	362

Figure

<i>Figure 1 Inspur INOS Device Configuration Methods.....</i>	<i>2</i>
<i>Figure 2 EEM Policy Statements.....</i>	<i>157</i>
<i>Figure 3 EEM Overview.....</i>	<i>158</i>
<i>Figure 4 SPAN Configuration.....</i>	<i>185</i>
<i>Figure 5 Virtual SPAN Configuration.....</i>	<i>187</i>
<i>Figure 6 ERSPAN Configuration.....</i>	<i>220</i>
<i>Figure 7 Maintenance Profile Scenarios.....</i>	<i>272</i>
<i>Figure 8 Snapshot Repository.....</i>	<i>273</i>
<i>Figure 9 Historical Traffic Data.....</i>	<i>300</i>
<i>Figure 10 Historical Resource Utilization.....</i>	<i>300</i>
<i>Figure 11 Predicted Traffic Data.....</i>	<i>301</i>
<i>Figure 12 Predicted Resource Utilization.....</i>	<i>301</i>
<i>Figure 13 Chord Diagram.....</i>	<i>316</i>
<i>Figure 14 Anomaly Visualization.....</i>	<i>317</i>
<i>Figure 15 Donut Chart Representing TCAM Resource Usage per Feature.....</i>	<i>318</i>
<i>Figure 16 Chord Diagram Representing Uniform Traffic Flow.....</i>	<i>321</i>
<i>Figure 17 Process to Add, Activate, and Commit SMU Packages.....</i>	<i>345</i>

Table

<i>Table 1 Configuration Methods Book Links</i>	2
<i>Table 2 CFS-Supported Applications</i>	7
<i>Table 3 Default CFS Parameters</i>	10
<i>Table 4 Feature History for CFS</i>	25
<i>Table 5 Feature History for NTP</i>	42
<i>Table 6 Default PTP Parameters</i>	47
<i>Table 7 PTP Show Commands</i>	50
<i>Table 8 Feature History for PTP</i>	52
<i>Table 9 Feature History for CDP</i>	57
<i>Table 10 System Message Severity Levels</i>	59
<i>Table 11 Default System Message Logging Parameters</i>	60
<i>Table 12 Syslog fields in syslog.conf</i>	66
<i>Table 13 Feature History for System Message Logging</i>	68
<i>Table 14 Severity and Syslog Level Mapping</i>	72
<i>Table 15 Default Smart Call Home Parameters</i>	74
<i>Table 16 Feature History for Smart Call Home</i>	98
<i>Table 17 Feature History for Rollback</i>	104
<i>Table 18 Feature History for Session Manager</i>	109
<i>Table 19 Feature History for the Scheduler</i>	116
<i>Table 20 SNMP Security Models and Levels</i>	119
<i>Table 21 AAA Exclusive Behavior Scenarios</i>	121
<i>Table 22 Enabling SNMP Notifications</i>	130
<i>Table 23 Feature History for SNMP</i>	140
<i>Table 24 Feature History for RMON</i>	146
<i>Table 25 Generic Online Diagnostics Supported on M3 Series</i>	150
<i>Table 26 Feature History for EEM</i>	177
<i>Table 27 Feature History for OBFL</i>	183
<i>Table 28 Supported Filter Fields</i>	186
<i>Table 29 Related Documents</i>	217
<i>Table 30 Feature History for SPAN</i>	217

<i>Table 31 Default ERSPAN Parameters</i>	224
<i>Table 32 Feature History for LLDP</i>	247
<i>Table 33 NetFlow Licensing Requirements</i>	251
<i>Table 34 Default NetFlow Parameters</i>	253
<i>Table 35 Feature History for NetFlow</i>	264
<i>Table 36 Default EEE Parameters</i>	267
<i>Table 37 EEE on an Ethernet interface</i>	268
<i>Table 38 Feature History for EEE</i>	269
<i>Table 39 Feature History for iCAM</i>	297
<i>Table 40 Licensing Requirements for iCAM</i>	301
<i>Table 41 Default iCAM Settings</i>	302
<i>Table 42 Commands for Copying SMU Package Files to the Device</i>	348
<i>Table 43 XMLIN Licensing Requirements</i>	356
<i>Table 44 Feature History for XMLIN</i>	359

CHAPTER 1 Overview

This chapter describes the system management features that you can use to monitor and manage Inspur INOS devices.

This chapter contains the following sections:

- Inspur INOS Device Configuration Methods
- Inspur Fabric Services
- Network Time Protocol
- Precision Time Protocol
- Inspur Discovery Protocol
- System Messages
- Smart Call Home
- Rollback
- Session Manager
- Scheduler
- SNMP
- RMON
- Online Diagnostics
- Embedded Event Manager
- Onboard Failure Logging
- SPAN
- ERSPAN
- LLDP
- NetFlow
- FabricPath
- EEE
- Troubleshooting Features

1.1 Inspur INOS Device Configuration Methods

You can configure devices using direct network configuration methods or web services hosted on a Inspur Data Center Network Management (DCNM) server.

This figure shows the device configuration methods available to a network user.

Figure 1 Inspur INOS Device Configuration Methods

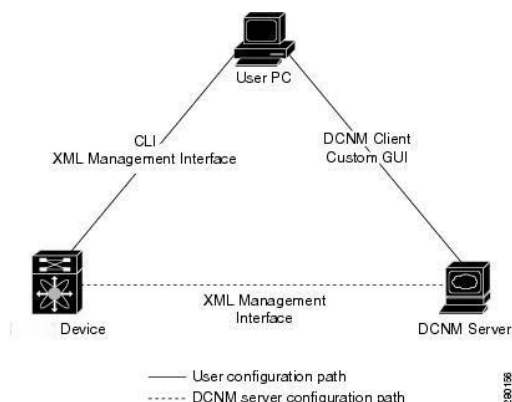

This table lists the configuration method and the document where you can find more information.

Table 1 Configuration Methods Book Links

Configuration Method	Document
CLI from a Secure Shell (SSH) session, a Telnet session, or the console port	<i>Inspur CN12700 Series INOS Fundamentals Configuration Guide</i>
XML management interface	<i>Inspur INOS XML Management Interface User Guide</i>
Inspur DCNM client	<i>Inspur DCNM Fundamentals Guide</i>
User-defined GUI	<i>Web Services API Guide, Inspur DCNM for LAN Release 5.x</i>

This section includes the following topics:

- Configuring with CLI or XML Management Interface
- Configuring with Inspur DCNM or a Custom GUI

1.1.1 Configuring with CLI or XML Management Interface

You can configure Inspur INOS devices using the command-line interface (CLI) or the XML management interface over Secure Shell (SSH) as follows:

- CLI from an SSH session, a Telnet session, or the console port—You can configure devices using the CLI from an SSH session, a Telnet session, or the console port. SSH provides a secure connection to the device.
- XML management interface over SSH—You can configure devices using the XML management interface, which is a programmatic method based on the NETCONF protocol that complements the CLI functionality. For more information, see the Inspur INOS XML Management Interface User Guide.

1.1.2 Configuring with Inspur DCNM or a Custom GUI

You can configure Inspur INOS devices using the Inspur DCNM client or from your own GUI as follows:

- Inspur DCNM Client—You can configure devices using the Inspur DCNM client, which runs on your local PC and uses web services on the Inspur DCNM server. The Inspur DCNM server configures the device over the XML management interface. For more information about the Inspur DCNM client, see the Fundamentals Configuration Guide, Inspur DCNM for LAN, Release 5.x .

- Custom GUI—You can create your own GUI to configure devices using the Inspur DCNM web services application program interface (API) on the Inspur DCNM server. You use the SOAP protocol to exchange XML-based configuration messages with the Inspur DCNM server. The Inspur DCNM server configures the device over the XML management interface. For more information about creating custom GUIs, see the Web Services API Guide, Inspur DCNM for LAN, Release 5.x

1.2 Inspur Fabric Services

Inspur Fabric Services (CFS) is a Inspur proprietary feature that distributes data, including configuration changes, to all Inspur INOS devices in a network.

1.3 Network Time Protocol

The Network Time Protocol (NTP) synchronizes the time of day among a set of distributed time servers and clients so that you can correlate time-specific information, such as system logs, received from the devices in your network.

1.4 Precision Time Protocol

The Precision Time Protocol (PTP) is a time synchronization protocol for nodes distributed across a network. Its hardware timestamp feature provides greater accuracy than other time synchronization protocols such as Network Time Protocol (NTP). For more information about PTP.

1.5 Inspur Discovery Protocol

You can use the Inspur Discovery Protocol (CDP) to discover and view information about all Inspur equipment that is directly attached to your device. CDP runs on all Inspur-manufactured equipment including routers, bridges, access and communication servers, and switches. CDP is media and protocol independent, and gathers the protocol addresses of neighboring devices, discovering the platform of those devices. CDP runs over the data link layer only. Two systems that support different Layer 3 protocols can learn about each other.

1.6 System Messages

You can use system message logging to control the destination and to filter the severity level of messages that system processes generate. You can configure logging to a terminal session, a log file, and syslog servers on remote systems.

System message logging is based on RFC 3164. For more information about the system message format and the messages that the device generates, see the Inspur INOS System Messages Reference.

1.7 Smart Call Home

Call Home provides an e-mail-based notification of critical system policies. Inspur INOS provides a range of message formats for optimal compatibility with pager services, standard e-mail, or XML-based automated parsing applications. You can use this feature to page a network support engineer, e-mail a Network Operations Center, or use Inspur Smart Call Home services to automatically generate a case with the Technical Assistance Center.

1.8 Rollback

The rollback feature allows you to take a snapshot, or checkpoint, of the device configuration and then reapply that configuration at any point without having to reload. Rollback allows any authorized administrator to apply this checkpoint configuration without requiring expert knowledge of the features configured in the checkpoint.

Session Manager allows you to create a configuration session and apply all commands within that session atomically.

1.9 Session Manager

Session Manager allows you to create a configuration and apply it in batch mode after the configuration is reviewed and verified for accuracy and completeness.

1.10 Scheduler

The scheduler allows you to create and manage jobs such as routinely backing up data or making quality of service (QoS) policy changes. The scheduler can start a job according to your needs—only once at a specified time or at periodic intervals.

1.11 SNMP

The Simple Network Management Protocol (SNMP) is an application-layer protocol that provides a message format for communication between SNMP managers and agents. SNMP provides a standardized framework and a common language used for the monitoring and management of devices in a network.

1.12 RMON

Remote monitoring (RMON) is an Internet Engineering Task Force (IETF) standard monitoring specification that allows various network agents and console systems to exchange network monitoring data. Inspur INOS supports RMON alarms, events, and logs to monitor Inspur INOS devices.

1.13 Online Diagnostics

Inspur Generic Online Diagnostics (GOLD) define a common framework for diagnostic operations across Inspur platforms. The online diagnostic framework specifies the platform-independent fault-detection architecture for centralized and distributed systems, including the common diagnostics CLI and the platform-independent fault-detection procedures for boot-up and run-time diagnostics. The platform-specific diagnostics provide hardware-specific fault-detection tests and allow you to take appropriate corrective action in response to diagnostic test results.

1.14 Embedded Event Manager

The Embedded Event Manager (EEM) allows you to detect and handle critical events in the system. EEM provides event detection and recovery, including monitoring of events either as they occur or as thresholds are crossed.

1.15 Onboard Failure Logging

You can configure a device to log failure data to persistent storage, which you can retrieve and display for analysis at a later time. This on-board failure logging (OBFL) feature stores failure and environmental information in nonvolatile memory on the module. This information is useful for analysis of failed modules.

1.16 SPAN

You can configure an Ethernet Switched Port Analyzer (SPAN) to monitor traffic in and out of your device. The SPAN features allow you to duplicate packets from source ports to destination ports.

1.17 ERSPAN

Encapsulated remote switched port analyzer (ERSPAN) is used to transport mirrored traffic in an IP network. ERSPAN supports source ports, source VLANs, and destinations on different switches, which provide remote monitoring of multiple switches across your network. ERSPAN uses a generic routing encapsulation (GRE) tunnel to carry traffic between switches.

ERSPAN consists of an ERSPAN source session, routable ERSPAN GRE-encapsulated traffic, and an ERSPAN destination session. You separately configure ERSPAN source sessions and destination sessions on different switches.

To configure an ERSPAN source session on one switch, you associate a set of source ports or VLANs with a destination IP address, ERSPAN ID number, and virtual routing and forwarding (VRF) name. To configure an ERSPAN destination session on another switch, you associate the destinations with the source IP address, the ERSPAN ID number, and a VRF name. The ERSPAN source session copies traffic from the source ports or source VLANs and forwards the traffic using routable GRE-encapsulated packets to the ERSPAN destination session. The ERSPAN destination session switches the traffic to the destinations.

1.18 LLDP

Link Layer Discovery Protocol (LLDP) is a vendor-neutral, one-way device discovery protocol that allows network devices to advertise information about themselves to other devices on the network. This protocol runs over the data-link layer, which allows two systems running different network layer protocols to learn about each other. You can enable LLDP globally or per interface.

1.19 NetFlow

NetFlow identifies packet flows for both ingress and egress IP packets and provide statistics based on these packet flows. NetFlow does not require any change to either the packets themselves or to any networking device.

1.20 FabricPath

FabricPath brings the benefits of Layer 3 routing to Layer 2 switched networks to build a highly resilient and scalable Layer 2 fabric. The system manager is responsible for starting the FabricPath resources process and monitoring heartbeats.

1.21 EEE

Energy Efficient Ethernet (EEE) is an IEEE 802.3az standard that is designed to reduce power consumption in Ethernet networks during idle periods. EEE can be enabled on devices that support low power idle (LPI) mode. Such devices can save power by entering LPI mode during periods of low utilization. In LPI mode, systems on both ends of the link can save power by shutting down certain services. EEE provides the protocol needed to transition into and out of LPI mode in a way that is transparent to upper layer protocols and applications.

1.22 Troubleshooting Features

Inspur INOS provides troubleshooting tools such as ping, traceroute, Ethanalyzer, and the Blue Beacon feature.

When a service fails, the system generates information that can be used to determine the cause of the failure. The following sources of information are available:

- Every service restart generates a syslog message of level LOG_ERR.
- If the Smart Call Home service is enabled, every service restart generates a Smart Call Home event.
- If SNMP traps are enabled, the SNMP agent sends a trap when a service is restarted.
- When a service failure occurs on a local module, you can view a log of the event by entering the show processes log command in that module. The process logs are persistent across supervisor switchovers and resets.
- When a service fails, a system core image file is generated. You can view recent core images by entering the show cores command on the active supervisor. Core files are not persistent across supervisor switchovers and resets, but you can configure the system to export core files to an external server using the file transfer utility Trivial File Transfer Protocol (TFTP) by entering the system cores command.
- INSPUR-SYSTEM-MIB contains a table for cores (cseSwCoresTable).

CHAPTER 2 Configuring CFS

This chapter describes how to use Inspur Fabric Services (CFS), a Inspur proprietary feature that distributes data, including configuration changes, to all Inspur INOS devices in a network.

This chapter includes the following sections:

- Finding Feature Information
- About CFS
- Licensing Requirements for CFS
- Prerequisites for CFS
- Guidelines and Limitations for CFS
- Default Settings for CFS
- Configuring CFS Distribution
- Verifying the CFS Configuration
- Additional References for CFS
- Feature History for CFS

2.1 Finding Feature Information

Your software release might not support all the features documented in this module. For the latest caveats and feature information, the release notes for your software release. To find information about the features documented in this module, and to see a list of the releases in which each feature is supported, see the "New and Changed Information" chapter or the Feature History table in this chapter.

2.2 About CFS

You can use Inspur Fabric Services (CFS) to distribute and synchronize a configuration on one Inspur device with all other Inspur devices in your network. CFS provides you with consistent and, in most cases, identical configurations and behavior in your network.

2.2.1 Applications that Use CFS to Distribute Configuration Changes

CFS distributes configuration changes for the applications listed in the following table.

Table 2 CFS-Supported Applications

Application	Default State
Device alias	Enabled
DPVM	Enabled
FC domain	Disabled
FC port security	Disabled
FC timer	Disabled
IVR	Disabled
NTP	Disabled
RADIUS	Disabled
RSCN	Disabled
Smart Call Home	Disabled
TACACS+	Disabled
User roles	Disabled

2.2.2 CFS Distribution

CFS distributes configuration changes to multiple devices across a complete network. CFS supports the following types of distribution:

- CFS over Ethernet (CFS over Ethernet)—Distributes application data over an Ethernet network.
- CFS over IP (CFS over IP)—Distributes application data over an IPv4 network.
- CFS over Fibre Channel (CFS over Fibre Channel)—Distributes application data over a Fibre Channel, such as a virtual storage area network (VSAN). If the device is provisioned with Fibre Channel ports, CFS over Fibre Channel is enabled by default.

Beginning with Inspur INOS Release 5.2, you can configure Fibre Channel over Ethernet (FCoE), which allows Fibre Channel traffic to be encapsulated over a physical Ethernet link. To run FCoE on a Inspur CN12700 Series switch, you must configure a dedicated storage virtual device context (VDC). If FCoE is enabled on the device, CFS over Fibre Channel services can be used. The applications that require CFS distribution to be enabled in the storage VDC are noted in the configuration instructions throughout this chapter. For more information on FCoE and storage VDCs, see the Inspur INOS FCoE Configuration Guide for Inspur CN12700 and Inspur MDS 9500 and the Inspur CN12700 Series INOS Virtual Device Context Configuration Guide.

2.2.2.1 CFS Distribution Modes

CFS supports three distribution modes to accommodate different feature requirements. Only one mode is allowed at a given time.

- Uncoordinated distributions—Distribute information that is not expected to conflict with that from a peer. Parallel uncoordinated distributions are allowed for an application.
- Coordinated distributions—Distribute information that can be manipulated and distributed from multiple devices (for example, the port security configuration). Coordinated distributions allow only one application distribution at a given time. CFS uses locks to enforce this. A coordinated distribution is not allowed to start if locks are acquired for the application anywhere in the network. A coordinated distribution consists of three stages:
 - A network lock is acquired.
 - The configuration is distributed and committed.
 - The network lock is released.

CFS can execute these stages in response to an application request without intervention from the application or under complete control of the application.

- Unrestricted uncoordinated distributions—Allow multiple parallel distributions in the network in the presence of an existing coordinated distribution. Unrestricted uncoordinated distributions are allowed to run in parallel with all other types of distributions.

2.2.3 CFS Connectivity in a Mixed Fabric

CFS is an infrastructure component that also runs on the Inspur CN12700 Series switches. A mixed fabric of different platforms can interact with each other.

Using CFS over IP, the respective CFS clients can also talk to their instances running on the other platforms. Within a defined domain and distribution scope, CFS can distribute the client's data and configuration to its peers running on other platforms.

All three platforms support both CFS over IP and CFS over Fibre Channel. However, the Inspur CN12700 Series switches require an FC or FCoE plugin and corresponding configuration in order for CFS over Fibre Channel to operate.

2.2.4 CFS Merge Support

An application keeps the configuration synchronized in the fabric through CFS. When two such fabrics become reachable to one another, CFS triggers a merge. These two fabrics could have two different sets of configuration information that need to be reconciled in the event of a merge. CFS provides notification each time an application peer comes online. If a fabric with M application peers merges with another fabric with N application peers and if an application triggers a merge action on every notification, a link-up event results in MxN merges in the fabric.

CFS supports a protocol that reduces the number of merges required to one by handling the complexity of the merge at the CFS layer. This protocol runs per application per scope. The protocol involves selecting one device in a fabric as the merge manager for that fabric. The other devices do not have a role in the merge process.

During a merger of two networks, their designated managers exchange configuration databases. The application on one of them merges the databases, decides if the merge is successful, and notifies all other devices.

In the merge is successful, the merged database is distributed to all devices in the combined fabric, and the entire new fabric remains in a consistent state.

2.2.5 Locking the Network

When you configure an application that uses the CFS infrastructure, that application starts a CFS session and locks the network. When a network is locked, the device software allows configuration changes to this application only from the device holding the lock. If you make configuration changes to the application from another device, the device issues a message to inform the user about the locked status. The configuration changes are held in a pending database by that application.

If you start a CFS session that requires a network lock but forget to end the session, an administrator can clear the session. If you lock a network at any time, your username is remembered across restarts and switchovers. If another user (on the same machine) tries to perform configuration tasks, that user's attempts are rejected.

2.2.6 CFS Regions

A CFS region is a user-defined subset of devices for a given feature or application. You usually define regions to localize or restrict distribution based on devices that are close to one another. When a network covers many geographies with many different administrators who are responsible for subsets of devices, you can manage the scope of an application by setting up a CFS region.

CFS regions are identified by numbers ranging from 0 through 200. Region 0 is reserved as the default region and contains every device in the network. You can configure regions from 1 through 200.

You can configure a CFS region to distribute configurations for multiple applications. However, on a given device, you can configure only one CFS region at a time to distribute the configuration for a given application. Once you assign an application to a CFS region, its configuration cannot be distributed within another CFS region.

2.2.7 High Availability

Stateless restarts are supported for CFS. After a reboot or a supervisor switchover, the running configuration is applied.

2.3 Licensing Requirements for CFS

Product	License Requirement
Inspur INOS	CFS requires no license. Any feature not included in a license package is bundled with the Inspur INOS system images and is provided at no extra charge to you. For a complete explanation of the Inspur INOS licensing scheme, see the <i>Inspur INOS Licensing Guide</i> .

2.4 Prerequisites for CFS

CFS has the following prerequisites:

- CFS is enabled by default. All devices in the fabric must have CFS enabled, or they do not receive distributions.
- If CFS is disabled for an application, that application does not distribute any configuration, and it does not accept a distribution from other devices in the fabric.

2.5 Guidelines and Limitations for CFS

CFS has the following configuration guidelines and limitations:

- If the virtual port channel (vPC) feature is enabled for your device, do not disable CFSvE.
- All CFSvIP-enabled devices with similar multicast addresses form one CFSvIP fabric.
- Make sure that CFS is enabled for the applications that you want to configure.
- Anytime you lock a fabric, your username is remembered across restarts and switchovers.
- Anytime you lock a fabric, configuration changes attempted by anyone else are rejected.
- While a fabric is locked, the application holds a working copy of configuration changes in a pending database or temporary storage area, not in the running configuration.
 - Configuration changes that have not been committed yet (still saved as a working copy) are not in the running configuration and do not display in the output of show commands.
 - If you start a CFS session that requires a fabric lock but forget to end the session, an administrator can clear the session.
 - An empty commit is allowed if configuration changes are not previously made. In this case, the commit command results in a session that acquires locks and distributes the current database.
 - You can use the commit command only on the specific device where the fabric lock was acquired.
 - CFSvIP and CFSvE are not supported for use together.
 - CFS regions can be applied only to CFSvIP applications.
 - You cannot distribute the user role configuration the storage VDC configured for a Inspur CN12700 Series switch. To prevent this distribution, make sure to assign the user role configuration in Inspur MDS and the Inspur CN12700 storage VDC to different CFS regions.
 - CFS uses the same MAC address 01:80:c2:00:00:0e as the standard IEEE protocol Link Layer Discovery Protocol (LLDP), and sniffer software such as Ethalyzer or Wireshark decodes CFS traffic as LLDP traffic.

2.6 Default Settings for CFS

Table 3 Default CFS Parameters

Parameters	Default
CFS distribution on the device	Enabled
CFSvIP	Disabled
IPv4 multicast address	239.255.70.83
CFSvFC	Enabled, if FCoE is present
CFSvE	Disabled

2.7 Configuring CFS Distribution

2.7.1 Enabling CFS Distribution for Applications

2.7.1.1 Enabling CFS to Distribute Smart Call Home Configurations

You can enable CFS to distribute Call Home configurations to all Inspur INOS devices in the network. The entire Call Home configuration is distributed except the device priority and the sysContact names.

Procedure

	Command or Action	Purpose
Step 1	switch# configure terminal	Enters global configuration mode.
Step 2	switch(config)# callhome	Enters Call Home configuration mode.
Step 3	switch(config-callhome)# distribute	Enables CFS to distribute Smart Call Home configuration updates.
Step 4	(Optional) switch(config-callhome)# show application-name status	For the specified application, displays the CFS distribution status.
Step 5	(Optional) switch(config-callhome)# copy running-config startup-config	Saves the change persistently through reboots and restarts by copying the running configuration to the startup configuration.

Example

```
switch# configure terminal
switch(config)# callhome
switch(config-callhome)# distribute
switch(config-callhome)# show callhome status
Distribution : Enabled
switch(config-callhome)# copy running-config startup-config
```

2.7.1.2 Enabling CFS to Distribute Device Alias Configurations

You can enable CFS to distribute device alias configurations in order to consistently administer and maintain the device alias database across all Inspur INOS devices in the fabric.

Before you begin

Make sure that you are in the storage VDC. To change to the storage VDC, use the `switchto vdc fcoe` command.

Procedure

	Command or Action	Purpose
Step 1	switch# configure terminal	Enters global configuration mode.
Step 2	switch(config)# device-alias distribute	Enables CFS to distribute device alias configuration updates.
Step 3	(Optional) switch(config)# show cfs application	Displays the CFS distribution status.
Step 4	(Optional) switch(config)# copy running-config startup config	Saves the change persistently through reboots and restarts by copying the running configuration to the startup configuration.

Example

This example shows how to enable CFS to distribute device alias configurations:

```
switch(config)# device-alias distribute
switch(config)# show cfs application
-----
Application Enabled Scope
-----
```

```
device-alias Yes Physical-fc
switch(config)# copy running-config startup-config
[#####] 100%
```

2.7.1.3 Enabling CFS to Distribute DPVM Configurations

You can enable CFS to distribute dynamic port VSAN membership (DPVM) configurations in order to consistently administer and maintain the DPVM database across all Inspur INOS devices in the fabric.

Before you begin

Make sure that you are in the storage VDC. To change to the storage VDC, use the `switchto vdc fcoe` command. Make sure that you enable the DPVM feature. To do so, use the `feature dpvm` command.

Procedure

	Command or Action	Purpose
Step 1	switch# configure terminal	Enters global configuration mode.
Step 2	switch(config)# dpvm distribute	Enables CFS to distribute DPVM configuration updates.
Step 3	(Optional) switch(config)# show application-name status	For the specified application, displays the CFS distribution status.
Step 4	(Optional) switch(config)# copy running-config startup config	Saves the change persistently through reboots and restarts by copying the running configuration to the startup configuration.

Example

This example shows how to enable CFS to distribute DPVM configurations:

```
switch(config)# dpvm distribute
switch(config)# show dpvm status
Distribution is enabled.
switch(config)# copy running-config startup-config
[#####] 100%
```

2.7.1.4 Enabling CFS to Distribute FC Domain Configurations

You can enable CFS to distribute Fibre Channel (FC) domain configurations in order to synchronize the configuration across the fabric from the console of a single Inspur INOS device and to ensure consistency in the allowed domain ID lists on all devices in the VSAN.

Before you begin

Make sure that you are in the storage VDC. To change to the storage VDC, use the `switchto vdc fcoe` command.

Procedure

	Command or Action	Purpose
Step 1	switch# configure terminal	Enters global configuration mode.
Step 2	switch(config)# fcdomain distribute	Enables CFS to distribute FC domain configuration updates.
Step 3	(Optional) switch(config)# show application-name status	For the specified application, displays the CFS distribution status.

	Command or Action	Purpose
Step 4	(Optional) switch(config)# copy running-config startup config	Saves the change persistently through reboots and restarts by copying the running configuration to the startup configuration.

Example

This example shows how to enable CFS to distribute FC domain configurations:

```
switch(config)# fcdomain distribute
switch(config)# show fcdomain status
fcdomain distribution is enabled
switch(config)# copy running-config startup-config
[#####] 100%
```

2.7.1.5 Enabling CFS to Distribute FC Port Security Configurations

You can enable CFS to distribute Fibre Channel (FC) port security configurations in order to provide a single point of configuration for the entire fabric in the VSAN and to enforce the port security policies throughout the fabric.

Before you begin

Make sure that you are in the storage VDC. To change to the storage VDC, use the `switchto vdc fcoe` command. Make sure that you enable the FC port security feature. To do so, use the `feature fc-port-security` command.

Procedure

	Command or Action	Purpose
Step 1	switch# configure terminal	Enters global configuration mode.
Step 2	switch(config)# fc-port-security distribute	Enables CFS to distribute FC port security configuration updates.
Step 3	(Optional) switch(config)# show cfs application	Displays the CFS distribution status.
Step 4	(Optional) switch(config)# copy running-config startup config	Saves the change persistently through reboots and restarts by copying the running configuration to the startup configuration.

Example

This example shows how to enable CFS to distribute FC port security configurations:

```
switch(config)# fc-port-security distribute
switch(config)# show cfs application
-----
Application Enabled Scope
-----
fc-port-securi Yes Logical
switch(config)# copy running-config startup-config
[#####] 100%
```

2.7.1.6 Enabling CFS to Distribute FC Timer Configurations

You can enable CFS to distribute Fibre Channel (FC) timer configurations for all Inspur INOS devices in the fabric.

Before you begin

Make sure that you are in the storage VDC. To change to the storage VDC, use the `switchto vdc fcoe` command.

Procedure

	Command or Action	Purpose
Step 1	switch# configure terminal	Enters global configuration mode.
Step 2	switch(config)# fctimer distribute	Enables CFS to distribute FC timer configuration updates.
Step 3	(Optional) switch(config)# show application-name status	For the specified application, displays the CFS distribution status.
Step 4	(Optional) switch(config)# copy running-config startup config	Saves the change persistently through reboots and restarts by copying the running configuration to the startup configuration.

Example

This example shows how to enable CFS to distribute FC timer configurations:

```
switch(config)# fctimer distribute
switch(config)# show fctimer status
Distribution : Enabled
switch(config)# copy running-config startup-config
[#####] 100%
```

2.7.1.7 Enabling CFS to Distribute IVR Configurations

You can enable CFS to distribute inter-VSAN routing (IVR) configurations in order to enable efficient IVR configuration management and to provide a single point of configuration for the entire fabric in the VSAN.

Before you begin

Make sure that you are in the storage VDC. To change to the storage VDC, use the `switchto vdc fcoe` command.

Make sure that you install the Advanced SAN Services license.

Make sure that you enable the IVR feature. To do so, use the `feature ivr` command.

Procedure

	Command or Action	Purpose
Step 1	switch# configure terminal	Enters global configuration mode.
Step 2	switch(config)# ivr distribute	Enables CFS to distribute IVR configuration updates. Note You must enable IVR distribution on all IVR-enabled switches in the fabric.
Step 3	(Optional) switch(config)# show cfs application	Displays the CFS distribution status.
Step 4	(Optional) switch(config)# copy running-config startup config	Saves the change persistently through reboots and restarts by copying the running configuration to the startup configuration.

Example

This example shows how to enable CFS to distribute IVR configurations:

```
switch(config)# ivr distribute
switch(config)# show cfs application
-----
Application Enabled Scope
```



```

-----
ivr Yes Physical-fc
switch(config)# copy running-config startup-config
[#####] 100%

```

2.7.1.8 Enabling CFS to Distribute NTP Configurations

You can enable CFS to distribute NTP configurations to all Inspur INOS devices in the network.

Before you begin

Make sure that you enable the NTP feature (using the `feature ntp` command).

Procedure

	Command or Action	Purpose
Step 1	switch# configure terminal	Enters global configuration mode.
Step 2	switch(config)# ntp distribute	Enables CFS to distribute NTP configuration updates.
Step 3	(Optional) switch(config)# show application-name status	For the specified application, displays the CFS distribution status.
Step 4	(Optional) switch(config)# copy running-config startup config	Saves the change persistently through reboots and restarts by copying the running configuration to the startup configuration.

Example

```

switch# configure terminal
switch(config)# ntp distribute
switch(config)# show ntp status
Distribution : Enabled
switch(config)# copy running-config startup-config

```

2.7.1.9 Enabling CFS to Distribute RADIUS Configurations

You can enable CFS to distribute RADIUS configurations to all Inspur INOS devices in the network.

Procedure

	Command or Action	Purpose
Step 1	switch# configure terminal	Enters global configuration mode.
Step 2	switch(config)# radius distribute	Enables CFS to distribute RADIUS configuration updates.
Step 3	(Optional) switch(config)# show application-name status	For the specified application, displays the CFS distribution status.
Step 4	(Optional) switch(config)# copy running-config startup config	Saves the change persistently through reboots and restarts by copying the running configuration to the startup configuration.

Example

```

switch# configure terminal
switch(config)# radius distribute switch(config)# show radius status
Distribution : Enabled
switch(config)# copy running-config startup-config

```

2.7.1.10 Enabling CFS to Distribute RSCN Configurations

You can enable CFS to distribute registered state change notification (RSCN) configurations to all Inspur INOS devices in the fabric.

Before you begin Procedure

Make sure that you are in the storage VDC. To change to the storage VDC, use the `switchto vdc fcoe` command.

	Command or Action	Purpose
Step 1	<code>switch# configure terminal</code>	Enters global configuration mode.
Step 2	<code>switch(config)# rscn distribute</code>	Enables CFS to distribute RSCN configuration updates.
Step 3	(Optional) <code>switch(config)# show cfs application</code>	Displays the CFS distribution status.
Step 4	(Optional) <code>switch(config)# copy running-config startup config</code>	Saves the change persistently through reboots and restarts by copying the running configuration to the startup configuration.

Example

This example shows how to enable CFS to distribute RSCN configurations:

```
switch(config)# rscn distribute
switch(config)# show cfs application
-----
Application Enabled Scope
-----
rscn Yes Logical
switch(config)# copy running-config startup-config
[#####] 100%
```

2.7.1.11 Enabling CFS to Distribute TACACS+ Configurations

You can enable CFS to distribute TACACS+ configurations to all Inspur INOS devices in the network.

Before you begin

Make sure that you enable the TACACS+ feature (using the `feature tacacs+` command).

Procedure

	Command or Action	Purpose
Step 1	<code>switch# configure terminal</code>	Enters global configuration mode.
Step 2	<code>switch(config)# tacacs+ distribute</code>	Enables CFS to distribute TACACS+ configuration updates.
Step 3	(Optional) <code>switch(config)# show application-name status</code>	For the specified application, displays the CFS distribution status.
Step 4	(Optional) <code>switch(config)# copy running-config startup config</code>	Saves the change persistently through reboots and restarts by copying the running configuration to the startup configuration.

Example

```
switch# configure terminal
switch(config)# tacacs+ distribute
switch(config)# show tacacs+ status
```

```
Distribution : Enabled
switch(config)# copy running-config startup-config
```

2.7.1.12 Enabling CFS to Distribute User Role Configurations

You can enable CFS to distribute user role configurations to all Inspur INOS devices in the network.

Procedure

	Command or Action	Purpose
Step 1	switch# configure terminal	Enters global configuration mode.
Step 2	switch(config)# role distribute	Enables CFS to distribute user role configurations.
Step 3	(Optional) switch(config)# show application-name status	For the specified application, displays the CFS distribution status.
Step 4	(Optional) switch(config)# copy running-config startup config	Saves the change persistently through reboots and restarts by copying the running configuration to the startup configuration.

Example

```
switch# configure terminal
switch(config)# role distribute
switch(config)# show role status
Distribution : Enabled
switch(config)# copy running-config startup-config
```

2.7.2 Specifying a CFS Distribution Mode

You can specify and enable an Ethernet or IPv4 CFS distribution mode.

Procedure

	Command or Action	Purpose
Step 1	switch# configure terminal	Enters global configuration mode.
Step 2	switch(config)# cfs {eth ipv4} distribute	Globally enables CFS distribution over Ethernet or IPv4 for all applications on the device.
Step 3	(Optional) switch(config)# show cfs status	Shows the current state of CFS, including the distribution mode.
Step 4	(Optional) switch(config)# copy running-config startup config	Saves the change persistently through reboots and restarts by copying the running configuration to the startup configuration.

Example

```
switch# configure terminal
switch(config)# cfs ipv4 distribute
switch(config)# show cfs status
Distribution : Enabled Distribution
over IP : Disabled
Distribution over Ethernet : Enabled
switch(config)# copy running-config startup-config
```

2.7.3 Configuring an IP Multicast Address for CFSolP

For CFS protocol-specific distributions, such as the keepalive mechanism for detecting network topology changes, use the IP multicast address to send and receive information. You can configure the IP multicast address used to distribute CFSIPv4.

Procedure

	Command or Action	Purpose
Step 1	switch# configure terminal	Enters global configuration mode.
Step 2	switch(config)# no cfs ipv4 distribute	Globally disables CFSIPv4 distribution for all applications on the device. Note You must disable CFSIPv4 before you can change the multicast address.
Step 3	switch(config)# cfs ipv4 mcast-address <i>ip-address</i>	Configures the multicast address for CFS distribution over IPv4. The ranges of valid IPv4 addresses are 239.255.0.0 through 239.255.255.255 and 239.192/16 through 239.251/16.
Step 4	switch(config)# cfs ipv4 distribute	Globally enables CFSIPv4 distribution for all applications on the device.
Step 5	(Optional) switch(config)# show cfs status	Shows the current state of CFS, including whether it is enabled, its IP mode, and its multicast addresses.
Step 6	(Optional) switch(config)# copy running-config startup-config	Saves the change persistently through reboots and restarts by copying the running configuration to the startup configuration.

Example

```
switch# configure terminal
switch(config)# no cfs ipv4 distribute
This will prevent CFS from distributing over IPv4 network.
Are you sure? (y/n) [n] y
switch(config)# cfs ipv4 mcast-address 239.255.1.1
Distribution over this IP type will be affected
Change multicast address for CFS-IP?
Are you sure? (y/n) [n] y
switch(config)# cfs ipv4 distribute
switch(config)# show cfs status
Distribution : Enabled
Distribution over IP : Enabled - mode IPv4
IPv4 multicast address : 239.255.1.1
switch(config)# copy running-config startup-config
```

2.7.4 Configuring CFS Regions

2.7.4.1 Creating a CFS Region

You can create a CFS region and add an application, such as Smart Call Home, to it.

Procedure

	Command or Action	Purpose
Step 1	switch# configure terminal	Enters global configuration mode.
Step 2	switch(config)# cfs region <i>region-number</i>	Creates the region and enters the configuration

	Command or Action	Purpose
		mode for the specified region.
Step 3	switch(config-cfs-region)# <i>application-name</i>	For the specified region, adds the named application.
Step 4	(Optional) switch(config-cfs-region)# show cfs regions brief	Shows all configured regions and applications but does not show peers.
Step 5	(Optional) switch(config-cfs-region)# copy running-config startup-config	Saves the change persistently through reboots and restarts by copying the running configuration to the startup configuration.

Example

```
switch# configure terminal
switch(config)# cfs region 4
switch(config-cfs-region)# callhome
switch(config-cfs-region)# show cfs regions brief
-----
Region Application Enabled
-----
4      callhome   yes
switch(config-cfs-region)# copy running-config startup-config
```

2.7.4.2 Moving an Application to a Different CFS Region

You can move an application to a different region. For example, you can move NTP from region 1 to region 2.

Procedure

	Command or Action	Purpose
Step 1	switch# configure terminal	Enters global configuration mode.
Step 2	switch(config)# cfs region region-number	Enters the configuration mode for the specified region.
Step 3	Required: switch(config-cfs-region)# <i>application-name</i>	Specifies the applications to be moved.
Step 4	(Optional) switch(config-cfs-region)# show cfs regions name application-name	Displays peers and region information for a given application.
Step 5	(Optional) switch(config-cfs-region)# copy running-config startup-config	Copies the running configuration to the startup configuration.

Example

```
switch# configure terminal
switch(config)# cfs region 2
switch(config-cfs-region)# callhome
switch(config-cfs-region)# show cfs regions name callhome
Region-ID : 2
Application: callhome
Scope : Physical-fc-ip
-----
Switch WWN IP Address
-----
20:00:00:22:55:79:a4:c1 172.28.230.85 [Local]
switch
Total number of entries = 1
switch(config-cfs-region)# copy running-config startup-config
```

2.7.4.3 Removing an Application from a CFS Region

You can remove an application from a region. Removing an application from a region is the same as moving the application back to the default region. The default region is usually region 0. This action brings the entire fabric into the scope of distribution for the application.

Procedure

	Command or Action	Purpose
Step 1	switch# configure terminal	Enters global configuration mode.
Step 2	switch(config)# cfs region <i>region-number</i>	Enters the configuration mode for the specified region.
Step 3	Required: switch(config-cfs-region)# no <i>application-name</i>	Removes the specified application from the region.
Step 4	(Optional) Repeat Step 3 for each application that you want to remove from this region.	
Step 5	(Optional) switch(config-cfs-region)# show cfs regions brief	Shows all configured regions and applications but does not show peers.
Step 6	(Optional) switch(config-cfs-region)# copy running-config startup-config	Copies the running configuration to the startup configuration.

Example

```
switch# configure terminal
switch(config)# cfs region 2
switch(config-cfs-region)# no ntp
switch(config-cfs-region)# show cfs regions brief
-----
Region Application Enabled
-----
4      tacacs+      yes
6      radius       yes
switch(config-cfs-region)# copy running-config startup-config
```

2.7.4.4 Deleting a CFS Region

You can delete a region and move all included applications back to the default region.

Procedure

	Command or Action	Purpose
Step 1	switch# configure terminal	Enters global configuration mode.
Step 2	switch(config)# no cfs region <i>region-number</i>	Deletes the specified region after warning that this action causes all applications in the region to move to the default region. Note After you delete the region, you are returned to the global configuration mode.
Step 3	(Optional) switch(config)# show cfs regions brief	Shows all configured regions and applications but does not show peers.
Step 4	(Optional) switch(config)# show cfs application name <i>application-name</i>	Shows local application information by name.
Step 5	(Optional) switch(config)# copy running-config	Saves the change persistently through reboots and

	Command or Action	Purpose
	startup config	restarts by copying the running configuration to the startup configuration.

Example

```
switch# configure terminal
switch(config)# no cfs region 4
WARNING: All applications in the region will be moved to default region.
Are you sure? (y/n) [n] y
switch(config)# show cfs regions brief
-----
Region Application Enabled
-----
6      callhome      no
switch(config)# show cfs application name callhome
Enabled : Yes
Timeout : 20s
Merge Capable : Yes
Scope : Physical-fc-ip
Region : Default
switch(config)# copy running-config startup-config
```

2.7.5 Creating and Distributing a CFS Configuration

You can create a configuration change for an application and then distribute it to its application peers.

Caution	If you do not commit the changes, they are not distributed and saved in the running configuration of application peer devices.
----------------	--

Caution	If you do not save the changes to the startup configuration in every application peer device where distributed, changes are retained only in their running configurations.
----------------	--

Procedure

	Command or Action	Purpose
Step 1	switch# configure terminal	Enters global configuration mode.
Step 2	Required: switch(config)# <i>application-name</i>	Specifies that CFS starts a session for the specified application name and locks the fabric.
Step 3	Required: switch(config-callhome)# <i>application-command</i>	Specifies that configuration changes are saved as a working copy and are not saved in the running configuration until you enter the commit command.
Step 4	(Optional) Repeat Step 3 for each configuration command that you want to add.	
Step 5	(Optional) switch(config-callhome)# show application-name status	For the specified application, displays the CFS distribution status.
Step 6	Required: switch(config-callhome)# commit	CFS distributes the configuration changes to the running configuration of every application peer device. If one or more external devices report a successful status, the software overwrites the running configuration with the changes from the CFS working copy and releases the fabric lock. If none of the external

	Command or Action	Purpose
		devices report a successful status, no changes are made, and the fabric lock remains in place.
Step 7	(Optional) switch(config-callhome)# copy running-config startup-config	Saves the change persistently through reboots and restarts by copying the running configuration to the startup configuration.

Example

```
switch# configure terminal
switch(config)# snmp-server contact personname@companyname.com
switch(config)# callhome
switch(config-callhome)# email-contact admin@Mycompany.com
switch(config-callhome)# phone-contact +1-800-123-4567
switch(config-callhome)# street-address 123 Anystreet st. Anytown,AnyWhere
switch(config-callhome)# show callhome status
Distribution : Enabled switch(config-callhome)# commit
switch(config-callhome)# copy running-config startup-config
```

2.7.6 Clearing a Locked Session

You can clear a lock held by an application from any device in the fabric.

Caution	When you clear a lock in the fabric, any pending configurations in any device in the fabric are discarded.
----------------	--

Before you begin

You must have administrator permissions to release a lock.

Procedure

	Command or Action	Purpose
Step 1	(Optional) switch# show application-name status	Shows the current application state.
Step 2	Required: switch# clear application-name session	Clears the application configuration session and releases the lock on the fabric. All pending changes are discarded.
Step 3	(Optional) switch# show application-name status	Shows the current application state.

Example

```
switch# show ntp status
Distribution : Enabled
Last operational state: Fabric Locked
switch# clear ntp session
switch# show ntp status
Distribution : Enabled
Last operational state: No session
```

2.7.7 Discarding a CFS Configuration

You can discard configuration changes and release the lock.

Caution	If you discard configuration changes, the application flushes the pending database and releases locks in the fabric.
----------------	--

Procedure

	Command or Action	Purpose
Step 1	switch# configure terminal	Enters global configuration mode.
Step 2	Required: switch(config)# <i>application-name</i> abort	Aborts the application configuration, discards the configuration changes, closes the CFS session, and releases the fabric lock. Note The abort command is supported only on the device where the fabric lock is acquired.
Step 3	(Optional) switch(config)# show application-name session status	For the specified application, displays the CFS session status.

Example

```
switch# configure terminal
switch(config)# ntp abort
This will prevent CFS from distributing the configuration to other switches.
Are you sure? (y/n) [n] y
switch(config)# show ntp session status
Last Action Time Stamp : Wed Aug 14 16:07:25 2013
Last Action : Abort
Last Action Result : Success
Last Action Failure Reason : none
```

2.7.8 Disabling CFS Distribution Globally

You can disable CFS distribution for a device, isolating the applications using CFS from fabric-wide distributions while maintaining physical connectivity. When CFS is globally disabled on a device, CFS operations are restricted to the device, and all CFS commands continue to function as if the device was physically isolated.

Before you begin

If the virtual port channel (vPC) feature is enabled, only IP distribution is disabled. You must first disable vPC before you can disable CFS distribution.

Procedure

	Command or Action	Purpose
Step 1	switch# configure terminal	Enters global configuration mode.
Step 2	switch(config)# no cfs distribute	Globally disables CFS distribution for all applications on the device.
Step 3	(Optional) switch(config)# show cfs status	Displays the global CFS distribution status for the device.
Step 4	(Optional) switch(config)# copy running-config startup config	Saves the change persistently through reboots and restarts by copying the running configuration to the startup configuration.

Example

```
switch# configure terminal
```

```

switch(config)# no cfs distribute
This will prevent CFS from distributing the configuration to other switches.
Are you sure? (y/n) [n] y
switch(config)# show cfs status
Distribution : Disabled
Distribution over IP : Disabled
IPv4 multicast address : 239.255.70.83 Distribution
over Ethernet : Disabled
switch(config)# copy running-config startup-config

```

2.8 Verifying the CFS Configuration

Command	Purpose
show application-name session status	Displays the configuration session status, including the last action, the result, and the reason if there was a failure.
show application-name status	For the specified application, displays the CFS distribution status.
show cfs application	Displays the applications that are currently CFS enabled.
show cfs application name application-name	Displays the details for a particular application, including the enabled or disabled state, timeout as registered with CFS, merge capability if registered with CFS for merge support, distribution scope, and distribution region.
show cfs internal	Displays information internal to CFS including memory statistics, event history, and so on.
show cfs lock	Displays all active locks.
show cfs merge status name name [detail]	Displays the merge status for a given application.
show cfs peers	Displays all the peers in the physical fabric.
show cfs regions	Displays all the applications with peers and region information.
show cfs status	Displays the status of CFS distribution on the device as well as IP distribution information.
show logging level cfs	Displays the CFS logging configuration.
show tech-support cfs	Displays information about the CFS configuration required by technical support when resolving a CFS issue.

2.9 Additional References for CFS

Related Documents

Related Topic	Document Title
CFS CLI commands	<i>Inspur CN12700 Series INOS System Management Command Reference</i> <i>Inspur CN12700 Series INOS SAN Switching Command Reference</i>
CFS configuration for device alias CFS configuration for DPVM CFS configuration for FC domain CFS configuration for FC port security CFS configuration for FC timer CFS configuration for IVR CFS configuration for RSCN	<i>Inspur CN12700 Series INOS SAN Switching Configuration Guide</i>
FCoE	<i>Inspur INOS FCoE Configuration Guide for Inspur CN12700</i>

Related Topic	Document Title
RADIUS	<i>Inspur CN12700 Series INOS Security Configuration Guide</i>
TACACS+	<i>Inspur CN12700 Series INOS Security Configuration Guide</i>
User roles	<i>Inspur CN12700 Series INOS Security Configuration Guide</i>

2.10 Feature History for CFS

The table below summarizes the new and changed features for this document and shows the releases in which each feature is supported. Your software release might not support all the features in this document. For the latest caveats and feature information, the release notes for your software release.

Table 4 Feature History for CFS

Feature Name	Release	Feature Information
CFS protocol	5.2(1)	Added CFS over Fibre Channel (CFS over FC) distribution support for device alias, DPVM, FC domain, FC port security, FC timer, IVR, and RSCN.
CFS protocol	4.1(2)	This feature was introduced.

CHAPTER 3 Configuring NTP

This chapter describes how to configure the Network Time Protocol (NTP) on Inspur INOS devices. This chapter includes the following sections:

- Finding Feature Information
- About NTP
- Licensing Requirements for NTP
- Prerequisites for NTP
- Guidelines and Limitations for NTP
- Default Settings for NTP
- Configuring NTP
- Verifying the NTP Configuration
- Configuration Examples for NTP
- Additional References
- Feature History for NTP

3.1 Finding Feature Information

Your software release might not support all the features documented in this module. For the latest caveats and feature information, the release notes for your software release. To find information about the features documented in this module, and to see a list of the releases in which each feature is supported, see the "New and Changed Information" chapter or the Feature History table in this chapter.

3.2 About NTP

The Network Time Protocol (NTP) synchronizes the time of day among a set of distributed time servers and clients so that you can correlate events when you receive system logs and other time-specific events from multiple network devices. NTP uses the User Datagram Protocol (UDP) as its transport protocol. All NTP communications use Coordinated Universal Time (UTC).

An NTP server usually receives its time from an authoritative time source, such as a radio clock or an atomic clock attached to a time server, and then distributes this time across the network. NTP is extremely efficient; no more than one packet per minute is necessary to synchronize two machines to within a millisecond of each other.

NTP uses a stratum to describe the distance between a network device and an authoritative time source:

- A stratum 1 time server is directly attached to an authoritative time source (such as a radio or atomic clock or a GPS time source).
- A stratum 2 NTP server receives its time through NTP from a stratum 1 time server.

Before synchronizing, NTP compares the time reported by several network devices and does not synchronize with one that is significantly different, even if it is a stratum 1. Because Inspur INOS cannot connect to a radio or atomic clock and act as a stratum 1 server, we recommend that you use the public NTP servers available on the Internet. If the network is isolated from the Internet, Inspur INOS allows you to configure the time as though it were synchronized through NTP, even though it was not.

The time kept on a device is a critical resource, so we strongly recommend that you use the security features of NTP to avoid the accidental or malicious setting of incorrect time. Two mechanisms are available: an access list-based restriction scheme and an encrypted authentication mechanism.

3.2.1 NTP Associations

An NTP association can be one of the following:

- A peer association—The device can either synchronize to another device or allow another device to synchronize to it.
- A server association—The device synchronizes to a server.

You need to configure only one end of an association. The other device can automatically establish the association.

3.2.1.1 NTP Broadcast Associations

In a broadcast-based NTP association, an NTP server sends NTP broadcast packets throughout a network. Broadcast clients listen for the NTP broadcast packets sent by the server and do not engage in any polling.

NTP broadcast servers allow you to synchronize a large number of clients without creating a lot of NTP traffic because unsolicited messages are sent to a designated IPv4 local broadcast address, and ordinarily no request is expected from the clients.

3.2.1.2 NTP Multicast Associations

When the device operates as an NTP multicast server, it sends NTP multicast messages to a designated IPv4 or IPv6 multicast group IP address.

When the device operates as an NTP multicast client, it listens for NTP multicast packets that are sent by an NTP multicast server to a designated IPv4 or IPv6 multicast group IP address.

NTP multicast servers allow you to synchronize a large number of clients without creating a lot of NTP traffic because unsolicited messages are sent to a designated multicast group address, and ordinarily no request is expected from the clients.

3.2.2 NTP as a Time Server

The Inspur INOS device can use NTP to distribute time. Other devices can configure it as a time server. You can also configure the device to act as an authoritative NTP server, enabling it to distribute time even when it is not synchronized to an outside time source.

3.2.3 Distributing NTP Using CFS

Inspur Fabric Services (CFS) distributes the local NTP configuration to all Inspur devices in the network.

After enabling CFS on your device, a network-wide lock is applied to NTP whenever an NTP configuration is started. After making the NTP configuration changes, you can discard or commit them.

In either case, the CFS lock is then released from the NTP application.

3.2.4 Clock Manager

Clocks are resources that need to be shared across different processes. Multiple time synchronization protocols, such as NTP, might be running in the system.

The clock manager allows you to specify the protocol to control the various clocks in the system. Once you specify the protocol, the system clock starts updating. For information on configuring the clock manager, see the *Inspur CN12700 Series INOS Fundamentals Configuration Guide*.

3.2.5 High Availability

Stateless restarts are supported for NTP. After a reboot or a supervisor switchover, the running configuration is applied. For more information on high availability, see the *Inspur CN12700 Series INOS High Availability and*

Redundancy Guide.

You can configure NTP peers to provide redundancy in case an NTP server fails.

3.2.6 Virtualization Support

If you are running a Inspur INOS Release prior to 5.2, up to one instance of NTP is supported on the entire platform. You must configure NTP in the default virtual device context (VDC), and you are automatically placed in the default VDC unless you specify otherwise.

If you are running Inspur INOS Release 5.2 or later, multiple instances of NTP are supported, one instance per VDC. By default, Inspur INOS places you in the default VDC unless you specifically configure another VDC. Only one VDC (the default VDC by default) synchronizes the system clock at any given time. The NTP daemon in all other VDCs acts only as an NTP server for the other devices. To change which VDC synchronizes the system clock, use the clock protocol `ntp vdc vdc-id` command.

NTP recognizes virtual routing and forwarding (VRF) instances. NTP uses the default VRF if you do not configure a specific VRF for the NTP server and NTP peer. See the *Inspur CN12700 Series INOS Unicast Routing Configuration Guide* for more information about VRFs.

3.3 Licensing Requirements for NTP

Product	License Requirement
Inspur INOS	NTP requires no license. Any feature not included in a license package is bundled with the INOS image and is provided at no extra charge to you. For a complete explanation of the Inspur INOS licensing scheme, see the <i>Inspur INOS Licensing Guide</i> .

3.4 Prerequisites for NTP

NTP has the following prerequisites:

- To configure NTP, you must have connectivity to at least one server that is running NTP.
- To configure VDCs, you must install the appropriate license. See the Inspur CN12700 Series INOS Virtual Device Context Configuration Guide for configuration information and the Inspur INOS Licensing Guide for licensing information.

3.5 Guidelines and Limitations for NTP

NTP has the following configuration guidelines and limitations:

- The Inspur INOS software supports NTP version 4 (NTPv4).
- NTP server functionality is supported.
- You should have a peer association with another device only when you are sure that your clock is reliable (which means that you are a client of a reliable NTP server).
 - A peer configured alone takes on the role of a server and should be used as a backup. If you have two servers, you can configure several devices to point to one server and the remaining devices to point to the other server. You can then configure a peer association between these two servers to create a more reliable NTP configuration.
 - If you have only one server, you should configure all the devices as clients to that server.
 - We recommend that you do not configure (just) two NTP servers. Instead, you should configure one, three, or four or more NTP servers.

All NTP servers return the time together with an estimate of the current error. When using multiple time servers, NTP also wants these servers to agree on some time, meaning there must be one error interval where the correct time must be. When there are just two NTP servers, there might be an issue if both sources do not fall into the small common range because the NTP client will be unable to determine which source is more correct.

- You can configure up to 64 NTP entities (servers and peers).
- If you configure NTP in a VRF, ensure that the NTP server and peers can reach each other through the configured VRFs.
 - You must manually distribute NTP authentication keys on the NTP server and Inspur INOS devices across the network.
 - If CFS is disabled for NTP, then NTP does not distribute any configuration and does not accept a distribution from other devices in the network.
 - After CFS distribution is enabled for NTP, the entry of an NTP configuration command locks the network for NTP configuration until a commit command is entered. During the lock, no changes can be made to the NTP configuration by any other device in the network except the device that initiated the lock.
 - If you use CFS to distribute NTP, all devices in the network should have the same VRFs configured as you use for NTP.
 - If you configure NTP in a VRF, ensure that the NTP server and peers can reach each other through the configured VRFs
 - You must manually distribute NTP authentication keys on the NTP server and Inspur INOS devices across the network.
 - Use NTP broadcast or multicast associations when time accuracy and reliability requirements are modest, your network is localized, and the network has more than 20 clients. We recommend that you use NTP broadcast or multicast associations in networks that have limited bandwidth, system memory, or CPU resources.
 - The NTP source-interface and source configuration has a limitation of getting applied only when configured on the client. If the configuration is done on the server (the switch with the NTP master), source address of the outgoing packet will still be that of the received destination address.

3.6 Default Settings for NTP

The following table lists the default settings for NTP parameters.

Parameters	Default
NTP	Enabled in all VDCs and for all interfaces. By default, NTP is enabled as server and client.
NTP passive (enabling NTP to form associations)	Enabled
NTP authentication	Disabled
NTP access	Enabled
NTP access group match all	Disabled
NTP broadcast server	Disabled
NTP multicast server	Disabled
NTP multicast client	Disabled
NTP logging	Disabled

3.7 Configuring NTP

3.7.1 Enabling or Disabling NTP in a VDC

You can enable or disable NTP in a particular VDC. NTP is enabled in all VDCs by default.

Procedure

	Command or Action	Purpose
Step 1	configure terminal Example: switch# configure terminal switch(config)#	Enters global configuration mode.
Step 2	[no] feature ntp Example: switch(config)# feature ntp	Enables or disables NTP.
Step 3	(Optional) show ntp status Example: switch(config)# show ntp status Distribution: Enabled Last operational state: Fabric Locked	Displays the status of the NTP application.
Step 4	(Optional) copy running-config startup-config Example: switch(config)# copy running-config startup-config	Copies the running configuration to the startup configuration.

3.7.2 Enabling or Disabling NTP on an Interface

You can enable or disable NTP in a particular interface. NTP is enabled in all VDCs by default.

Procedure

	Command or Action	Purpose
Step 1	configure terminal Example: switch# config t Enter configuration commands, one per line. End with CNTL/Z. switch(config)#	Enters global configuration mode.
Step 2	interface <i>slot/port</i> Example: switch(config)# interface ethernet 6/1 switch(config-if)#	Enters interface configuration mode.
Step 3	(Optional) [no]ntp disable {ip ipv6} Example: switch(config-if)# ntp disable ip	Disables NTP IPv4 or IPv6 on the specified interface. Use the no form of this command to reenables NTP on the interface.
Step 4	(Optional) copy running-config startup-config Example: switch(config)# copy running-config startup-config	Saves the change persistently through reboots and restarts by copying the running configuration to the startup configuration

3.7.3 Configuring the Device as an Authoritative NTP Server

You can configure the device to act as an authoritative NTP server, enabling it to distribute time even when it is not synchronized to an existing time server.

Procedure

	Command or Action	Purpose
Step 1	configure terminal Example: switch# configure terminal switch(config)#	Enters global configuration mode.
Step 2	[no] ntp master [<i>stratum</i>] Example: switch(config)# ntp master	Configures the device as an authoritative NTP server. You can specify a different stratum level from which NTP clients get their time synchronized. The range is from 1 to 15.
Step 3	(Optional) show running-config ntp Example: switch(config)# show running-config ntp	Displays the NTP configuration.
Step 4	(Optional) copy running-config startup-config Example: switch(config)# copy running-config startup-config	Copies the running configuration to the startup configuration.

3.7.4 Configuring an NTP Server and Peer

You can configure an NTP server and peer.

Before you begin

Make sure you know the IP address or Domain Name System (DNS) names of your NTP server and its peers.

Procedure

	Command or Action	Purpose
Step 1	configure terminal Example: switch# configure terminal switch(config)#	Enters global configuration mode.
Step 2	[no] ntp server { <i>ip-address</i> <i>ipv6-address</i> <i>dns-name</i> } [key <i>key-id</i>] [maxpoll <i>max-poll</i>] [minpoll <i>min-poll</i>] [prefer] [use-vrf <i>vrf-name</i>] Example: switch(config)# ntp server 192.0.2.10	Forms an association with a server. Use the key keyword to configure a key to be used while communicating with the NTP server. The range for the <i>key-id</i> argument is from 1 to 65535. Use the maxpoll and minpoll keywords to configure the maximum and minimum intervals in which to poll a server. The range for the <i>max-poll</i> and <i>min-poll</i> arguments is from 4 to 16 seconds, and the default values are 6 and 4, respectively. Use the prefer keyword to make this server the preferred NTP server for the device. Use the use-vrf keyword to configure the NTP server to communicate over the specified VRF. The <i>vrf-name</i> argument can be default , management , or any case-sensitive, alphanumeric string up to 32 characters. Note If you configure a key to be used while communicating with the NTP server, make sure that the key exists as a trusted key on the device.

	Command or Action	Purpose
Step 3	<p>[no] ntp peer {ip-address ipv6-address dns-name} [key key-id] [maxpoll max-poll] [minpoll min-poll] [prefer] [use-vrf vrf-name]</p> <p>Example: switch(config)# ntp peer 2001:0db8::4101</p>	<p>Forms an association with a peer. You can specify multiple peer associations.</p> <p>Use the key keyword to configure a key to be used while communicating with the NTP peer. The range for the <i>key-id</i> argument is from 1 to 65535.</p> <p>Use the maxpoll and minpoll keywords to configure the maximum and minimum intervals in which to poll a peer. The range for the <i>max-poll</i> and <i>min-poll</i> arguments is from 4 to 17 seconds, and the default values are 6 and 4, respectively.</p> <p>Use the prefer keyword to make this peer the preferred NTP peer for the device.</p> <p>Use the use-vrf keyword to configure the NTP peer to communicate over the specified VRF. The <i>vrf-name</i> argument can be default, management, or any case-sensitive, alphanumeric string up to 32 characters.</p>
Step 4	<p>(Optional) show ntp peers</p> <p>Example: switch(config)# show ntp peers</p>	<p>Displays the configured server and peers.</p> <p>Note A domain name is resolved only when you have a DNS server configured.</p>
Step 5	<p>(Optional) copy running-config startup-config</p> <p>Example: switch(config)# copy running-config startup-config</p>	<p>Copies the running configuration to the startup configuration.</p>

3.7.5 Configuring NTP Authentication

You can configure the device to authenticate the time sources to which the local clock is synchronized. When you enable NTP authentication, the device synchronizes to a time source only if the source carries one of the authentication keys specified by the ntp trusted-key command. The device drops any packets that fail the authentication check and prevents them from updating the local clock. NTP authentication is disabled by default.

Before you begin

Authentication for NTP servers and NTP peers is configured on a per-association basis using the key keyword on each ntp server and ntp peer command. Make sure that you configured all NTP server and peer associations with the authentication keys that you plan to specify. Any ntp server or ntp peer commands that do not specify the key keyword will continue to operate without authentication.

Procedure

	Command or Action	Purpose
Step 1	<p>configure terminal</p> <p>Example: switch# configure terminal switch(config)#</p>	<p>Enters global configuration mode.</p>
Step 2	<p>[no] ntp authentication-key number md5 md5-string</p> <p>Example:</p>	<p>Defines the authentication keys. The device does not synchronize to a time source unless the source has one of these authentication keys and</p>

	Command or Action	Purpose
	switch(config)# ntp authentication-key 42 md5 aNiceKey	the key number is specified by the ntp trusted-key number command. The range for authentication keys is from 1 to 65535. For the MD5 string, you can enter up to eight alphanumeric characters. Beginning with Inspur INOS Release 7.3(0)D1(1), you can enter up to 32 alphanumeric characters for the MD5 string.
Step 3	(Optional) show ntp authentication-keys Example: switch(config)# show ntp authentication-keys	Displays the configured NTP authentication keys.
Step 4	[no] ntp trusted-key number Example: switch# config t Enter configuration commands, one per line. End with CNTL/Z. switch(config)# ntp authentication-key 42 md5 aNiceKey switch(config)# ntp server 10.1.1.1 key 42 switch(config)# ntp trusted-key 42 switch(config)# ntp authenticate switch(config)# copy running-config startup-config [#####] 100% switch(config)#	Specifies one or more keys (defined in Step 2) that a time source must provide in its NTP packets in order for the device to synchronize to it. The range for trusted keys is from 1 to 65535. This command provides protection against accidentally synchronizing the device to a time source that is not trusted.
Step 5	(Optional) show ntp trusted-keys Example: switch(config)# show ntp trusted-keys	Displays the configured NTP trusted keys.
Step 6	[no] ntp authenticate Example: switch(config)# ntp authenticate	Enables or disables the NTP authentication feature. NTP authentication is disabled by default.
Step 7	(Optional) show ntp authentication-status Example: switch(config)# show ntp authentication-status	Displays the status of NTP authentication.
Step 8	(Optional) copy running-config startup-config Example: switch(config)# copy running-config startup-config	Copies the running configuration to the startup configuration.

3.7.6 Configuring NTP Access Restrictions

You can control access to NTP services by using access groups. Specifically, you can specify the types of requests that the device allows and the servers from which it accepts responses.

If you do not configure any access groups, NTP access is granted to all devices. If you configure any access groups, NTP access is granted only to the remote device whose source IP address passes the access list criteria.

Procedure

	Command or Action	Purpose
Step 1	configure terminal Example: switch# configure terminal	Enters global configuration mode.

	Command or Action	Purpose
	switch(config)#	
Step 2	[no] ntp access-group {peer serve serve-only query-only} access-list-name Example: switch(config)# ntp access-group peer accesslist1	Creates or removes an access group to control NTP access and applies a basic IP access list. ACL processing stops and does not continue to the next access group option if NTP matches a deny ACL rule in a configured peer. <ul style="list-style-type: none"> The peer keyword enables the device to receive time requests and NTP control queries and to synchronize itself to the servers specified in the access list. The serve keyword enables the device to receive time requests and NTP control queries from the servers specified in the access list but not to synchronize itself to the specified servers. The serve-only keyword enables the device to receive only time requests from servers specified in the access list. The query-only keyword enables the device to receive only NTP control queries from the servers specified in the access list.
Step 3	(Optional) show ntp access-groups Example: switch(config)# show ntp access-groups	Displays the NTP access group configuration.
Step 4	(Optional) copy running-config startup-config Example: switch(config)# copy running-config startup-config	Copies the running configuration to the startup configuration.

3.7.7 Configuring the NTP Source IP Address

NTP sets the source IP address for all NTP packets based on the address of the interface through which the NTP packets are sent. You can configure NTP to use a specific source IP address.

Procedure

	Command or Action	Purpose
Step 1	configure terminal Example: switch# configure terminal switch(config)#	Enters global configuration mode.
Step 2	[no] ntp source ip-address Example: switch(config)# ntp source 192.0.2.1	Configures the source IP address for all NTP packets. The <i>ip-address</i> can be in IPv4 or IPv6 format.
Step 3	(Optional) copy running-config startup-config Example: switch(config)# copy running-config startup-config	Copies the running configuration to the startup configuration.

3.7.8 Configuring the NTP Source Interface

You can configure NTP to use a specific interface.

Procedure

	Command or Action	Purpose
Step 1	configure terminal Example: switch# configure terminal switch(config)#	Enters global configuration mode.
Step 2	[no] ntp source-interface interface Example: switch(config)# ntp source-interface ethernet 2/1	Configures the source interface for all NTP packets. Use the ? keyword to display a list of supported interfaces.
Step 3	(Optional) copy running-config startup-config Example: switch(config)# copy running-config startup-config	Copies the running configuration to the startup configuration.

3.7.9 Configuring an NTP Broadcast Server

You can configure an NTP IPv4 broadcast server on an interface. The device then sends broadcast packets through that interface periodically. The client is not required to send a response.

Before you begin

Use the `switchto vdc` command to switch to the desired nondefault VDC.

Procedure

	Command or Action	Purpose
Step 1	configure t Example: switch# config t Enter configuration commands, one per line. End with CNTL/Z. switch(config)#	Enters global configuration mode.
Step 2	interface type slot/port Example: switch(config)# interface ethernet 6/1 switch(config-if)#	Enters interface configuration mode.
Step 3	Required: [no] ntp broadcast [destination ip-address] [key key-id] [version number] Example: switch(config-if)# ntp broadcast destination 192.0.2.10	Enables an NTP IPv4 broadcast server on the specified interface. <ul style="list-style-type: none"> destination <i>ip-address</i>—Configures the broadcast destination IP address. key <i>key-id</i>—Configures the broadcast authentication key number. The range is from 1 to 65535. version <i>number</i>—Configures the NTP version. The range is from 2 to 4.
Step 4	Required: exit Example: switch(config-if)# exit	Exits interface configuration mode.

	Command or Action	Purpose
	switch(config)#	
Step 5	(Optional) [no] ntp broadcastdelay <i>delay</i> Example: switch(config)# ntp broadcastdelay 100	(Optional) Configures the estimated broadcast round-trip delay in microseconds. The range is from 1 to 999999.
Step 6	(Optional) copy running-config startup-config Example: switch(config)# copy running-config startup-config	(Optional) Saves the change persistently through reboots and restarts by copying the running configuration to the startup configuration.

Example

This example shows how to configure an Ethernet interface to send NTP broadcast packets:

```
switch# configure terminal
switch(config)# interface ethernet6/1
switch(config-if)# ntp broadcast 192.0.2.10
```

3.7.10 Configuring an NTP Multicast Server

You can configure an NTP IPv4 or IPv6 multicast server on an interface. The device then sends multicast packets through that interface periodically.

Before you begin

Use the switchto vdc command to switch to the desired nondefault VDC.

Procedure

	Command or Action	Purpose
Step 1	configure t Example: switch# config t Enter configuration commands, one per line. End with CNTL/Z. switch(config)#	Enters global configuration mode.
Step 2	interface type slot/port Example: switch(config)# interface ethernet 6/1 switch(config-if)#	Enters interface configuration mode.
Step 3	Required: [no] ntp multicast [<i>ipv4-address</i> <i>ipv6-address</i>] [key <i>key-id</i>] [ttl <i>value</i>] [version <i>number</i>] Example: switch(config-if)# ntp multicast FF02:1::FF0E:8C6C	Enables an NTP IPv6 broadcast server on the specified interface. <ul style="list-style-type: none"> destination <i>ip-address</i>—Configures the broadcast destination IP address. key <i>key-id</i>—Configures the broadcast authentication key number. The range is from 1 to 65535. ttl <i>value</i>—The time-to-live value of the multicast packets. The range is from 1 to 255. version <i>number</i>—Configures the NTP version. Note For an IPv4 multicast server, the range is from 2 to 4.

	Command or Action	Purpose
Step 4	(Optional) copy running-config startup-config Example: switch(config)# copy running-config startup-config	(Optional) Saves the change persistently through reboots and restarts by copying the running configuration to the startup configuration.

Example

This example shows how to configure an Ethernet interface to send NTP multicast packets:

```
switch# configure terminal
switch(config)# interface ethernet2/2
switch(config-if)# ntp multicast FF02::1:FF0E:8C6C
```

3.7.11 Configuring an NTP Multicast Client

You can configure an NTP multicast client on an interface. The device then listens to NTP multicast messages and discards any messages that come from an interface for which multicast is not configured.

Before you begin

Use the `switchto vdc` command to switch to the desired nondefault VDC

Procedure

	Command or Action	Purpose
Step 1	configure t Example: switch# config t Enter configuration commands, one per line. End with CNTL/Z. switch(config)#	Enters global configuration mode.
Step 2	interface type slot/port Example: switch(config)# interface ethernet 6/1 switch(config-if)#	Enters interface configuration mode.
Step 3	Required: [no] ntp multicast client [ipv4-address ipv6-address] Example: switch(config-if)# ntp multicast FF02:1::FF0E:8C6C	Enables an NTP IPv6 broadcast server on the specified interface.
Step 4	(Optional) copy running-config startup-config Example: switch(config)# copy running-config startup-config	(Optional) Saves the change persistently through reboots and restarts by copying the running configuration to the startup configuration.

3.7.12 Configuring NTP on a Secondary (Non-Default) VDC

You can configure a non-default VDC to get a timing update from the default VDC and its clients in order to synchronize with it.

Procedure

	Command or Action	Purpose
Step 1	switch# configure terminal	Enters global configuration mode.
Step 2	switch(config)# feature ntp	Enables NTP in the non-default VDC.
Step 3	switch(config)# ntp master	Configures the device as an authoritative NTP server.
Step 4	(Optional) switch(config)# ntp source-interface interface	Configures the source interface for all NTP packets. The following list contains the valid values for <i>interface</i> . <ul style="list-style-type: none"> • ethernet • loopback • mgmt • port-channel • vlan
Step 5	(Optional) [no] ntp source ip-address	Configures the source IP address for all NTP packets. The <i>ip-address</i> can be in IPv4 or IPv6 format.
Step 6	(Optional) switch(config)# copy running-config startup-config	Saves the change persistently through reboots and restarts by copying the running configuration to the startup configuration.

Example

This examples show how to configure NTP on a secondary (non-default) VDC.

```
switch# configure terminal
switch(config)# feature ntp
switch(config)# ntp master
switch(config)# ntp source-interface ethernet
switch(config)# ntp source 192.0.2.2
switch(config)# copy running-config startup-config
```

3.7.13 Configuring NTP Logging

You can configure NTP logging in order to generate system logs with significant NTP events. NTP logging is disabled by default.

Procedure

	Command or Action	Purpose
Step 1	configure terminal Example: switch# configure terminal switch(config)#	Enters global configuration mode.
Step 2	[no] ntp logging Example: switch(config)# ntp logging	Enables or disables system logs to be generated with significant NTP events. NTP logging is disabled by default.
Step 3	(Optional) show ntp logging-status Example: switch(config)# show ntp logging-status	Displays the NTP logging configuration status.
Step 4	(Optional) copy running-config startup-config Example: switch(config)# copy running-config startup-config	Copies the running configuration to the startup configuration.

3.7.14 Enabling CFS Distribution for NTP

You can enable CFS distribution for NTP in order to distribute the NTP configuration to other CFS-enabled devices.

Before you begin

Make sure that you have enabled CFS distribution for the device.

Procedure

	Command or Action	Purpose
Step 1	switch# configure terminal	Enters global configuration mode.
Step 2	switch(config)# [no] ntp distribute	Enables or disables the device to receive NTP configuration updates that are distributed through CFS.
Step 3	(Optional) switch(config)# show ntp status	Displays the NTP CFS distribution status.
Step 4	(Optional) switch(config)# copy running-config startup-config	Saves the change persistently through reboots and restarts by copying the running configuration to the startup configuration.

Example

This example shows how to enable the device to receive NTP configuration updates through CFS:

```
switch# configure terminal
switch(config)# ntp
distribute
switch(config)# copy running-config startup-
config
```

3.7.15 Committing NTP Configuration Changes

When you commit the NTP configuration changes, the effective database is overwritten by the configuration changes in the pending database and all the devices in the network receive the same configuration.

Procedure

	Command or Action	Purpose
Step 1	switch# configure terminal	Enters global configuration mode.
Step 2	switch(config)# ntp commit	Distributes the NTP configuration changes to all Inspur INOS devices in the network and releases the CFS lock. This command overwrites the effective database with the changes made to the pending database.

3.7.16 Discarding NTP Configuration Changes

After making the configuration changes, you can choose to discard the changes instead of committing them. If you discard the changes, Inspur INOS removes the pending database changes and releases the CFS lock.

Procedure

	Command or Action	Purpose
--	-------------------	---------

Step 1	switch# configure terminal	Enters global configuration mode.
Step 2	switch(config)# ntp abort	Discards the NTP configuration changes in the pending database and releases the CFS lock. Use this command on the device where you started the NTP configuration.

3.7.17 Releasing the CFS Session Lock

If you have performed an NTP configuration and have forgotten to release the lock by either committing or discarding the changes, you or another administrator can release the lock from any device in the network. This action also discards pending database changes.

Procedure

	Command or Action	Purpose
Step 1	switch# configure terminal	Enters global configuration mode.
Step 2	switch(config)# clear ntp session	Discards the NTP configuration changes in the pending database and releases the CFS lock.

3.8 Verifying the NTP Configuration

To display the NTP configuration, perform one of the following tasks:

Command	Purpose
show ntp access-groups	Displays the NTP access group configuration.
show ntp authentication-keys	Displays the configured NTP authentication keys.
show ntp authentication-status	Displays the status of NTP authentication.
show ntp internal	Displays internal NTP information.
show ntp logging-status	Displays the NTP logging status.
show ntp peer-status	Displays the status for all NTP servers and peers.
show ntp peers	Displays all the NTP peers.
show ntp rts-update	Displays the RTS update status.
show ntp source	Displays the configured NTP source IP address.
show ntp source-interface	Displays the configured NTP source interface.
show ntp statistics {io local memory peer {ipaddr {ipv4-addr ipv6-addr} name peer-name}}	Displays the NTP statistics.
show ntp trusted-keys	Displays the configured NTP trusted keys.
show running-config ntp	Displays NTP information.

Use the `clear ntp session` command to clear the NTP sessions.

Use the `clear ntp statistics` command to clear the NTP statistics.

3.9 Configuration Examples for NTP

This example shows how to configure an NTP server and peer, enable NTP authentication, enable NTP logging, and then save the configuration in startup so that it is saved across reboots and restarts:

```
switch# configure terminal
Enter configuration commands, one per line. End with CNTL/Z.
switch(config)# ntp server 192.0.2.105 key 42
switch(config)# ntp peer 2001:0db8::4101
switch(config)# show ntp peers
```

```

-----
Peer IP Address Serv/Peer
-----
2001:db8::4101 Peer (configured)
192.0.2.105 Server (configured)
switch(config)# ntp authentication-key 42 md5 aNiceKey
switch(config)# show ntp authentication-keys
-----

Auth key MD5 String
-----
42 aNicekey
switch(config)# ntp trusted-key 42
switch(config)# show ntp trusted-keys
Trusted Keys:
42
switch(config)# ntp authenticate
switch(config)# show ntp authentication-status
Authentication enabled.
switch(config)# ntp logging
switch(config)# show ntp logging
NTP logging enabled.
switch(config)# copy running-config startup-config
[#####] 100%
switch(config)#

```

This example shows an NTP access group configuration with the following restrictions:

- Peer restrictions are applied to IP addresses that pass the criteria of the access list named “peer-acl.”
- Serve restrictions are applied to IP addresses that pass the criteria of the access list named “serve-acl.”
- Serve-only restrictions are applied to IP addresses that pass the criteria of the access list named “serve-only-acl.”
- Query-only restrictions are applied to IP addresses that pass the criteria of the access list named “query-only-acl.”

```

switch# configure terminal
switch(config)# ntp peer 10.1.1.1
switch(config)# ntp peer 10.2.2.2
switch(config)# ntp peer 10.3.3.3
switch(config)# ntp peer 10.4.4.4
switch(config)# ntp peer 10.5.5.5
switch(config)# ntp peer 10.6.6.6
switch(config)# ntp peer 10.7.7.7
switch(config)# ntp peer 10.8.8.8
switch(config)# ntp access-group peer peer-acl
switch(config)# ntp access-group serve serve-acl
switch(config)# ntp access-group serve-only serve-only-acl
switch(config)# ntp access-group query-only query-only-acl
switch(config)# ip access-list peer-acl
switch(config-acl)# 10 permit ip host 10.1.1.1 any
switch(config-acl)# 20 permit ip host 10.8.8.8 any
switch(config)# ip access-list serve-acl
switch(config-acl)# 10 permit ip host 10.4.4.4 any
switch(config-acl)# 20 permit ip host 10.5.5.5 any
switch(config)# ip access-list serve-only-acl
switch(config-acl)# 10 permit ip host 10.6.6.6 any
switch(config-acl)# 20 permit ip host 10.7.7.7 any
switch(config)# ip access-list query-only-acl
switch(config-acl)# 10 permit ip host 10.2.2.2 any
switch(config-acl)# 20 permit ip host 10.3.3.3 any

```

3.10 Additional References

3.10.1 Related Documents

Related Topic	Document Title
Clock manager	<i>Inspur CN12700 Series INOS Fundamentals Configuration Guide</i>
NTP CLI commands	<i>Inspur CN12700 Series INOS System Management Command Reference</i>
VDCs and VRFs	<i>Inspur CN12700 Series INOS Virtual Device Context Configuration Guide</i>

3.11 Feature History for NTP

The table below summarizes the new and changed features for this document and shows the releases in which each feature is supported. Your software release might not support all the features in this document. For the latest caveats and feature information, the release notes for your software release.

Table 5 Feature History for NTP

Feature Name	Releases	Feature Information
NTP	7.3(0)D1(1)	Increased the length of NTP authentication keys from 15 to 32 alphanumeric characters.
NTP	6.2(2)	Introduced the ntp access-group match-all command to cause the access group options to be scanned in order, from least restrictive to most restrictive.
NTP	6.2(2)	Introduced the no ntp passive command to prevent NTP from forming associations.
NTP	6.2(2)	Added the ability to configure NTP broadcast and multicast servers and multicast clients on an interface.
NTP	6.2(2)	Added the ability to enable or disable NTP on an interface.
NTP	6.1(1)	NTP access group options are now scanned in order from least restrictive to most restrictive.
NTP	6.1(1)	Increased the length of NTP authentication keys from 8 to 15 alphanumeric characters.
NTP	5.2(3)	Increased the length of NTP authentication keys from 8 to 15 alphanumeric characters.
NTP	5.2(1)	Added NTP support for all VDCs, enabling them to act as time servers.
NTP	5.2(1)	Changed the command to enable or disable NTP from [no] ntp enable to [no] feature ntp .
NTP	5.2(1)	Added the ability to configure the device as an authoritative NTP server, enabling it to distribute time even when it is not synchronized to an existing time server.
NTP access groups	5.2(1)	Added the serve , serve-only , and query-only access group options to control access to additional NTP services.
NTP access groups	5.0(2)	Added the ability to control access to NTP services by using access groups.
NTP authentication	5.0(2)	Added the ability to enable or disable NTP authentication.
NTP logging	5.0(2)	Added the ability to enable or disable NTP logging.
NTP server configuration	5.0(2)	Added the optional key keyword to the ntp server command to configure a key to be used while communicating with the NTP server.
CFS support	4.2(1)	Added the ability to distribute NTP configuration using CFS.

NTP source IP address or interface	4.1(3)	Added the ability set the source IP address or source interface that NTP includes in all NTP packets sent to peers.
NTP	4.0(3)	Added the ability to disable NTP.

CHAPTER 4 Configuring PTP

This chapter describes how to configure the Precision Time Protocol (PTP) on Inspur INOS devices. This chapter includes the following sections:

- Finding Feature Information
- About PTP
- Virtualization Support
- Licensing Requirements for PTP
- Prerequisites for PTP
- Guidelines and Limitations for PTP
- Default Settings for PTP
- Configuring PTP
- Verifying the PTP Configuration
- Configuration Examples for PTP
- Related Documents
- Feature History for PTP

4.1 Finding Feature Information

Your software release might not support all the features documented in this module. For the latest caveats and feature information, the release notes for your software release. To find information about the features documented in this module, and to see a list of the releases in which each feature is supported, see the "New and Changed Information" chapter or the Feature History table in this chapter.

4.2 About PTP

PTP is a time synchronization protocol for nodes distributed across a network. Its hardware timestamp feature provides greater accuracy than other time synchronization protocols such as the Network Time Protocol (NTP).

Beginning with Inspur INOS Release 7.3(0)D1(1), PTP also implements IEEE 802.1AS to support Audio Video Bridging (AVB) on CN12700 platform for F3 line cards.

A PTP system can consist of a combination of PTP and non-PTP devices. PTP devices include ordinary clocks, boundary clocks, and transparent clocks. Non-PTP devices include ordinary network switches, routers, and other infrastructure devices.

PTP is a distributed protocol that specifies how real-time PTP clocks in the system synchronize with each other. These clocks are organized into a master-slave synchronization hierarchy with the grandmaster clock, which is the clock at the top of the hierarchy, determining the reference time for the entire system.

Synchronization is achieved by exchanging PTP timing messages, with the members using the timing information to adjust their clocks to the time of their master in the hierarchy. PTP operates within a logical scope called a PTP domain.

4.2.1 PTP Device Types

The following clocks are common PTP devices:

Ordinary clock

Communicates with the network based on a single physical port, similar to an end host. An ordinary clock can function as a grandmaster clock.

Boundary clock

Typically has several physical ports, with each port behaving like a port of an ordinary clock. However, each port shares the local clock, and the clock data sets are common to all ports. Each port decides its individual state, either master (synchronizing other ports connected to it) or slave (synchronizing to a downstream port), based on the best clock available to it through all of the other ports on the boundary clock. Messages related to synchronization and establishing the master-slave hierarchy terminate in the protocol engine of a boundary clock and are not forwarded.

Transparent clock

Forwards all PTP messages like an ordinary switch or router but measures the residence time of a packet in the switch (the time that the packet takes to traverse the transparent clock) and in some cases the link delay of the ingress port for the packet. The ports have no state because the transparent clock does not need to synchronize to the grandmaster clock.

There are two kinds of transparent clocks:

End-to-end transparent clock

Measures the residence time of a PTP message and accumulates the times in the correction field of the PTP message or an associated follow-up message.

Peer-to-peer transparent clock

Measures the residence time of a PTP message and computes the link delay between each port and a similarly equipped port on another node that shares the link. For a packet, this incoming link delay is added to the residence time in the correction field of the PTP message or an associated follow-up message.

4.2.2 PTP Process

The PTP process consists of two phases: establishing the master-slave hierarchy and synchronizing the clocks. Within a PTP domain, each port of an ordinary or boundary clock follows this process to determine its state:

- Examines the contents of all received announce messages (issued by ports in the master state)
- Compares the data sets of the foreign master (in the announce message) and the local clock for priority, clock class, accuracy, and so on
- Determines its own state as either master or slave

After the master-slave hierarchy has been established, the clocks are synchronized as follows:

- The master sends a synchronization message to the slave and notes the time it was sent.
- The slave receives the synchronization message and notes the time that it was received. For every synchronization message, there is a follow-up message. Hence, the number of sync messages should be equal to the number of follow-up messages.
 - The slave sends a delay-request message to the master and notes the time it was sent.
 - The master receives the delay-request message and notes the time it was received.
 - The master sends a delay-response message to the slave. The number of delay request messages should be equal to the number of delay response messages.
 - The slave uses these timestamps to adjust its clock to the time of its master.

4.2.3 Pong

The network-monitoring tool Pong leverages the PTP's time synchronization infrastructure to diagnose the health of the network. Pong measures port-to-port delays and is similar to the network-monitoring utility Ping but provides for a greater depth of network diagnostics. Make sure to increase the interface MTU when you attempt pong to a destination that is several hops away.

4.2.4 Clock Manager

Clocks are resources that need to be shared across different processes and across different VDCs. Multiple time synchronization protocols (such as NTP and PTP) might be running in the system, and multiple instances of the same protocol might be running in different VDCs. The clock manager allows you to specify the protocol and a VDC running that protocol to control the various clocks in the system.

4.2.5 High Availability for PTP

Stateful restarts are supported for PTP. After a reboot or a supervisor switchover, the running configuration is applied. For more information on high availability, see the Inspur CN12700 Series INOS High Availability and Redundancy Guide.

4.3 Virtualization Support

Inspur INOS supports multiple instances of PTP, one instance per virtual device context (VDC). By default, Inspur INOS places you in the default VDC unless you specifically configure another VDC. For more information about VDCs, see the Inspur CN12700 Series INOS Virtual Device Context Configuration Guide.

4.4 Licensing Requirements for PTP

PTP requires no license. Any feature not included in a license package is bundled with the Inspur INOS system images and is provided at no extra charge to you. For a complete explanation of the Inspur INOS licensing scheme, see the Inspur INOS Licensing Guide.

4.5 Prerequisites for PTP

PTP has the following prerequisites:

- To configure VDCs, you must install the appropriate license. See the Inspur CN12700 Series INOS Virtual Device Context Configuration Guide for configuration information and the Inspur INOS Licensing Guide for licensing information.

4.6 Guidelines and Limitations for PTP

- PTP operates only in boundary clock mode. and in gPTP mode to support AVB. The end-to-end transparent clock and peer-to-peer transparent clock modes are not supported.
- Only one PTP process can control all of the port clocks through the clock manager.
- PTP supports transport over User Datagram Protocol (UDP).
- Transport over Ethernet is supported on AVB application.
- PTP supports only multicast communication. Negotiated unicast communication is supported on AVB application.
- PTP is limited to a single domain per network.
- All management messages are forwarded on ports on which PTP is enabled. Handling management messages is not supported.
- PTP-capable ports do not identify PTP packets and do not time-stamp or redirect those packets unless you enable PTP on those ports.
- PTP can be enabled on F1, F2, F2e, F3, F4, M2, and M3 Series module ports.
- PTP is not supported on the breakout ports, logical interfaces, sub interfaces, and FEX interfaces.

- For F1 Series modules, PTP is not supported on the port if priority flow control is enabled. Similarly, priority flow control is not supported if PTP is enabled on the same port.
- For F1 Series modules, Pong is not supported on the VDC if priority flow control is enabled on any of the ports in the same VDC. Similarly, priority flow control is not supported if Pong is enabled in the same VDC.
- Beginning with Inspur INOS Release 6.1, PTP is supported in Layer 3 mode for F2, F2e, and M2 Series modules.
 - Beginning with Inspur INOS Release 6.2.6, PTP is supported in F3 Series modules.
 - PTP Encapsulation is supported starting from in Inspur CN 7.3.0. The default value is Layer 3.
 - PTP over FabricPath is not supported.
 - Starting from Inspur INOS Release 8.2(1), PTP can be enabled on M3-Series I/O modules.
 - Starting from Inspur INOS Release 8.4(1) Pong is supported on M3 Series modules.
 - Starting from Inspur INOS Release 8.4(1), PTP can be enabled on F4-Series I/O modules.

4.7 Default Settings for PTP

The following table lists the default settings for PTP parameters.

Table 6 Default PTP Parameters

Parameters	Default
PTP	Disabled
PTP version	2
PTP domain	0
PTP priority 1 value when advertising the clock	255
PTP priority 2 value when advertising the clock	255
PTP announce interval	1 log second
PTP announce timeout	3 announce intervals
PTP minimum delay request interval	0 log seconds
PTP VLAN	1

4.8 Configuring PTP

4.8.1 Configuring PTP Globally

You can enable or disable PTP globally on a device. You can also configure various PTP clock parameters to help determine which clock in the network has the highest priority to be selected as the grandmaster.

Procedure

	Command or Action	Purpose
Step 1	switch# configure terminal	Enters global configuration mode.
Step 2	switch(config) # [no] feature ptp	Enables or disables PTP on the device. Note Enabling PTP on the switch does not enable PTP on each interface.
Step 3	switch(config) # [no] ptp source ip-address	Configures the source IP address for all PTP packets. The <i>ip-address</i> can be in IPv4 or IPv6 format.
Step 4	(Optional) switch(config) # [no] ptp domain number	Configures the domain number to use for this clock. PTP domains allow you to use multiple

	Command or Action	Purpose
		independent PTP clocking subdomains on a single network. The range for the <i>number</i> is from 0 to 128.
Step 5	(Optional) switch(config) # [no] ptp priority1 <i>value</i>	Configures the priority1 value to use when advertising this clock. This value overrides the default criteria (clock quality, clock class, and etc.) for best master clock selection. Lower values take precedence. The range for the <i>value</i> is from 0 to 255.
Step 6	(Optional) switch(config) # [no] ptp priority2 <i>value</i>	Configures the priority2 value to use when advertising this clock. This value is used to decide between two devices that are otherwise equally matched in the default criteria. For example, you can use the priority2 value to give a specific switch priority over other identical switches. The range for the <i>value</i> is from 0 to 255.
Step 7	(Optional) switch(config) # [no] ptp encapsulation {layer-2 layer-3}	Configures the encapsulation that is to be used for PTP. In Layer 3 encapsulation, PTP packets are encapsulated with IP + UDP frame. In Layer 2 encapsulation, PTP packets are encapsulated within the Ethernet frame. The default PTP encapsulation is Layer-3; PTP mode is Boundary. Layer 2 encapsulation is supported only with AVB.
Step 8	(Optional) switch(config) # [no] ptp mode {boundary-clock generalized-PTP transparent-clock peer-to-peer}	Configures the PTP device mode. The default mode is <i>boundary-clock</i> . The generalized-PTP mode is used for AVB. The transparent-clock <i>peer-to-peer mode</i> is added for experimental purpose, not supported officially.
Step 9	(Optional) switch(config) # [no] ptp switchlatency-estimated <i>value</i>	Configures the maximum estimate switch latency value in nano-secs (ns). This value is used in AVB. The range is 0 - 2147483647. The default value is 5000.
Step 10	(Optional) switch(config) # [no] show ptp clock foreign-masters record [interface ethernet slot/ port]	Displays information about foreign masters.
Step 11	(Optional) switch(config) # [no] show ptp delay summary	Displays link delay and residency delay information for all interfaces. It is used in AVB.
Step 12	(Optional) switch(config) # [no] show ptp parent	Displays parent clock information.
Step 13	(Optional) switch(config) # [no] show ptp time-property	Displays local clock time property information.
Step 14	(Optional) switch(config) # [no] show ptp corrections	Displays the latest few corrections on this node.
Step 15	(Optional) switch(config) # show ptp brief	Displays the PTP status.
Step 16	(Optional) switch(config) # show ptp clock	Displays the properties of the local clock.
Step 17	(Optional) switch(config) # show ptp clock	Displays the properties of the local clock.

Example

This example shows how to configure PTP globally on the device, specify the source IP address for PTP communications, and configure a preference level for the clock:

```
switch# configure terminal
switch(config)# feature ptp
switch(config)# ptp source 10.10.10.1
switch(config)# ptp priority1 1
switch(config)# ptp priority2 1
switch(config)# show ptp brief
PTP port status
-----
Port State
-----
switch(config)# show ptp clock
PTP Device Type: Boundary clock
Clock Identity : 0:22:55:ff:ff:79:a4:c1
Clock Domain: 0
Number of PTP ports: 0
Priority1 : 1
Priority2 : 1
Clock Quality:
Class : 248
Accuracy : 254
Offset (log variance) : 65535
Offset From Master : 0
Mean Path Delay : 0 Steps removed : 0
Local clock time:Sun Jul 3 14:13:24 2011
switch(config)#
```

4.8.2 Configuring PTP on an Interface

After you globally enable PTP, it is not enabled on all supported interfaces by default. You must enable PTP interfaces individually.

Before you begin

Make sure that you have globally enabled PTP on the switch and configured the source IP address for PTP communication.

Procedure

	Command or Action	Purpose
Step 1	switch# configure terminal	Enters global configuration mode.
Step 2	switch(config) # interface ethernet slot/port	Specifies the interface on which you are enabling PTP and enters the interface configuration mode.
Step 3	switch(config-if) # [no] ptp	Enables or disables PTP on an interface.
Step 4	(Optional) switch(config-if) # [no] ptp announce {interval log seconds timeout count}	Configures the interval between PTP announce messages on an interface or the number of PTP intervals before a timeout occurs on an interface. The range for the PTP announcement interval is from 0 to 4 seconds, and the range for the interval timeout is from 2 to 10.
Step 5	(Optional) switch(config-if) # [no] ptp delay request minimum interval log seconds	Configures the minimum interval allowed between PTP delay-request messages when the port is in the master state.

	Command or Action	Purpose
		The range is from log(-6) to log(1) seconds. Where, log(-2) = 2 frames per second.
Step 6	(Optional) switch(config-if) # [no] ptp sync interval log seconds	Configures the interval between PTP synchronization messages on an interface.
Step 7	(Optional) switch(config-if) # [no] ptp vlan vlan-id	Specifies the VLAN for the interface where PTP is being enabled. You can only enable PTP on one VLAN on an interface. The range is from 1 to 4094.
Step 8	(Optional) switch(config-if) # show ptp brief	Displays the PTP status.
Step 9	(Optional) switch(config-if) # show ptp port interface interface slot/port	Displays the status of the PTP port.
Step 10	(Optional) switch(config-if)# copy running-config startup-config	Saves the change persistently through reboots and restarts by copying the running configuration to the startup configuration.

Example

This example shows how to configure PTP on an interface and configure the intervals for the announce, delay-request, and synchronization messages:

```
switch# configure terminal
switch(config)# interface ethernet 2/1
switch(config-if)# ptp
switch(config-if)# ptp announce interval 3
switch(config-if)# ptp announce timeout 2
switch(config-if)# ptp delay-request minimum interval 4
switch(config-if)# ptp sync interval -1
switch(config-if)# show ptp brief
PTP port status
-----
Port State
-----
Eth2/1 Master
switch(config-if)# show ptp port interface ethernet 2/1
PTP Port Dataset: Eth2/1
Port identity: clock identity: 0:22:55:ff:ff:79:a4:c1
Port identity: port number: 1028
PTP version: 2 Port
state: Master
Delay request interval(log mean): 4
Announce receipt time out: 2
Peer mean path delay: 0 Announce
interval(log mean): 3 Sync
interval(log mean): -1 Delay
Mechanism: End to End
Peer delay request interval(log mean): 0
switch(config-if)#
```

4.9 Verifying the PTP Configuration

Use one of the following commands to verify the configuration:

Table 7 PTP Show Commands

Command	Purpose
show ptp brief	Displays the PTP status.

Command	Purpose
show ptp clock	Displays the properties of the local clock, including clock identity.
show ptp clock foreign-masters-record	Displays the state of foreign masters known to the PTP process. For each foreign master, the output displays the clock identity, basic clock properties, and whether the clock is being used as a grandmaster.
show ptp corrections	Displays the last few PTP corrections.
show ptp parent	Displays the properties of the PTP parent.
show ptp port interface ethernet slot/port	Displays the status of the PTP port on the switch.

4.10 Configuration Examples for PTP

This example shows how to configure PTP globally on the device, specify the source IP address for PTP communications, and configure a preference level for the clock:

```
switch# config t
switch(config)# feature ptp
switch(config)# ptp source 10.10.10.1
switch(config)# ptp priority1 1
switch(config)# ptp priority2 1
switch(config)# show ptp brief
PTP port status
-----
Port          State
-----
switch(config)# show ptp clock
PTP Device Type: Boundary clock
Clock Identity : 0:22:55:ff:fe:79:a4:c1
Clock Domain: 0
Number of PTP ports: 0
Priority1 : 1
Priority2 : 1
Clock Quality:
  Class : 248
  Accuracy : 254
  Offset (log variance) : 65535
  Offset From Master : 0
Mean Path Delay : 0
Steps removed : 0
Local clock time:Sun Jul 3 14:13:24 2011
```

This example shows how to configure PTP on an interface and configure the intervals for the announce, delay-request, and synchronization messages:

```
switch# config t
switch(config)# interface ethernet 2/1
switch(config-if)# ptp
switch(config-if)# ptp announce interval 3
switch(config-if)# ptp announce timeout 2
switch(config-if)# ptp delay-request minimum interval 4
switch(config-if)# ptp sync interval -1
switch(config-if)# show ptp brief
PTP port status
-----
Port      State
-----
Eth2/1    Master
switch(config-if)# show ptp port interface ethernet 2/1
```

```

PTP Port Dataset: Eth2/1
Port identity: clock identity: 0:22:55:ff:fe:79:a4:c1
Port identity: port number: 1028
PTP version: 2 Port
state: Master
Delay request interval(log mean): 4
Announce receipt time out: 2
Peer mean path delay: 0 Announce
interval(log mean): 3 Sync
interval(log mean): -1 Delay
Mechanism: End to End
Peer delay request interval(log mean): 0

```

4.11 Related Documents

Related Topic	Document Title
PTP CLI commands	<i>Inspur CN12700 Series INOS System Management Command Reference</i>
Pong	<i>Inspur CN12700 Series INOS Troubleshooting Guide</i>
Clock manager	<i>Inspur CN12700 Series INOS Fundamentals Configuration Guide</i>
VDCs	<i>Inspur CN12700 Series INOS Virtual Device Context Configuration Guide</i>

4.11.1 Related Documents

Related Topic	Document Title
PTP CLI commands	<i>Inspur CN12700 Series INOS System Management Command Reference</i>
VDCs	<i>Inspur CN12700 Series INOS Virtual Device Context Configuration Guide</i>
Pong	<i>Inspur CN12700 Series INOS Troubleshooting Guide</i>
Clock manager	<i>Inspur CN12700 Series INOS Fundamentals Configuration Guide</i>

4.12 Feature History for PTP

The table below summarizes the new and changed features for this document and shows the releases in which each feature is supported. Your software release might not support all the features in this document. For the latest caveats and feature information, the release notes for your software release.

Table 8 Feature History for PTP

Feature Name	Releases	Feature Information
Pong	8.4(1)	Added Pong support for M3 Series modules.
PTP	8.4(1)	Added PTP support for F4-Series I/O modules.
PTP	8.2(1)	Added PTP support for M3-Series I/O modules.
PTP	7.3(0)D1(1)	Added support for AVB, 802.1AS, generalized-ptp mode, peer-delay-response mechanism, layer-2 encapsulation only for F3 line cards on CN12700 chassis. For details, refer to " <i>Inspur CN AVB configuration Guide</i> ".
PTP	6.2(6)	Added support in F3 Series Modules.
PTP	6.1(1)	Added PTP support in Layer 3 mode for F2, F2e, and M2 Series modules.
PTP	6.1(1)	Added support for M2 Series modules.
PTP	6.1(1)	Changed the PTP MAC format from FF:FF to FF:FE.
PTP	6.1(1)	Deprecated the vrf option from the ptp source command.
PTP	6.0(1)	Added PTP support on port-channel member ports.
PTP	6.0(1)	Added support for F2 Series modules.
PTP	5.2(1)	This feature was introduced.

CHAPTER 5 Configuring CDP

This chapter describes how to configure the Inspur Discovery Protocol (CDP) on Inspur INOS devices. This chapter includes the following sections:

- Finding Feature Information
- About CDP
- Licensing Requirements for CDP
- Prerequisites for CDP
- Guidelines and Limitations for CDP
- Default Settings for CDP
- Configuring CDP
- Verifying the CDP Configuration
- Configuration Example for CDP
- Additional References
- Feature History for CDP

5.1 Finding Feature Information

Your software release might not support all the features documented in this module. For the latest caveats and feature information, the release notes for your software release. To find information about the features documented in this module, and to see a list of the releases in which each feature is supported, see the "New and Changed Information" chapter or the Feature History table in this chapter.

5.2 About CDP

The Inspur Discovery Protocol (CDP) is a media-independent and protocol-independent protocol that runs on all Inspur-manufactured equipment including routers, bridges, access and communication servers, and switches. You can use CDP to discover and view information about all the Inspur devices that are directly attached to the device.

CDP gathers protocol addresses of neighboring devices and discovers the platform of those devices. CDP runs over the data link layer only. Two systems that support different Layer 3 protocols can learn about each other.

Each device that you configure for CDP sends periodic advertisements to a multicast address. Each device advertises at least one address at which it can receive SNMP messages. The advertisements also contain hold-time information, which indicates the length of time that a receiving device should hold CDP information before removing it. You can configure the advertisement or refresh timer and the hold timer.

CDP Version-2 (CDPv2) allows you to track instances where the native VLAN ID or port duplex states do not match between connecting devices.

CDP advertises the following type-length-value fields (TLVs):

- Device ID
- Address
- Port ID
- Capabilities
- Version
- Platform
- Native VLAN
- Full/Half Duplex
- MTU
- SysName

- SysObjectID
- Management Address
- Physical Location
- VTP

All CDP packets include a VLAN ID. If you configure CDP on a Layer 2 access port, the CDP packets sent from that access port include the access port VLAN ID. If you configure CDP on a Layer 2 trunk port, the CDP packets sent from that trunk port include the lowest configured VLAN ID allowed on that trunk port. The trunk port can receive CDP packets that include any VLAN ID in the allowed VLAN list for that trunk port. For more information on VLANs, see the *Inspur CN12700 Series INOS Layer 2 Switching Configuration Guide*.

5.2.1 VTP Feature Support

CDP sends the VLAN Trunking Protocol (VTP) type-length-value field (TLV) if the following conditions are met:

- CDP Version 2 is enabled
- The VTP feature is enabled
- A VTP domain name is configured

You can view the VTP information with the `show cdp neighbors detail` command.

5.2.2 High Availability

Inspur INOS supports both stateful and stateless restarts and switchover for CDP. For more information on high availability, see the *Inspur CN12700 Series INOS High Availability and Redundancy Guide*.

5.2.3 Virtualization Support

Inspur INOS supports multiple instances of CDP, one instance per virtual device context (VDC). By default, Inspur INOS places you in the default VDC unless you specifically configure another VDC. For more information on VDCs, see the *Inspur CN12700 Series INOS Virtual Device Context Configuration Guide*.

5.3 Licensing Requirements for CDP

Product	License Requirement
Inspur INOS	CDP requires no license. Any feature not included in a license package is bundled with the INOS image and is provided at no extra charge to you. For a complete explanation of the Inspur INOS licensing scheme, see the <i>Inspur INOS Licensing Guide</i> .

5.4 Prerequisites for CDP

If you configure VDCs, install the appropriate license and enter the desired VDC. See the *Inspur CN12700 Series INOS Virtual Device Context Configuration Guide* for configuration information and the *Inspur INOS Licensing Guide* for licensing information.

5.5 Guidelines and Limitations for CDP

CDP has the following configuration guidelines and limitations:

- CDP can discover up to 256 neighbors per port if the port is connected to a hub with 256 connections.
- CDP must be enabled on the device or you cannot enable it on any interfaces.

- You can configure CDP on physical interfaces and port channels only.
- CDP is not supported for the Inspur CN3000 Series Fabric Extender.

5.6 Default Settings for CDP

This table lists the default settings for CDP parameters.

Parameters	Default
CDP	Enabled globally and on all interfaces
CDP version	Version 2
CDP device ID	Serial number
CDP timer	60 seconds
CDP hold timer	180 seconds

5.7 Configuring CDP

5.7.1 Enabling or Disabling CDP Globally

CDP is enabled by default. You can disable CDP and then reenable it.

You must enable CDP on the device before you enable CDP on any interfaces. If CDP is disabled globally and you enable CDP on specified interfaces, CDP will not be active on those interfaces; the system does not return an error message.

Procedure

	Command or Action	Purpose
Step 1	configure terminal Example: switch# configure terminal switch(config)#	Enters global configuration mode.
Step 2	[no] cdp enable Example: switch(config)# cdp enable	Enables or disables the CDP feature on the entire device. It is enabled by default.
Step 3	(Optional) copy running-config startup-config Example: switch(config)# copy running-config startup-config	Copies the running configuration to the startup configuration.

5.7.2 Enabling or Disabling CDP on an Interface

CDP is enabled by default on an interface. You can disable CDP on an interface.

If CDP is disabled globally and you enable CDP on specified interfaces, CDP will not be active on those interfaces; the system does not return an error message.

Procedure

	Command or Action	Purpose
Step 1	configure terminal Example:	Enters global configuration mode.

	Command or Action	Purpose
	switch# configure terminal switch(config)#	
Step 2	interface <i>interface slot/port</i> Example: switch(config)# interface ethernet 1/2 switch(config-if)#	Enters interface configuration mode.
Step 3	[no] cdp enable Example: switch(config-if)# cdp enable	Enables or disables CDP on this interface. It is enabled by default. Note Make sure that CDP is enabled globally on the device.
Step 4	(Optional) show cdp interface <i>interface slot/port</i> Example: switch(config-if)# show cdp interface ethernet 1/2	Displays CDP information for an interface.
Step 5	(Optional) copy running-config startup-config Example: switch(config)# copy running-config startup-config	Copies the running configuration to the startup configuration.

5.7.3 Configuring Optional CDP Parameters

You can use the optional commands in this procedure to modify CDP.

Procedure

	Command or Action	Purpose
Step 1	configure terminal Example: switch# configure terminal switch(config)#	Enters global configuration mode.
Step 2	(Optional) cdp advertise {v1 v2} Example: switch(config)# cdp advertise v1	Sets the CDP version supported by the device. The default is v2.
Step 3	(Optional) cdp format device-id { mac-address serial-number system-name } Example: switch(config)# cdp format device-id mac-address	Sets the CDP device ID. The options are as follows: <ul style="list-style-type: none"> • mac-address—The MAC address of the chassis. • serial-number—The chassis serial number/Organizationally Unique Identifier (OUI). • system-name—The system name or fully qualified domain name. The default is system-name .
Step 4	(Optional) cdp holdtime <i>seconds</i> Example: switch(config)# cdp holdtime 150	Sets the time that CDP holds onto neighbor information before removing it. The range is from 10 to 255 seconds. The default is 180 seconds.
Step 5	(Optional) cdp timer <i>seconds</i> Example:	Sets the refresh time when CDP sends advertisements to neighbors. The range is from 5

	Command or Action	Purpose
	switch(config)# cdp timer 50	to 254 seconds. The default is 60 seconds.
Step 6	(Optional) copy running-config startup-config Example: switch(config)# copy running-config startup-config	Copies the running configuration to the startup configuration.

5.8 Verifying the CDP Configuration

To display the CDP configuration, perform one of the following tasks:

Command	Purpose
show cdp all	Displays all interfaces that have CDP enabled.
show cdp entry {all name <i>entry-name</i> }	Displays the CDP database entries.
show cdp global	Displays the CDP global parameters.
show cdp interface <i>interface slot/port</i>	Displays the CDP interface status.
show cdp neighbors { <i>device-id</i> <i>interface interface slot/port</i> } [detail]	Displays the CDP neighbor status.
show cdp interface <i>interface slot/port</i>	Displays the CDP traffic statistics on an interface.

Use the clear cdp counters command to clear CDP statistics on an interface.

Use the clear cdp table command to clear the CDP cache for one or all interfaces.

5.9 Configuration Example for CDP

This example shows how to enable the CDP feature and configure the refresh and hold timers:

```
config t cdp enable cdp timer 50
cdp holdtime 100
```

This example shows how to display the CDP global parameters:

```
switch# show cdp neighbors

Capability Codes: R - Router, T - Trans-Bridge, B - Source-Route-Bridge S
                  - Switch, H - Host, I - IGMP, r - Repeater,
                  V - VoIP-Phone, D - Remotely-Managed-Device, s
                  - Supports-STP-Dispute

Device-ID         Local Intrfce   Hldtme Capability   Platform         Port ID
Mgmt-switch
                  mgmt0           148    R S I          WS-C4948-10GE   Gig1/37
switch88 (FOX1518GRE6)
                  Eth1/25         164    R S I s        N5K-C5596UP     Eth1/25
switch89 (FOX1518GQJ2)
                  Eth1/26         163    R S I s        N5K-C5596UP     Eth1/25
```

5.10 Feature History for CDP

The table below summarizes the new and changed features for this document and shows the releases in which each feature is supported. Your software release might not support all the features in this document. For the latest caveats and feature information, the release notes for your software release.

Table 9 Feature History for CDP

Feature Name	Releases	Feature Information
--------------	----------	---------------------

CDP support for VTP domain name	4.2(1)	CDP advertises the VLAN Trunking Protocol (VTP) type-length-value field (TLV) in CDP version-2 packets.
---------------------------------	--------	---

Configuring System Message Logging

This chapter describes how to configure system message logging on Inspur INOS devices. This chapter contains the following sections:

- Finding Feature Information
- About System Message Logging
- Licensing Requirements for System Message Logging
- Guidelines and Limitations for System Message Logging
- Default Settings for System Message Logging
- Configuring System Message Logging
- Verifying the System Message Logging Configuration
- Configuration Example for System Message Logging
- Additional References
- Feature History for System Message Logging

5.11 Finding Feature Information

Your software release might not support all the features documented in this module. For the latest caveats and feature information, the release notes for your software release. To find information about the features documented in this module, and to see a list of the releases in which each feature is supported, see the "New and Changed Information" chapter or the Feature History table in this chapter.

5.12 About System Message Logging

You can use system message logging to control the destination and to filter the severity level of messages that system processes generate. You can configure logging to terminal sessions, a log file, and syslog servers on remote systems.

System message logging is based on RFC 3164. For more information about the system message format and the messages that the device generates, see the Inspur INOS System Messages Reference.

By default, the device outputs messages to terminal sessions and logs system messages to a log file.

The following table describes the severity levels used in system messages. When you configure the severity level, the system outputs messages at that level and lower.

Table 10 System Message Severity Levels

Level	Description
0 – emergency	System unusable
1 – alert	Immediate action needed
2 – critical	Critical condition
3 – error	Error condition
4 – warning	Warning condition
5 – notification	Normal but significant condition
6 – informational	Informational message only
7 – debugging	Appears during debugging only

The device logs the most recent 100 messages of severity 0, 1, or 2 to the NVRAM log. You cannot configure logging to the NVRAM.

You can configure which system messages should be logged based on the facility that generated the message and its severity level.

5.12.1 Syslog Servers

The syslog servers run on remote systems that log system messages based on the syslog protocol. You can configure up to eight IPv4 or IPv6 syslog servers.

To support the same configuration of syslog servers on all switches in a fabric, you can use Inspur Fabric Services (CFS) to distribute the syslog server configuration.

5.12.2 Binary Tech Support

Binary tech support is a log-collecting framework that collects logs internally from all Inspur INOS processes that are running on the device. Enter the `show tech-support all binary uri` command to collect logs from across the entire device, including virtual device contexts (VDCs), and linecards. The logs are saved under one tarball that can be easily transferred for later analysis. If a line card fails during the log collection, binary tech support continues to collect logs from all remaining line cards and VDCs.

5.12.3 Virtualization Support

A virtual device context (VDC) is a logical representation of a set of system resources. System message logging applies only to the VDC where commands are entered.

5.13 Licensing Requirements for System Message Logging

Product	License Requirement
Inspur INOS	System message logging requires no license. Any feature not included in a license package is bundled with the INOS image and is provided at no extra charge to you. For a complete explanation of the Inspur INOS licensing scheme, see the <i>Inspur INOS Licensing Guide</i> .

5.14 Guidelines and Limitations for System Message Logging

System messages are logged to the console and the log file by default.

For the secure syslog server(s) to be reachable over in-band (non-management) interface, the CoPP profile may need tweaks especially when multiple logging servers are configured, and when lot of syslogs get generated in a short time (such as boot up, configuration application, and so on).

5.15 Default Settings for System Message Logging

The following table lists the default settings for the system message logging parameters.

Table 11 Default System Message Logging Parameters

Parameters	Default
Console logging	Enabled at severity level 2
Monitor logging	Enabled at severity level 5
Log file logging	Enabled to log messages at severity level 5
Module logging	Enabled at severity level 5
Facility logging	Enabled
Time-stamp units	Seconds
Syslog server logging	Disabled
Syslog server configuration distribution	Disabled

5.16 Configuring System Message Logging

5.16.1 Configuring System Message Logging to Terminal Sessions

You can configure the device to log messages by their severity level to console, Telnet, and SSH sessions. By default, logging is enabled for terminal sessions.

Procedure

	Command or Action	Purpose
Step 1	terminal monitor Example: switch# terminal monitor	Enables the device to log messages to the console.
Step 2	configure terminal Example: switch# configure terminal switch(config)#	Enters global configuration mode.
Step 3	[no] logging console [<i>severity-level</i>] Example: switch(config)# logging console 3	Configures the device to log messages to the console session based on a specified severity level or higher. A lower number indicates a higher severity level. Severity levels range from 0 to 7: <ul style="list-style-type: none"> • 0 – emergency • 1 – alert • 2 – critical • 3 – error • 4 – warning • 5 – notification • 6 – informational • 7 – debugging If the severity level is not specified, the default of 2 is used. The no option disables the device's ability to log messages to the console.
Step 4	(Optional) show logging console Example: switch(config)# show logging console	Displays the console logging configuration.
Step 5	[no] logging monitor [<i>severity-level</i>] Example: switch(config)# logging monitor 3	Enables the device to log messages to the monitor based on a specified severity level or higher. A lower number indicates a higher severity level. Severity levels range from 0 to 7: <ul style="list-style-type: none"> • 0 – emergency • 1 – alert • 2 – critical • 3 – error • 4 – warning • 5 – notification • 6 – informational • 7 – debugging The configuration applies to Telnet and SSH sessions. If the severity level is not specified, the default of 2 is used. The no option disables the device's ability to log messages to the Telnet and SSH sessions.

	Command or Action	Purpose
Step 6	(Optional) show logging monitor Example: switch(config)# show logging monitor	Displays the monitor logging configuration.
Step 7	[no] logging message interface type ethernet description Example: switch(config)# logging message interface type ethernet description	Enables you to add the description for physical Ethernet interfaces and subinterfaces in the system message log. The description is the same description that was configured on the interface. The no option disables the printing of the interface description in the system message log for physical Ethernet interfaces.
Step 8	(Optional) copy running-config startup-config Example: switch(config)# copy running-config startup-config	Copies the running configuration to the startup configuration.

5.16.2 Logging System Messages to a File

You can configure the device to log system messages to a file. By default, system messages are logged to the file `log:messages`.

Procedure

	Command or Action	Purpose
Step 1	configure terminal Example: switch# configure terminal switch(config)#	Enters global configuration mode.
Step 2	[no] logging logfile logfile-name severity-level [size bytes] Example: switch(config)# logging logfile my_log 6	Configures the name of the log file used to store system messages and the minimum severity level to log. When you configure a new logfile without specifying the size, the existing/previously specified logfile size is assigned and the default file size is not considered. A lower number indicates a higher severity level. Severity levels range from 0 to 7: <ul style="list-style-type: none"> • 0 – emergency • 1 – alert • 2 – critical • 3 – error • 4 – warning • 5 – notification • 6 – informational • 7 – debugging <p>You can optionally specify a maximum file size. The default severity level is 5, and the default file size is 4194304 bytes. The file size range is from 4096 to 4194304 bytes.</p>

	Command or Action	Purpose
Step 3	logging event {link-status trunk-status} {enable default} Example: switch# logging event link-status default switch(config)#	Logs interface events. <ul style="list-style-type: none"> • link-status—Logs all UP/DOWN and CHANGE messages. • trunk-status—Logs all TRUNK status messages. • enable—Specifies to enable logging to override the port level configuration. • default—Specifies that the default logging configuration is used by interfaces not explicitly configured.
Step 4	(Optional) show logging info Example: switch(config)# show logging info	Displays the logging configuration.
Step 5	(Optional) copy running-config startup-config Example: switch(config)# copy running-config startup-config	Copies the running configuration to the startup configuration.

5.16.3 Configuring Module and Facility Messages Logging

You can configure the severity level and time-stamp units of messages logged by modules and facilities.

Procedure

	Command or Action	Purpose
Step 1	configure terminal Example: switch# configure terminal switch(config)#	Enters global configuration mode.
Step 2	[no] logging module [severity-level] Example: switch(config)# logging module 3	Enables module log messages that have the specified severity level or higher. Severity levels range from 0 to 7: <ul style="list-style-type: none"> • 0 – emergency • 1 – alert • 2 – critical • 3 – error • 4 – warning • 5 – notification • 6 – informational • 7 – debugging If the severity level is not specified, the default of 5 is used. The no option disables module log messages.
Step 3	(Optional) show logging module Example: switch(config)# show logging module	Displays the module logging configuration.
Step 4	[no] logging level facility severity-level Example: switch(config)# logging level aaa 2	Enables logging messages from the specified facility that have the specified severity level or higher. Severity levels range from 0 to 7: <ul style="list-style-type: none"> • 0 – emergency • 1 – alert

	Command or Action	Purpose
		<ul style="list-style-type: none"> • 2 – critical • 3 – error • 4 – warning • 5 – notification • 6 – informational • 7 – debugging <p>To apply the same severity level to all facilities, use the all facility. For defaults, see the show logging level command.</p> <p>The no option resets the logging severity level for the specified facility to its default level. If you do not specify a facility and severity level, the device resets all facilities to their default levels.</p>
Step 5	(Optional) show logging level [<i>facility</i>] Example: switch(config)# show logging level aaa	Displays the logging level configuration and the system default level by facility. If you do not specify a facility, the device displays levels for all facilities.
Step 6	[no] logging timestamp { <i>microseconds</i> <i>milliseconds</i> <i>seconds</i> } Example: switch(config)# logging timestamp milliseconds	Sets the logging time-stamp units. By default, the units are seconds. Note This command applies to logs that are kept in the switch. It does not apply to the external logging server.
Step 7	(Optional) show logging timestamp Example: switch(config)# show logging timestamp	Displays the logging time-stamp units configured.
Step 8	(Optional) copy running-config startup-config Example: switch(config)# copy running-config startup-config	Copies the running configuration to the startup configuration.

5.16.4 Configuring Syslog Servers

You can configure up to eight syslog servers that reference remote systems where you want to log system messages.

Procedure

	Command or Action	Purpose
Step 1	configure terminal Example: switch# configure terminal switch(config)#	Enters global configuration mode.
Step 2	[no] logging server <i>host</i> [<i>severity-level</i> [use-vrf <i>vrf-name</i>]] Example: switch(config)# logging server 192.0.2.253 Example: switch(config)# logging server 2001:db8::3 5 use-vrf red	Configures a syslog server at the specified hostname or IPv4 or IPv6 address. You can limit logging of messages to a particular VRF by using the use-vrf keyword. Severity levels range from 0 to 7: <ul style="list-style-type: none"> • 0 – emergency • 1 – alert • 2 – critical

	Command or Action	Purpose
		<ul style="list-style-type: none"> • 3 – error • 4 – warning • 5 – notification • 6 – informational • 7 – debugging <p>The default outgoing facility is local7. The no option removes the logging server for the specified host. The first example forwards all messages on facility local 7. The second example forwards messages with severity level 5 or lower for VRF red.</p>
Step 3	logging source-interface <i>interface</i> Example: switch(config)# logging source-interface loopback 5	Sets the source interface whose IP address is displayed in the log messages. This static configuration ensures that same IP address appears in all log messages that are sent from an individual Inspur INOS device.
Step 4	(Optional) show logging server Example: switch(config)# show logging server	Displays the syslog server configuration. Note The output of this command will display the syslog server configuration details along with a message stating "This server is temporarily unreachable." Please ignore this message.
Step 5	(Optional) copy running-config startup-config Example: switch(config)# copy running-config startup-config	Copies the running configuration to the startup configuration.

5.16.5 Configuring Destination Port for Forwarding Syslogs

You can specify the destination port to be used while forwarding the system messages to the remote server where they will be logged.

Procedure

	Command or Action	Purpose
Step 1	configure terminal Example: switch# configure terminal switch(config)#	Enters global configuration mode.
Step 2	[no] logging server <i>host</i> [<i>severity-level</i> [use-vrf <i>vrf-name</i>]] Example: switch(config)# logging server 192.0.2.253 port 600 Example: switch(config)# logging server 192.0.2.253 5 port 600	Specifies the destination port on which the syslogs are forwarded to remote server. The port numbers range from 1 to 65535. The default destination port number is 514. Note To remove the custom destination port or to reset it to its default value, use the logging server command without specifying any port number. Optionally, you can specify the port number as 514. The first example forwards all messages on user-defined port number 600. The second example

	Command or Action	Purpose
		forwards messages with severity level 5 or lower on user-defined port number 600.
Step 3	(Optional) show logging server Example: switch(config)# show logging server	Displays the syslog server configuration.
Step 4	(Optional) copy running-config startup-config Example: switch(config)# copy running-config startup-config	Copies the running configuration to the startup configuration.

5.16.6 Configuring Syslog Servers on a UNIX or Linux System

You can configure a syslog server on a UNIX or Linux system by adding the following line to the `/etc/syslog.conf` file:

```
facility.level <five tab characters> action
```

The following table describes the syslog fields that you can configure.

Table 12 Syslog fields in `syslog.conf`

Field	Description
Facility	Creator of the message, which can be <code>auth</code> , <code>authpriv</code> , <code>cron</code> , <code>daemon</code> , <code>kern</code> , <code>lpr</code> , <code>mail</code> , <code>mark</code> , <code>news</code> , <code>syslog</code> , <code>user</code> , <code>local0</code> through <code>local7</code> , or an asterisk (*) for all. These facility designators allow you to control the destination of messages based on their origin. Note Check your configuration before using a local facility.
Level	Minimum severity level at which messages are logged, which can be <code>debug</code> , <code>info</code> , <code>notice</code> , <code>warning</code> , <code>err</code> , <code>crit</code> , <code>alert</code> , <code>emerg</code> , or an asterisk (*) for all. You can use <code>none</code> to disable a facility.
Action	Destination for messages, which can be a filename, a hostname preceded by the at sign (@), a comma-separated list of users, or an asterisk (*) for all logged-in users.

Procedure

Step 1 Log debug messages with the `local7` facility in the file `/var/log/myfile.log` by adding the following line to the

`/etc/syslog.conf` file:

Example:

```
debug.local7 var/log/myfile.log
```

Step 2 Create the log file by entering these commands at the shell prompt:

Example:

```
$ touch /var/log/myfile.log
$ chmod 666 /var/log/myfile.log
```

Step 3 Make sure the system message logging daemon reads the new changes by checking `myfile.log` after entering this command:

Example:

```
$ kill -HUP ~cat /etc/syslog.pid~
```

5.16.7 Displaying and Clearing Log Files

You can display or clear messages in the log file and the NVRAM.

Procedure

	Command or Action	Purpose
Step 1	Required: show logging last <i>number-lines</i> Example: switch# show logging last 40	Displays the last number of lines in the logging file. You can specify from 1 to 9999 for the last number of lines.
Step 2	show logging logfile [start-time <i>yyyy mmm dd hh:mm:ss</i>] [end-time <i>yyyy mmm dd hh:mm:ss</i>] Example: switch# show logging logfile start-time 2013 oct 1 15:10:0	Displays the messages in the log file that have a timestamp within the span entered. If you do not enter an end time, the current time is used. You enter three characters for the month time field and digits for the year and day time fields.
Step 3	show logging nvram [last <i>number-lines</i>] Example: switch# show logging nvram last 10	Displays the messages in the NVRAM. To limit the number of lines displayed, you can enter the last number of lines to display. You can specify from 1 to 100 for the last number of lines.
Step 4	clear logging logfile Example: switch# clear logging logfile	Clears the contents of the log file.
Step 5	clear logging nvram Example: switch# clear logging nvram	Clears the logged messages in NVRAM.

5.17 Verifying the System Message Logging Configuration

To display system message logging configuration information, perform one of the following tasks:

Command	Purpose
show logging console	Displays the console logging configuration.
show logging info	Displays the logging configuration.
show logging last <i>number-lines</i>	Displays the last number of lines of the log file.
show logging level [<i>facility</i>]	Displays the facility logging severity level configuration.
show logging logfile [start-time <i>yyyy mmm dd hh:mm:ss</i>] [end-time <i>yyyy mmm dd hh:mm:ss</i>]	Displays the messages in the log file.
show logging module	Displays the module logging configuration.
show logging monitor	Displays the monitor logging configuration.
show logging nvram [last <i>number-lines</i>]	Displays the messages in the NVRAM log.
show logging server	Displays the syslog server configuration.
show logging timestamp	Displays the logging time-stamp units configuration.

5.18 Configuration Example for System Message Logging

This example shows how to configure system message logging:

```
configure terminal
logging console 3
logging monitor 3
logging logfile my_log 6
```

```

logging module 3
logging level aaa 2
logging timestamp milliseconds
logging server 172.28.254.253
logging server 172.28.254.254 5 facility local3
copy running-config startup-config

```

5.19 Additional References

5.19.1 Related Documents

Related Topic	Document Title
System messages CLI commands	<i>Inspur CN12700 Series INOS System Management Command Reference</i>
System messages	<i>Inspur INOS System Messages Reference</i>

5.20 Feature History for System Message Logging

The table below summarizes the new and changed features for this document and shows the releases in which each feature is supported. Your software release might not support all the features in this document. For the latest caveats and feature information, the release notes for your software release.

Table 13 Feature History for System Message Logging

Feature Name	Releases	Feature Information
System message logging	7.2(0)D1(1)	This feature was introduced.
System message logging	5.2(1)	Added the ability to add the description for physical Ethernet interfaces and subinterfaces in the system message log.
Syslog servers	5.1(1)	Increased the number of supported syslog servers from three to eight.
IPv6 support	4.2(1)	Added support for IPv6 syslog hosts..
System message logging	4.0(1)	This feature was introduced.

CHAPTER 6 Configuring Smart Call Home

This chapter describes how to configure the Smart Call Home feature of the Inspur INOS devices. This chapter contains the following sections:

- Finding Feature Information
- About Smart Call Home
- Licensing Requirements for Smart Call Home
- Prerequisites for Smart Call Home
- Guidelines and Limitations for Smart Call Home
- Default Settings for Smart Call Home
- Configuring Smart Call Home
- Verifying the Smart Call Home Configuration
- Configuration Examples for Smart Call Home
- Additional References
- Feature History for Smart Call Home

6.1 Finding Feature Information

Your software release might not support all the features documented in this module. For the latest caveats and feature information, the release notes for your software release. To find information about the features documented in this module, and to see a list of the releases in which each feature is supported, see the "New and Changed Information" chapter or the Feature History table in this chapter.

6.2 About Smart Call Home

Smart Call Home provides an email-based notification for critical system policies. A range of message formats are available for compatibility with pager services, standard email, or XML-based automated parsing applications. You can use this feature to page a network support engineer, email a Network Operations Center, or use Inspur Smart Call Home services to automatically generate a case with the Technical Assistance Center.

Smart Call Home offers the following features:

- Automatic execution and attachment of relevant CLI command output.
- Multiple message format options such as the following:
 - Short Text—Suitable for pagers or printed reports.
 - Full Text—Fully formatted message information suitable for human reading.
 - XML—Machine-readable format that uses Extensible Markup Language (XML) and Adaptive Messaging Language (AML) XML schema definition (XSD). The AML XSD is published on the Inspur.com website. The XML format enables communication with the Technical Assistance Center.
- Multiple concurrent message destinations. You can configure up to 50 email destination addresses for each destination profile.

6.2.1 Destination Profiles

A destination profile includes the following information:

- One or more alert groups—The group of alerts that trigger a specific Smart Call Home message if the alert occurs.
- One or more email destinations—The list of recipients for the Smart Call Home messages generated by alert groups assigned to this destination profile.

- Message format—The format for the Smart Call Home message (short text, full text, or XML).
- Message severity level—The Smart Call Home severity level that the alert must meet before Inspur INOS generates a Smart Call Home message to all email addresses in the destination profile. Inspur INOS does not generate an alert if the Smart Call Home severity level of the alert is lower than the message severity level set for the destination profile.

You can also configure a destination profile to allow periodic inventory update messages by using the inventory alert group that will send out periodic messages daily, weekly, or monthly.

Inspur INOS supports the following predefined destination profiles:

- InspurTAC-1—Supports the Inspur-TAC alert group in XML message format. This profile is preconfigured with the `callhome@Inspur.com` email contact, maximum message size, and message severity level 0. You cannot change any of the default information for this profile.
 - full-text-destination—Supports the full text message format.
 - short-text-destination—Supports the short text message format.

6.2.2 Smart Call Home Alert Groups

An alert group is a predefined subset of Smart Call Home alerts that are supported in all Inspur CN devices. Alert groups allow you to select the set of Smart Call Home alerts that you want to send to a predefined or custom destination profile. The device sends Smart Call Home alerts to email destinations in a destination profile only if that Smart Call Home alert belongs to one of the alert groups associated with that destination profile and if the alert has a Smart Call Home message severity at or above the message severity set in the destination profile.

The following table lists the supported alert groups and the default CLI command output included in Smart Call Home messages generated for the alert group.

Alert Group	Description	Executed Commands
Inspur-TAC	All critical alerts from the other alert groups destined for Smart Call Home.	Execute commands based on the alert group that originates the alert.
Configuration	Periodic events related to configuration.	show module show version
Diagnostic	Events generated by diagnostics.	show diagnostic result module all detail show diagnostic result module <i>number</i> detail show hardware show logging last 200 show module show sprom all show tech-support gold show tech-support ha show tech-support platform show version
EEM	Events generated by EEM.	show diagnostic result module all detail show diagnostic result module <i>number</i> detail show module show tech-support gold show tech-support ha show tech-support platform
Environmental	Events related to power, fan, and environment-sensing elements such as temperature alarms.	show environment show logging last 200 show module show version
Inventory	Inventory status that is provided whenever a unit is	show inventory show license usage

Alert Group	Description	Executed Commands
License	cold booted or when FRUs are inserted or removed. This alert is considered a noncritical event, and the information is used for status and entitlement. Events related to licensing and license violations.	show module show sprom all show system uptime show version show logging last 200
Linecard hardware	Events related to standard or intelligent switching modules.	show diagnostic result module all detail show diagnostic result module number detail show hardware show logging last 200 show module show sprom all show tech-support ethpm show tech-support gold show tech-support ha show tech-support platform show version
Supervisor hardware	Events related to supervisor modules.	show diagnostic result module all detail show hardware show logging last 200 show module show sprom all show tech-support ethpm show tech-support gold show tech-support ha show tech-support platform show version
Syslog port group	Events generated by the syslog PORT facility.	show license usage show logging last 200
System	Events generated by failure of a software system that is critical to unit operation.	show diagnostic result module all detail show hardware show logging last 200 show module show sprom all show tech-support ethpm show tech-support gold show tech-support ha show tech-support platform
Test	User-generated test message.	show module show version

Smart Call Home maps the syslog severity level to the corresponding Smart Call Home severity level for syslog port group messages.

You can customize predefined alert groups to execute additional CLI show commands when specific events occur and send that show output with the Smart Call Home message.

You can add show commands only to full text and XML destination profiles. Short text destination profiles do not support additional show commands because they only allow 128 bytes of text.

6.2.3 Smart Call Home Message Levels

Smart Call Home allows you to filter messages based on their level of urgency. You can associate each predefined or user-defined destination profile with a Smart Call Home threshold from 0 (least urgent) to 9 (most urgent). The default is 0 (all messages are sent).

Syslog severity levels are mapped to the Smart Call Home message level.

The following table lists each Smart Call Home message level keyword and the corresponding syslog level for the syslog port alert group.

Table 14 Severity and Syslog Level Mapping

Smart Call Home Level	Keyword	Syslog Level	Description
9	Catastrophic	N/A	Network-wide catastrophic failure.
8	Disaster	N/A	Significant network impact.
7	Fatal	Emergency (0)	System is unusable.
6	Critical	Alert (1)	Critical conditions that indicate that immediate attention is needed.
5	Major	Critical (2)	Major conditions.
4	Minor	Error (3)	Minor conditions.
3	Warning	Warning (4)	Warning conditions.
2	Notification	Notice (5)	Basic notification and informational messages. Possibly independently insignificant.
1	Normal	Information (6)	Normal event signifying return to normal state.
0	Debugging	Debug (7)	Debugging messages.

6.2.4 Obtaining Smart Call Home

If you have a service contract directly with Inspur, you can register for the Smart Call Home service. Smart Call Home analyzes Smart Call Home messages and provides background information and recommendations. For known issues, particularly online diagnostics failures, Automatic Service Requests are generated with the Inspur TAC.

Smart Call Home offers the following features:

- Continuous device health monitoring and real-time diagnostic alerts.
- Analysis of Smart Call Home messages and, if needed, Automatic Service Request generation, routed to the correct TAC team, including detailed diagnostic information to speed problem resolution.
- Secure message transport directly from your device, through an HTTP proxy server, or a downloadable Transport Gateway (TG). You can use a TG aggregation point to support multiple devices or in cases where security dictates that your devices may not be connected directly to the Internet.
- Web-based access to Smart Call Home messages and recommendations, inventory, and configuration information for all Smart Call Home devices. This feature provides access to associated field notices, security advisories, and end-of-life information.

You need the following information to register:

- The SMARTnet contract number for your device
- Your email address
- Your Inspur.com ID

6.2.5 Distributing Smart Call Home Using CFS

You can use Inspur Fabric Services (CFS) to distribute a Smart Call Home configuration to all CFS-enabled devices in the network. The entire Smart Call Home configuration is distributed except the device priority and the sysContact names.

For more information about CFS, see the “Configuring CFS” section.

6.2.6 Database Merge Guidelines

When you merge two Smart Call Home databases, the following guidelines apply:

- The merged database contains the following information:
- A superset of all the destination profiles from the merging devices.
- The destination profile email addresses and alert groups.
- Other configuration information (for example, message throttling, or periodic inventory) present in the managing device.
- Destination profile names cannot be duplicated within the merging devices—even though the configurations are different, the names cannot be duplicated. If a profile name is duplicated, one of the duplicate profiles must first be deleted or the merger fails.

6.2.7 High Availability

Both stateful and stateless restarts are supported for Smart Call Home.

6.2.8 Virtualization Support

One instance of Smart Call Home is supported per virtual device context (VDC). Smart Call Home uses the contact information from the first registered VDC as the administrator contact for all VDCs on the physical device. For example, if you want the Smart Call Home to use the contact information from the default VDC, you should register using that VDC.

Smart Call Home registers the contacts for all other VDCs as users that can see all the Smart Call Home data for the physical device but cannot act as administrators. All registered users and the registered administrator receive all Smart Call Home notifications from all VDCs on the physical device.

By default, you are placed in the default VDC. In the default VDC, you can test Smart Call Home using the callhome send and callhome test commands. In a nondefault VDC, only the callhome test command is available. For more information on VDCs, see the Inspur CN12700 Series INOS Virtual Device Context Configuration Guide.

Smart Call Home is virtual routing and forwarding (VRF) aware. You can configure Smart Call Home to use a particular VRF to reach the Smart Call Home SMTP server.

6.3 Licensing Requirements for Smart Call Home

Product	License Requirement
Inspur INOS	Smart Call Home requires no license. Any feature not included in a license package is bundled with the INOS image and is provided at no extra charge to you. For a complete explanation of the Inspur INOS licensing scheme, see the <i>Inspur INOS Licensing Guide</i> .

6.4 Prerequisites for Smart Call Home

Smart Call Home has the following prerequisites:

- To send messages to an email address, you must first configure an email server. To send messages using HTTP, you must have access to an HTTPS server and have a valid certificate installed on the Inspur CN device.
- Your device must have IP connectivity to an email server or HTTPS server.
- You must first configure the contact name (SNMP server contact), phone, and street address information.

This step is required to determine the origin of messages received.

- If you use Smart Call Home, you need an active service contract for the device that you are configuring.
- If you configure VDCs, install the appropriate license. See the *Inspur CN12700 Series INOS Virtual Device Context Configuration Guide* for configuration information and the *Inspur INOS Licensing Guide* for licensing information.

6.5 Guidelines and Limitations for Smart Call Home

Smart Call Home has the following configuration guidelines and limitations:

- If there is no IP connectivity or if the interface in the virtual routing and forwarding (VRF) instance to the profile destination is down, the device cannot send Smart Call Home messages.
- Smart Call Home operates with any SMTP server.
- You can configure up to five SMTP servers for Smart Call Home.
- If you distribute the Smart Call Home configuration using CFS, then the entire Smart Call Home configuration is distributed except device priority and the sysContact names.
- Currently CoPP does not protect packets for Smart Call Home using HTTP/HTTPS or SMTP method when connectivity is required inband. Return traffic for these services is subject to class-default CoPP class and leads to little to no connectivity.
- A system configured for Smart Call Home (SCH) feature where connectivity may fail during reporting if an explicit class for either the HTTPS method or the SMTP method is not defined in control-plane policing and there is continual violations in the CoPP class-default class. This issue is only seen when the configured destination from SCH is known inband.
- A syslog should be printed if inband is used for SCH where non-standard destination ports are used warning the user to add these ports. Consideration should also be made with a syslog warning when using either a HTTP or HTTPS proxy server on a non-administrative port to allow reachability to Inspur's web servers.
- In a mixed fabric environment with CFS enabled, Inspur devices running Inspur INOS Release 5.x can distribute 5.x configurations (multiple SMTP server support, HTTP VRF support, and HTTP proxy support) to other 5.x devices in the fabric over CFS. However, if an existing device upgrades to 5.x, these new configurations are not distributed to that device because a CFS merge is not triggered upon an upgrade. Therefore, we recommend applying the new configurations only when all the devices in the fabric support them or performing an empty commit from an existing 5.x device (not the newly upgraded device) that has the new configurations.

6.6 Default Settings for Smart Call Home

This table lists the default settings for Smart Call Home parameters.

Table 15 Default Smart Call Home Parameters

Parameters	Default
Destination message size for a message sent in full text format	2,500,000
Destination message size for a message sent in XML format	2,500,000
Destination message size for a message sent in short text format	4000
SMTP server port number if no port is specified	25
SMTP server priority if no priority is specified	50
Alert group association with profile	All for full-text-destination and short-text-destination profiles. The Inspur-tac alert group for the InspurTAC-1 destination profile.
Format type	XML
Smart Call Home message level	0 (zero)
HTTP proxy server use	Disabled and no proxy server configured

6.7 Configuring Smart Call Home

We recommend that you complete the Smart Call Home configuration procedures in the following sequence:

1. Configuring Contact Information

2. Creating a Destination Profile
3. Associating an Alert Group with a Destination Profile
4. (Optional) Adding Show Commands to an Alert Group
5. Enabling or Disabling Smart Call Home
6. (Optional) Testing the Smart Call Home Configuration

6.7.1 Configuring Contact Information

You must configure the email, phone, and street address information for Smart Call Home. You can optionally configure the contract ID, customer ID, site ID, and switch priority information.

Procedure

	Command or Action	Purpose
Step 1	configure terminal Example: switch# configure terminal switch(config)#	Enters global configuration mode.
Step 2	snmp-server contact <i>sys-contact</i> Example: switch(config)# snmp-server contact personname@companyname.com	Configures the SNMP sysContact.
Step 3	callhome Example: switch(config)# callhome switch(config-callhome)#	Enters Smart Call Home configuration mode.
Step 4	email-contact <i>email-address</i> Example: switch(config-callhome)# email-contact admin@Mycompany.com	Configures the email address for the person primarily responsible for the device. The <i>email-address</i> can be up to 255 alphanumeric characters in email address format. Note You can use any valid email address. The address cannot contain spaces.
Step 5	phone-contact <i>international-phone-number</i> Example: switch(config-callhome)# phone-contact +1-800-123-4567	Configures the phone number in international phone number format for the person primarily responsible for the device. The <i>international-phone-number</i> can be up to 17 alphanumeric characters and must be in international phone number format. Note The phone number cannot contain spaces. Use the plus (+) prefix before the number.
Step 6	streetaddress <i>address</i> Example: switch(config-callhome)# streetaddress 123 Anystreet st. Anytown,AnyWhere	Configures the street address as an alphanumeric string with white spaces for the person primarily responsible for the device. The <i>address</i> can be up to 255 alphanumeric characters. Spaces are accepted.
Step 7	(Optional) contract-id <i>contract-number</i> Example: switch(config-callhome)# contract-id Contract5678	Configures the contract number for this device from the service agreement. The <i>contract-number</i> can be up to 255 alphanumeric characters in free format.
Step 8	(Optional) customer-id <i>customer-number</i>	Configures the customer number for this device

	Command or Action	Purpose
	Example: switch(config-callhome)# customer-id Customer123456	from the service agreement. The <i>customer-number</i> can be up to 255 alphanumeric characters in free format.
Step 9	(Optional) site-id <i>site-number</i> Example: switch(config-callhome)# site-id Site1	Configures the site number for this device. The <i>site-number</i> can be up to 255 alphanumeric characters in free format.
Step 10	(Optional) switch-priority <i>number</i> Example: switch(config-callhome)# switch-priority 3	Configures the switch priority for this device. The range is from 0 to 7, with 0 being the highest priority and 7 the lowest. The default is 7. Note Switch priority is used by the operations personnel or TAC support personnel to decide which Call Home message should be responded to first. You can prioritize Call Home alerts of the same severity from each switch.
Step 11	commit Example: switch(config-callhome)# commit	Commits the Smart Call Home configuration commands.
Step 12	(Optional) show callhome Example: switch(config-callhome)# show callhome	Displays a summary of the Smart Call Home configuration.
Step 13	(Optional) copy running-config startup-config Example: switch(config)# copy running-config startup-config	Copies the running configuration to the startup configuration.

What to do next

Create a destination profile.

6.7.2 Creating a Destination Profile

You can create a user-defined destination profile and configure its message format.

Procedure

	Command or Action	Purpose
Step 1	configure terminal Example: switch# configure terminal switch(config)#	Enters global configuration mode.
Step 2	callhome Example: switch(config)# callhome switch(config-callhome)#	Enters Smart Call Home configuration mode.
Step 3	destination-profile <i>name</i> Example: switch(config-callhome)# destination-profile Noc101	Creates a new destination profile. The name can be any alphanumeric string up to 31 characters.
Step 4	destination-profile <i>name</i> format {XML full-txt short-txt}	Sets the message format for the profile. The name can be any alphanumeric string up to 31

	Command or Action	Purpose
	Example: switch(config-callhome)# destination-profile Noc101 format full-txt	characters.
Step 5	commit Example: switch(config-callhome)# commit	Commits the Smart Call Home configuration commands.
Step 6	(Optional) show callhome destination-profile [profile name] Example: switch(config-callhome)# show callhome destination-profile profile Noc101	Displays information about one or more destination profiles.
Step 7	(Optional) copy running-config startup-config Example: switch(config)# copy running-config startup- config	Copies the running configuration to the startup configuration.

What to do next

Associate one or more alert groups with a destination profile.

6.7.3 Modifying a Destination Profile

You can modify the following attributes for a predefined or user-defined destination profile:

- Destination email address—The actual address, pertinent to the transport mechanism, to which the alert should be sent.
- Destination URL—The HTTP or HTTPS URL that defines where alerts should be sent.
- Transport method—The email or HTTP transport that determines which type of destination addresses are used.
- Message formatting—The message format used for sending the alert (full text, short text, or XML).
- Message level—The Smart Call Home message severity level for this destination profile.
- Message size—The allowed length of a Smart Call Home message sent to the email addresses in this destination profile.

Procedure

	Command or Action	Purpose
Step 1	configure terminal Example: switch# configure terminal switch(config)#	Enters global configuration mode.
Step 2	callhome Example: switch(config)# callhome switch(config- callhome)#	Enters Smart Call Home configuration mode.
Step 3	destination-profile { <i>name</i> InspurTAC-1 full- txt-destination short-txt-destination } email- addr <i>address</i> Example: switch(config-callhome)# destination-profile full-txt-destination email-addr person@place.com	Configures an email address for a user-defined or predefined destination profile. You can configure up to 50 email addresses in a destination profile.

	Command or Action	Purpose
Step 4	destination-profile <i>{name InspurTAC-1 full-txt-destination short-txt-destination}</i> http <i>address</i> Example: switch(config-callhome)# destination-profile InspurTAC-1 http http://site.com/service/callhome	Configures an HTTP or HTTPS URL for a user-defined or predefined destination profile. The URL can be up to 255 characters.
Step 5	destination-profile <i>{name InspurTAC-1 full-txt-destination short-txt-destination}</i> transport-method <i>{email http}</i> Example: switch(config-callhome)# destination-profile InspurTAC-1 transport-method http	Configures an email or HTTP transport method for a user-defined or predefined destination profile. The type of transport method that you choose determines the configured destination addresses of that type.
Step 6	destination-profile <i>{name InspurTAC-1 full-txt-destination short-txt-destination}</i> message-level <i>number</i> Example: switch(config-callhome)# destination-profile full-txt-destination message-level 5	Configures the Smart Call Home message severity level for this destination profile. Inspur INOS sends only alerts that have a matching or higher Smart Call Home severity level to destinations in this profile. The range is from 0 to 9, where 9 is the highest severity level.
Step 7	destination-profile <i>{name InspurTAC-1 full-txt-destination short-txt-destination}</i> message-size <i>number</i> Example: switch(config-callhome)# destination-profile full-txt-destination message-size 100000	Configures the maximum message size for this destination profile. The range is from 0 to 5000000. The default is 2500000.
Step 8	commit Example: switch(config-callhome)# commit	Commits the Smart Call Home configuration commands.
Step 9	(Optional) show callhome destination-profile <i>[profile name]</i> Example: switch(config-callhome)# show callhome destination-profile profile full-text-destination	Displays information about one or more destination profiles.
Step 10	(Optional) copy running-config startup-config Example: switch(config)# copy running-config startup-config	Copies the running configuration to the startup configuration.

What to do next

Associate one or more alert groups with a destination profile.

6.7.4 Associating an Alert Group with a Destination Profile

Procedure

	Command or Action	Purpose
Step 1	configure terminal Example: switch# configure terminal switch(config)#	Enters global configuration mode.
Step 2	callhome Example: switch(config)# callhome switch(config-callhome)#	Enters Smart Call Home configuration mode.
Step 3	destination-profile { <i>name</i> InspurTAC-1 full-txt-destination short-txt-destination } alert-group { All Inspur-TAC Configuration Diagnostic EEM Environmental Inventory License Supervisor-Hardware Syslog-group-port System Test } Example: switch(config-callhome)# destination-profile Noc101 alert-group All	Associates an alert group with this destination profile. Use the All keyword to associate all alert groups with the destination profile.
Step 4	commit Example: switch(config-callhome)# commit	Commits the Smart Call Home configuration commands.
Step 5	(Optional) show callhome destination-profile [profile name] Example: switch(config-callhome)# show callhome destination-profile profile Noc101	Displays information about one or more destination profiles.
Step 6	(Optional) copy running-config startup-config Example: switch(config)# copy running-config startup-config	Copies the running configuration to the startup configuration.

What to do next

Optionally add show commands to an alert group and then configure the SMTP email server.

6.7.5 Adding Show Commands to an Alert Group

You can assign a maximum of five user-defined CLI show commands to an alert group.

Procedure

	Command or Action	Purpose
Step 1	configure terminal Example: switch# configure terminal switch(config)#	Enters global configuration mode.
Step 2	callhome Example: switch(config)# callhome switch(config-callhome)#	Enters Smart Call Home configuration mode.

	Command or Action	Purpose
Step 3	alert-group { Configuration Diagnostic EEM Environmental Inventory License Supervisor-Hardware Syslog-group-port System Test } user-def-cmd <i>show-cmd</i> Example: switch(config-callhome)# alert-group Configuration user-def-cmd show ip route	Adds the show command output to any Smart Call Home messages sent for this alert group. Only valid show commands are accepted.
Step 4	commit Example: switch(config-callhome)# commit	Commits the Smart Call Home configuration commands.
Step 5	(Optional) show callhome user-def-cmds Example: switch(config-callhome)# show callhome user-def-cmds	Displays information about all user-defined show commands added to alert groups.
Step 6	(Optional) copy running-config startup-config Example: switch(config)# copy running-config startup-config	Copies the running configuration to the startup configuration.

What to do next

Configure Smart Call Home to connect to the SMTP email server.

6.7.6 Configuring the Email Server

You must configure the SMTP server address for the Smart Call Home functionality to work. You can also configure the from and reply-to email addresses.

You can configure up to five SMTP servers for Smart Call Home. The servers are tried based on their priority. The highest priority server is tried first. If the message fails to be sent, the next server in the list is tried until the limit is exhausted. If two servers have equal priority, the one that was configured earlier is tried first.

Procedure

	Command or Action	Purpose
Step 1	configure terminal Example: switch# configure terminal switch(config)#	Enters global configuration mode.
Step 2	callhome Example: switch(config)# callhome switch(config-callhome)#	Enters Smart Call Home configuration mode.
Step 3	transport email mail-server <i>ip-address</i> [port number] [priority number] [use-vrf vrf-name] Example: switch(config-callhome)# transport email mail-server 192.0.2.1 use-vrf Red	Configures the SMTP server as the domain name server (DNS) name, IPv4 address, or IPv6 address. Optionally configures the port number. The port range is from 1 to 65535. The default port number is 25. Also optionally configures the priority of the SMTP server. The priority range is from 1 to 100, with 1 being the highest priority and 100 the

	Command or Action	Purpose
		lowest. If you do not specify a priority, the default value of 50 is used. Also optionally configures the VRF to use when communicating with this SMTP server. The VRF specified is not used to send messages using HTTP.
Step 4	(Optional) transport email from <i>email-address</i> Example: switch(config-callhome)# transport email from person@company.com	Configures the email from field for Smart Call Home messages.
Step 5	(Optional) transport email reply-to <i>email-address</i> Example: switch(config-callhome)# transport email reply-to person@company.com	Configures the email reply-to field for Smart Call Home messages.
Step 6	commit Example: switch(config-callhome)# commit	Commits the Smart Call Home configuration commands.
Step 7	(Optional) show callhome transport Example: switch(config-callhome)# show callhome transport	Displays the transport-related configuration for Smart Call Home.
Step 8	(Optional) copy running-config startup-config Example: switch(config)# copy running-config startup-config	Copies the running configuration to the startup configuration.

What to do next

Optionally use VRFs to send Smart Call Home messages over HTTP.

6.7.7 Configuring VRFs To Send Messages Using HTTP

You can use VRFs to send Smart Call Home messages over HTTP. If HTTP VRFs are not configured, the default VRF is used to transport messages over HTTP.

Procedure

	Command or Action	Purpose
Step 1	configure terminal Example: switch# configure terminal switch(config)#	Enters global configuration mode.
Step 2	callhome Example: switch(config)# callhome switch(config-callhome)#	Enters Smart Call Home configuration mode.
Step 3	transport http use-vrf <i>vrf-name</i> Example: switch(config-callhome)# transport http use-vrf	Configures the VRF used to send email and other Smart Call Home messages over HTTP.

	Command or Action	Purpose
	Blue	
Step 4	commit Example: switch(config-callhome)# commit	Commits the Smart Call Home configuration commands.
Step 5	(Optional) show callhome Example: switch(config-callhome)# show callhome	Displays information about Smart Call Home.
Step 6	(Optional) copy running-config startup-config Example: switch(config)# copy running-config startup-config	Copies the running configuration to the startup configuration.

What to do next

Optionally configure Smart Call Home to send HTTP messages through an HTTP proxy server.

6.7.8 Configuring an HTTP Proxy Server

Procedure

	Command or Action	Purpose
Step 1	configure terminal Example: switch# configure terminal switch(config)#	Enters global configuration mode.
Step 2	callhome Example: switch(config)# callhome switch(config-callhome)#	Enters Smart Call Home configuration mode.
Step 3	transport http proxy server ip-address [port number] Example: switch(config-callhome)# transport http proxy server 192.0.2.1	Configures the HTTP proxy server domain name server (DNS) name, IPv4 address, or IPv6 address. Optionally configures the port number. The port range is from 1 to 65535. The default port number is 8080.
Step 4	transport http proxy enable Example: switch(config-callhome)# transport http proxy enable	Enables Smart Call Home to send all HTTP messages through the HTTP proxy server. Note You can execute this command only after the proxy server address has been configured. Note The VRF used for transporting messages through the proxy server is the same as that configured using the transport http use-vrf command.
Step 5	commit Example: switch(config-callhome)# commit	Commits the Smart Call Home configuration commands.
Step 6	(Optional) show callhome transport Example: switch(config-callhome)# show callhome	Displays the transport-related configuration for Smart Call Home.

	Command or Action	Purpose
	transport	
Step 7	(Optional) copy running-config startup-config Example: switch(config)# copy running-config startup-config	Copies the running configuration to the startup configuration.

What to do next

Optionally configure your device to periodically send inventory notifications.

6.7.9 Configuring Periodic Inventory Notifications

You can configure the device to periodically send a message with an inventory of all software services currently enabled and running on the device along with hardware inventory information. The device generates two Smart Call Home notifications: periodic configuration messages and periodic inventory messages.

Procedure

	Command or Action	Purpose
Step 1	configure terminal Example: switch# configure terminal switch(config)#	Enters global configuration mode.
Step 2	callhome Example: switch(config)# callhome switch(config-callhome)#	Enters Smart Call Home configuration mode.
Step 3	periodic-inventory notification [<i>interval days</i>] [<i>timeofday time</i>] Example: switch(config-callhome)# periodic-inventory notification interval 20	Configures periodic inventory messages. The interval range is from 1 to 30 days, and the default is 7 days. The <i>time</i> argument is in HH:MM format. It defines at what time of the day every <i>X</i> days an update is sent (where <i>X</i> is the update interval).
Step 4	commit Example: switch(config-callhome)# commit	Commits the Smart Call Home configuration commands.
Step 5	(Optional) show callhome Example: switch(config-callhome)# show callhome	Displays information about Smart Call Home.
Step 6	(Optional) copy running-config startup-config Example: switch(config)# copy running-config startup-config	Copies the running configuration to the startup configuration.

What to do next

Optionally disable duplicate message throttling.

6.7.10 Disabling Duplicate Message Throttling

You can limit the number of duplicate messages received for the same event. By default, the device limits the number of duplicate messages received for the same event. If the number of duplicate messages sent exceeds 30 messages within a 2-hour time frame, the device discards further messages for that alert type.

Procedure

	Command or Action	Purpose
Step 1	configure terminal Example: switch# configure terminal switch(config)#	Enters global configuration mode.
Step 2	callhome Example: switch(config)# callhome switch(config-callhome)#	Enters Smart Call Home configuration mode.
Step 3	no duplicate-message throttle Example: switch(config-callhome)# no duplicate-message throttle	Disables duplicate message throttling for Smart Call Home. Duplicate message throttling is enabled by default.
Step 4	commit Example: switch(config-callhome)# commit	Commits the Smart Call Home configuration commands.
Step 5	(Optional) copy running-config startup-config Example: switch(config)# copy running-config startup-config	Copies the running configuration to the startup configuration.

What to do next

Enable Smart Call Home.

6.7.11 Enabling or Disabling Smart Call Home

Once you have configured the contact information, you can enable the Smart Call Home function.

Procedure

	Command or Action	Purpose
Step 1	configure terminal Example: switch# configure terminal switch(config)#	Enters global configuration mode.
Step 2	callhome Example: switch(config)# callhome switch(config-callhome)#	Enters Smart Call Home configuration mode.
Step 3	[no] enable Example: switch(config-callhome)# enable	Enables or disables Smart Call Home. Smart Call Home is disabled by default.
Step 4	commit Example:	Commits the Smart Call Home configuration commands.

	Command or Action	Purpose
	switch(config-callhome)# commit	
Step 5	(Optional) copy running-config startup-config Example: switch(config)# copy running-config startup-config	Copies the running configuration to the startup configuration.

What to do next

Optionally generate a test message.

6.7.12 Testing the Smart Call Home Configuration

You can generate a test message to test your Smart Call Home communications.

Procedure

	Command or Action	Purpose
Step 1	configure terminal Example: switch# configure terminal switch(config)#	Enters global configuration mode.
Step 2	callhome Example: switch(config)# callhome switch(config-callhome)#	Enters Smart Call Home configuration mode.
Step 3	callhome send [configuration diagnostic] Example: switch(config-callhome)# callhome send diagnostic	Sends the specified Smart Call Home test message to all configured destinations.
Step 4	callhome test Example: switch(config-callhome)# callhome test	Sends a test message to all configured destinations.
Step 5	(Optional) copy running-config startup-config Example: switch(config)# copy running-config startup-config	Copies the running configuration to the startup configuration.

6.8 Verifying the Smart Call Home Configuration

To display Smart Call Home configuration information, perform one of the following tasks:

Command	Purpose
show callhome	Displays the Smart Call Home configuration.
show callhome destination-profile <i>name</i>	Displays one or more Smart Call Home destination profiles.
show callhome merge	Displays the status of the last CFS merger for Smart Call Home.
show callhome pending	Displays the Smart Call Home configuration changes in the pending CFS database.
show callhome pending-diff	Displays the differences between the pending and running Smart Call Home configuration.

show callhome session-status	Displays the status of the last CFS commit or abort operation.
show callhomestatus	Displays the CFS distribution state (enabled or disabled) for Smart Call Home.
show callhome transport	Displays the transport-related configuration for Smart Call Home.
show callhome user-def-cmds	Displays CLI commands added to any alert groups.
show running-config callhome [all]	Displays the running configuration for Smart Call Home.
show startup-config callhome	Displays the startup configuration for Smart Call Home.
show tech-support callhome	Displays the technical support output for Smart Call Home.

6.9 Configuration Examples for Smart Call Home

This example shows how to create a destination profile called Noc101, associate the Configuration alert group to that profile, configure contact and email information, and specify the VRF used to send Smart Call Home messages over HTTP:

```
configure terminal
snmp-server contact person@company.com
callhome
distribute
email-contact admin@Mycompany.com
phone-contact +1-800-123-4567

streetaddress 123 Anystreet st. Anytown,AnyWhere

destination-profile Noc101 format full-txt
destination-profile full-text-destination email-addr person@company.com
destination-profile full-text-destination message-level 5
destination-profile Noc101 alert-group Configuration
alert-group Configuration user-def-cmd show ip route
transport email mail-server 192.0.2.10 priority 1
transport http use-vrf Blue
enable
commit
```

This example shows how to configure multiple SMTP servers for Smart Call Home messages:

```
configure terminal

callhome
transport email mail-server 192.0.2.10 priority 4
transport email mail-server 172.21.34.193 transport
email smtp-server 10.1.1.174
transport email mail-server 64.72.101.213 priority 60
transport email from person@company.com
transport email reply-to person@company.com
commit
```

Based on the configuration above, the SMTP servers would be tried in this order:

```
10.1.1.174 (priority 0)
192.0.2.10 (priority 4)
172.21.34.193 (priority 50, which is the default)
64.72.101.213 (priority 60)
```

This example shows how to configure Smart Call Home to send HTTP messages through an HTTP proxy server:

```
configure terminal
```



```

callhome
transport http proxy server 10.10.10.1 port 4
transport http proxy enable
commit

```

6.10 Additional References

6.10.1 Event Triggers

The following table lists the event triggers and their Smart Call Home message severity levels.

Alert Group	Event Name	Description	Smart Call Home Severity Level
Configuration	PERIODIC_CONFIGURATION	Periodic configuration update message.	2
Diagnostic	DIAGNOSTIC_MAJOR_ALERT	GOLD generated a major alert.	7
	DIAGNOSTIC_MINOR_ALERT	GOLD generated a minor alert.	4
	DIAGNOSTIC_NORMAL_ALERT	Smart Call Home generated a normal diagnostic alert.	2
Environmental and INSPUR_TAC	FAN_FAILURE	Cooling fan has failed.	5
	POWER_SUPPLY_ALERT	Power supply warning has occurred.	6
	POWER_SUPPLY_FAILURE	Power supply has failed.	6
	POWER_SUPPLY_SHUTDOWN	Power supply has shut down.	6
	TEMPERATURE_ALARM	Thermal sensor going bad.	6
	TEMPERATURE_MAJOR_ALARM	Thermal sensor indicates temperature has reached operating major threshold.	6
Inventory and INSPUR_TAC	TEMPERATURE_MINOR_ALARM	Thermal sensor indicates temperature has reached operating minor threshold.	4
	COLD_BOOT	Switch is powered up and reset to a cold boot sequence.	2
	HARDWARE_INSERTION	New piece of hardware has been inserted into the chassis.	2
	HARDWARE_REMOVAL	Hardware has been removed from the chassis.	2
License	PERIODIC_INVENTORY	Periodic inventory message has been generated.	2
	LICENSE_VIOLATION	Feature in use is not licensed and is turned off after grace period expiration.	6
Line module Hardware and INSPUR_TAC	LINEmodule_FAILURE	Module operation has failed.	7
Supervisor Hardware and INSPUR_TAC	SUP_FAILURE	Supervisor module operation has failed.	7
Syslog-group-	PORT_FAILURE	syslog message that corresponds to	6

Alert Group	Event Name	Description	Smart Call Home Severity Level
port		the port facility has been generated.	
	SYSLOG_ALERT	syslog alert message has been generated.	5
System and INSPUR_TAC	SW_CRASH	Software process has failed with a stateless restart, indicating an interruption of a service. Messages are sent for process crashes on supervisor modules.	5
	SW_SYSTEM_INCONSISTENT	Inconsistency has been detected in software or file system.	5
Test and INSPUR_TAC	TEST	User generated test has occurred.	2

6.10.2 Message Formats

Smart Call Home supports the following message formats:

6.10.2.1 Short Text Message Format

The following table describes the short text formatting option for all message types.

Data Item	Description
Device identification	Configured device name
Date/time stamp	Time stamp of the triggering event
Error isolation message	Plain English description of triggering event
Alarm urgency level	Error level such as that applied to system message

6.10.2.2 Common Event Message Fields

The following table describes the first set of common event message fields for full text or XML messages.

Data Item (Plain Text and XML)	Description (Plain Text and XML)	XML Tag (XML Only)
Timestamp	Date and time stamp of event in ISO time notation: YYYY-MM-DD HH:MM:SS GMT+HH:MM.	/aml/header/time
Message name	Name of message.	/aml/header/name
Message type	Name of message type, such as reactive or proactive.	/aml/header/type
Message group	Name of alert group, such as syslog.	/aml/header/group
Severity level	Severity level of message.	/aml/header/level
Source ID	Product type for routing, such as the Catalyst 6500 series switch.	/aml/header/source
Device ID	Unique device identifier (UDI) for the end device that generated the message.	/aml/ header/deviceId

Data Item (Plain Text and XML)	Description (Plain Text and XML)	XML Tag (XML Only)
	<p>This field should be empty if the message is nonspecific to a device. The format is <i>type@Sid@serial</i>.</p> <ul style="list-style-type: none"> <i>type</i> is the product model number from the backplane IDPROM. @ is a separator character. <i>Sid</i> is C, identifying the serial ID as a chassis serial number. <i>serial</i> is the number identified by the Sid field. <p>An example is WS-C6509@C@12345678.</p>	
Customer ID	Optional user-configurable field used for contract information or other ID by any support service.	/aml/ header/customerID
Contract ID	Optional user-configurable field used for contract information or other ID by any support service.	/aml/ header /contractId
Site ID	Optional user-configurable field used for Inspur-supplied site ID or other data meaningful to alternate support service.	/aml/ header/siteId
Server ID	<p>If the message is generated from the device, this ID is the unique device identifier (UDI) of the device. The format is <i>type@Sid@serial</i>.</p> <ul style="list-style-type: none"> <i>type</i> is the product model number from the backplane IDPROM. @ is a separator character. <i>Sid</i> is C, identifying the serial ID as a chassis serial number. <i>serial</i> is the number identified by the Sid field. <p>An example is WS-C6509@C@12345678.</p>	/aml/header/serverId
Message description	Short text that describes the error.	/aml/body/msgDesc
Device name	Node that experienced the event (hostname of the device).	/aml/body/sysName
Contact name	Name of person to contact for issues associated with the node that experienced the event.	/aml/body/sysContact
Contact email	Email address of person identified as the contact for this unit.	/aml/body/sysContactEmail
Contact phone number	Phone number of the person identified as the contact for this unit.	/aml/body/sysContactPhone Number
Street address	Optional field that contains the street address for RMA part shipments associated with this unit.	/aml/body/sysStreetAddress

Data Item (Plain Text and XML)	Description (Plain Text and XML)	XML Tag (XML Only)
Model name	Model name of the device (the specific model as part of a product family name).	/aml/body/chassis/name
Serial number	Chassis serial number of the unit.	/aml/body/chassis/serialNo
Chassis part number	Top assembly number of the chassis.	/aml/body/chassis/partNo

6.10.2.3 Alert Group Message Fields

The following table describes the fields specific to alert group messages for full text and XML. These fields may be repeated if multiple CLI commands are executed for an alert group.

Data Item (Plain Text and XML)	Description (Plain Text and XML)	XML Tag (XML Only)
Command output name	Exact name of the issued CLI command.	/aml/attachments/attachment/name
Attachment type	Specific command output.	/aml/attachments/attachment/type
MIME type	Either plain text or encoding type.	/aml/attachments/attachment/mime
Command output text	Output of command automatically executed.	/aml/attachments/attachment/atdata

6.10.2.4 Fields for Reactive and Proactive Event Messages

The following table describes the reactive and proactive event message format for full text or XML messages.

Data Item (Plain Text and XML)	Description (Plain Text and XML)	XML Tag (XML Only)
Chassis hardware version	Hardware version of chassis.	/aml/body/chassis/hwVersion
Supervisor module software version	Top-level software version.	/aml/body/chassis/swVersion
Affected FRU name	Name of the affected FRU that is generating the event message.	/aml/body/fru/name
Affected FRU serial number	Serial number of the affected FRU.	/aml/body/fru/serialNo
Affected FRU part number	Part number of the affected FRU.	/aml/body/fru/partNo
FRU slot	Slot number of the FRU that is generating the event message.	/aml/body/fru/slot
FRU hardware version	Hardware version of the affected FRU.	/aml/body/fru/hwVersion
FRU software version	Software version(s) that is running on the affected FRU.	/aml/body/fru/swVersion

6.10.2.5 Fields for Inventory Event Messages

The following table describes the inventory event message format for full text or XML messages.

Data Item (Plain Text and XML)	Description (Plain Text and XML)	XML Tag (XML Only)
Chassis hardware version	Hardware version of the chassis.	/aml/body/chassis/hwVersion
Supervisor module software version	Top-level software version.	/aml/body/chassis/swVersion
FRU name	Name of the affected FRU that is generating the event message.	/aml/body/fru/name
FRU s/n	Serial number of the FRU.	/aml/body/fru/serialNo

FRU part number	Part number of the FRU.	/aml/body/fru/partNo
FRU slot	Slot number of the FRU.	/aml/body/fru/slot
FRU hardware version	Hardware version of the FRU.	/aml/body/fru/hwVersion
FRU software version	Software version(s) that is running on the FRU.	/aml/body/fru/swVersion

6.10.2.6 Fields for User-Generated Test Messages

The following table describes the user-generated test message format for full text or XML.

Data Item (Plain Text and XML)	Description (Plain Text and XML)	XML Tag (XML Only)
Process ID	Unique process ID.	/aml/body/process/id
Process state	State of process (for example, running or halted).	/aml/body/process/processState
Process exception	Exception or reason code.	/aml/body/process/exception

6.10.3 Sample Syslog Alert Notification in Full-Text Format

This sample shows the full-text format for a syslog port alert-group notification:

```
Severity Level:5
Series:CN7000 Switch
Priority:0
Device Id:CN127-C7010@C@TXX12345678
Server Id:CN127-C7010@C@TXX12345678
Time of Event:2008-01-17 16:31:33 GMT+0000 Message Name:
Message Type:syslog
System Name:dc3-test
Contact Name:Jay Tester
Contact Email:contact@example.com
Contact Phone:+91-80-1234-5678
Street Address:#1 Any Street
Event Description:SYSLOG_ALERT 2008 Jan 17 16:31:33 dc3-test %ETHPORT-2-IF_SEQ_ERROR: Error
(0x20) while
communicating with component MTS_SAP_ELTM opcode:MTS_OPC_ETHPM_PORT_PHY_CLEANUP
(for:RID_PORT:
Ethernet3/1)

syslog_facility:ETHPORT start
chassis information: Affected
Chassis:CN127-C7010
Affected Chassis Serial Number:TXX12345678 Affected Chassis Hardware Version:0.405 Affected
Chassis Software
Version:4.1(1) Affected Chassis Part No:73-10900-04 end chassis information:
start attachment
name:show logging logfile | tail -n 200
type:text
data:
2008 Jan 17 10:57:51 dc3-test %SYSLOG-1-SYSTEM_MSG : Logging logfile (messages) cleared by
user
2008 Jan 17 10:57:53 dc3-test %VSHD-5-VSHD_SYSLOG_CONFIG_I: Configuring console from
/dev/ttyS0 /dev/ttyS0_console
2008 Jan 17 10:58:35 dc3-test %VSHD-5-VSHD_SYSLOG_CONFIG_I: Configuring console from
/dev/ttyS0 /dev/ttyS0_console
2008 Jan 17 10:59:00 dc3-test %DAEMON-3-SYSTEM_MSG: error: setsockopt IP_TOS 16: Invalid
argument: - sshd[14484]
```

```

2008 Jan 17 10:59:05 dc3-test %VSHD-5-VSHD_SYSLOG_CONFIG_I: Configuring console from
/dev/ttyS0 /dev/ttyS0_console
2008 Jan 17 12:11:18 dc3-test %SYSMGR-STANDBY-5-SUBPROC_TERMINATED: "System Manager (gsync
controller)" (PID 12000)
has finished with error code SYSMGR_EXITCODE_GSYNCFALIED_NONFATAL (12).
2008 Jan 17 16:28:03 dc3-test %VSHD-5-VSHD_SYSLOG_CONFIG_I: Configuring console from
/dev/ttyS0 /dev/ttyS0_console
2008 Jan 17 16:28:44 dc3-test %SYSMGR-3-BASIC_TRACE: core_copy: PID 2579 with message Core
not generated by system
for eltm(0). WCOREDUMP(9) returned zero .
2008 Jan 17 16:28:44 dc3-test %SYSMGR-2-SERVICE_CRASHED: Service "eltm" (PID 3504) hasn't
caught signal 9 (no core).
2008 Jan 17 16:29:08 dc3-test %SYSMGR-3-BASIC_TRACE: core_copy: PID 2579 with message Core
not generated by system
for eltm(0). WCOREDUMP(9) returned zero.
2008 Jan 17 16:29:08 dc3-test %SYSMGR-2-SERVICE_CRASHED: Service "eltm" (PID 23210) hasn't
caught signal 9 (no core).
2008 Jan 17 16:29:17 dc3-test %SYSMGR-3-BASIC_TRACE: core_copy: PID 2579 with message Core
not generated by system
for eltm(0). WCOREDUMP(9) returned zero.
2008 Jan 17 16:29:17 dc3-test %SYSMGR-2-SERVICE_CRASHED: Service "eltm" (PID 23294) hasn't
caught signal 9 (no core).
2008 Jan 17 16:29:25 dc3-test %SYSMGR-2-HASWITCHOVER_PRE_START: This supervisor is
becoming active (pre-start phase).
2008 Jan 17 16:29:25 dc3-test %SYSMGR-2-HASWITCHOVER_START: This supervisor is becoming
active.
2008 Jan 17 16:29:26 dc3-test %USER-3-SYSTEM_MSG: crdcfg_get_srvinfo: mts_send failed -
device_test
2008 Jan 17 16:29:27 dc3-test %NETSTACK-3-IP_UNK_MSG_MAJOR: netstack [4336] Unrecognized
message from MRIB. Major
type 1807
2008 Jan 17 16:29:27 dc3-test %IM-5-IM_INTF_STATE: mgmt0 is DOWN in vdc 1
2008 Jan 17 16:29:27 dc3-test %IM-5-IM_INTF_STATE: mgmt0 is DOWN in vdc 2
2008 Jan 17 16:29:27 dc3-test %IM-5-IM_INTF_STATE: mgmt0 is DOWN in vdc 3
2008 Jan 17 16:29:27 dc3-test %IM-5-IM_INTF_STATE: mgmt0 is DOWN in vdc 4
2008 Jan 17 16:29:28 dc3-test %SYSMGR-2-SWITCHOVER_OVER: Switchover completed.
2008 Jan 17 16:29:28 dc3-test %DAEMON-3-SYSTEM_MSG: ntp:socket family : 2 - ntpd[19045]
2008 Jan 17 16:29:28 dc3-test %DAEMON-3-SYSTEM_MSG: ntp:socket family : 10 - ntpd[19045]
2008 Jan 17 16:29:28 dc3-test %DAEMON-3-SYSTEM_MSG: ntp:ipv6 only defined - ntpd[19045]
2008 Jan 17 16:29:28 dc3-test %DAEMON-3-SYSTEM_MSG: ntp:bindv6 only defined - ntpd[19045]
2008 Jan 17 16:29:28 dc3-test %DAEMON-3-SYSTEM_MSG: ntp:socket family : 2 - ntpd[19045]
2008 Jan 17 16:29:28 dc3-test %DAEMON-3-SYSTEM_MSG: ntp:socket family : 0 - ntpd[19045]
2008 Jan 17 16:29:28 dc3-test %DAEMON-3-SYSTEM_MSG: ntp:socket family : 0 - ntpd[19045]
2008 Jan 17 16:29:28 dc3-test %NETSTACK-3-CLIENT_GET: netstack [4336] HA client filter
recovery failed (0)
2008 Jan 17 16:29:28 dc3-test %NETSTACK-3-CLIENT_GET: netstack [4336] HA client filter
recovery failed (0)
2008 Jan 17 16:29:29 dc3-test %DAEMON-3-SYSTEM_MSG: ssh disabled, removing
- dcos-xinetd[19072]
2008 Jan 17 16:29:29 dc3-test %DAEMON-3-SYSTEM_MSG: Telnet disabled, removing
- dcos-xinetd[19072]
2008 Jan 17 16:29:31 dc3-test %DAEMON-3-SYSTEM_MSG: Telnet disabled, removing
- dcos-xinetd[19073]
2008 Jan 17 16:29:32 dc3-test %DAEMON-3-SYSTEM_MSG: ssh disabled, removing
- dcos-xinetd[19079]
2008 Jan 17 16:29:32 dc3-test %DAEMON-3-SYSTEM_MSG: Telnet disabled, removing
- dcos-xinetd[19079]
2008 Jan 17 16:29:34 dc3-test %IM-5-IM_INTF_STATE: mgmt0 is UP in vdc 1
2008 Jan 17 16:29:34 dc3-test %IM-5-IM_INTF_STATE: mgmt0 is UP in vdc 2
2008 Jan 17 16:29:34 dc3-test %IM-5-IM_INTF_STATE: mgmt0 is UP in vdc 3
2008 Jan 17 16:29:34 dc3-test %IM-5-IM_INTF_STATE: mgmt0 is UP in vdc 4
2008 Jan 17 16:29:34 dc3-test %DAEMON-3-SYSTEM_MSG: ssh disabled, removing
- dcos-xinetd[19105]
2008 Jan 17 16:29:34 dc3-test %DAEMON-3-SYSTEM_MSG: Telnet disabled, removing -

```

```

dcos-xinetd[19105]
2008 Jan 17 16:29:35 dc3-test %PLATFORM-2-PS_AC_IN_MISSING: Power supply 2 present but all
AC
inputs are not
connected, ac-redundancy might be affected
2008 Jan 17 16:29:35 dc3-test %PLATFORM-2-PS_AC_IN_MISSING: Power supply 3 present but all
AC
inputs are not
connected, ac-redundancy might be affected
2008 Jan 17 16:29:38 dc3-test %CALLHOME-2-EVENT: SUP_FAILURE
2008 Jan 17 16:29:46 dc3-test vsh[19166]: CLIC-3-FAILED_EXEC: Can not exec command <more>
return code <14>
2008 Jan 17 16:30:24 dc3-test vsh[23810]: CLIC-3-FAILED_EXEC: Can not exec command <more>
return code <14>
2008 Jan 17 16:30:24 dc3-test vsh[23803]: CLIC-3-FAILED_EXEC: Can not exec command <more>
return code <14>
2008 Jan 17 16:30:24 dc3-test vsh[23818]: CLIC-3-FAILED_EXEC: Can not exec command <more>
return code <14>
2008 Jan 17 16:30:47 dc3-test %SYSMGR-3-BASIC_TRACE: core_copy: PID 2630 with message Core
not generated by
system for eltm(0). WCOREDUMP(9) returned zero .
2008 Jan 17 16:30:47 dc3-test %SYSMGR-2-SERVICE_CRASHED: Service "eltm" (PID 4820) hasn't
caught signal 9 (no core).
2008 Jan 17 16:31:02 dc3-test %SYSMGR-3-BASIC_TRACE: core_copy: PID 2630 with message Core
not generated by
system for eltm(0). WCOREDUMP(9) returned zero .
2008 Jan 17 16:31:02 dc3-test %SYSMGR-2-SERVICE_CRASHED: Service "eltm" (PID 24239) hasn't
caught signal 9
(no core).
2008 Jan 17 16:31:14 dc3-test %SYSMGR-3-BASIC_TRACE: core_copy: PID 2630 with message Core
not generated by
system for eltm(0). WCOREDUMP(9) returned zero .
2008 Jan 17 16:31:14 dc3-test %SYSMGR-2-SERVICE_CRASHED: Service "eltm" (PID 24401) hasn't
caught signal 9
(no core).
2008 Jan 17 16:31:23 dc3-test %CALLHOME-2-EVENT: SW_CRASH alert for service: eltm
2008 Jan 17 16:31:23 dc3-test %SYSMGR-3-BASIC_TRACE: core_copy: PID 2630 with message Core
not generated by
system for eltm(0). WCOREDUMP(9) returned zero .
2008 Jan 17 16:31:23 dc3-test %SYSMGR-2-SERVICE_CRASHED: Service "eltm" (PID 24407) hasn't
caught signal 9
(no core).
2008 Jan 17 16:31:24 dc3-test vsh[24532]: CLIC-3-FAILED_EXEC: Can not exec command <more>
return code <14>
2008 Jan 17 16:31:24 dc3-test vsh[24548]: CLIC-3-FAILED_EXEC: Can not exec command <more>
return code <14>
2008 Jan 17 16:31:24 dc3-test vsh[24535]: CLIC-3-FAILED_EXEC: Can not exec command <more>
return code <14>
2008 Jan 17 16:31:33 dc3-test %NETSTACK-3-INTERNAL_ERROR: netstack [4336] (null)
2008 Jan 17 16:31:33 dc3-test %ETHPORT-2-IF_SEQ_ERROR: Error (0x20) while communicating
with component MTS_SAP_ELTM
opcode:MTS OPC_ETHPM_PORT_PHY_CLEANUP (for:RID_PORT: Ethernet3/1) end attachment start
attachment
name:show vdc membership
type:text
data:
vdc_id: 1 vdc_name: dc3-test interfaces:
Ethernet3/1 Ethernet3/2 Ethernet3/3
Ethernet3/4 Ethernet3/5 Ethernet3/6
Ethernet3/7 Ethernet3/8 Ethernet3/9
Ethernet3/10 Ethernet3/11 Ethernet3/12
Ethernet3/13 Ethernet3/14 Ethernet3/15
Ethernet3/16 Ethernet3/17 Ethernet3/18
Ethernet3/19 Ethernet3/20 Ethernet3/21

```

```

Ethernet3/22 Ethernet3/23 Ethernet3/24
Ethernet3/25 Ethernet3/26 Ethernet3/27
Ethernet3/28 Ethernet3/29 Ethernet3/30
Ethernet3/31 Ethernet3/32 Ethernet3/33
Ethernet3/34 Ethernet3/35 Ethernet3/36
Ethernet3/37 Ethernet3/38 Ethernet3/39
Ethernet3/40 Ethernet3/41 Ethernet3/42
Ethernet3/43 Ethernet3/44 Ethernet3/45
Ethernet3/46 Ethernet3/47 Ethernet3/48
vdc_id: 2 vdc_name: dc3-aaa interfaces:
vdc_id: 3 vdc_name: dc3-rbac interfaces:
vdc_id: 4 vdc_name: dc3-call interfaces:
end attachment
start attachment name:show vdc current-vdc
type:text
data:
Current vdc is 1 - dc3-test
end attachment
start attachment
name:show license usage
type:text
data:
Feature Ins Lic Status Expiry Date Comments
Count
-----
LAN_ADVANCED_SERVICES_PKG Yes - In use Never -
LAN_ENTERPRISE_SERVICES_PKG Yes - Unused Never -
-----
end attachment

```

6.10.4 Sample Syslog Alert Notification in XML Format

This sample shows the XML format for a syslog port alert-group notification:

```

<?xml version="1.0" encoding="UTF-8" ?>
<soap-env:Envelope xmlns:soap-env="http://www.w3.org/2003/05/soap-envelope">
<soap-env:Header>
<aml-session:Session xmlns:aml-session="http://www.Inspur.com/2004/01/aml-
session" soap-env:mustUnderstand="true"
soap-env:role="http://www.w3.org/2003/05/soap-envelope/role/next">
<aml-session:To>http://tools.Inspur.com/neddce/services/DDCEService</aml-session:To>
<aml-session:Path>
<aml-session:Via>http://www.Inspur.com/appliance/uri</aml-session:Via>
</aml-session:Path>
<aml-session:From>http://www.Inspur.com/appliance/uri</aml-session:From>
<aml-session:MessageId>1004:TXX12345678:478F82E6</aml-session:MessageId>
</aml-session:Session>
</soap-env:Header>
<soap-env:Body>
<aml-block:Block xmlns:aml-block="http://www.Inspur.com/2004/01/aml-block">
<aml-block:Header>
<aml-block:Type>http://www.Inspur.com/2005/05/callhome/syslog</aml-block:Type>
<aml-block:CreationDate>2008-01-17 16:31:33 GMT+0000</aml-block:CreationDate>
<aml-block:Builder>
<aml-block:Name>DC3</aml-block:Name>
<aml-block:Version>4.1</aml-block:Version>
</aml-block:Builder>
<aml-block:BlockGroup>
<aml-block:GroupId>1005:TXX12345678:478F82E6</aml-block:GroupId>
<aml-block:Number>0</aml-block:Number>
<aml-block:IsLast>true</aml-block:IsLast>

```



```

<aml-block:IsPrimary>>true</aml-block:IsPrimary>
<aml-block:WaitForPrimary>>false</aml-block:WaitForPrimary>
</aml-block:BlockGroup>
<aml-block:Severity>5</aml-block:Severity>
</aml-block:Header>
<aml-block:Content>
<ch:CallHome xmlns:ch="http://www.Inspur.com/2005/05/callhome" version="1.0">
<ch:EventTime>2008-01-17 16:31:33 GMT+0000</ch:EventTime>
  <ch:MessageDescription>SYSLOG_ALERT 2008 Jan 17 16:31:33
dc3-test %ETHPORT-2-IF_SEQ_ERROR: Error (0x20) while communicating with component
MTS_SAP_ELTm opcode:MTS_OPC_ETHPM_PORT_PHY_CLEANUP
(for:RID_PORT: Ethernet3/1) </ch:MessageDescription> <ch:Event> <ch:Type>syslog</ch:Type>
<ch:SubType></ch:SubType>
<ch:Brand>Inspur</ch:Brand> <ch:Series>CN7000</ch:Series> </ch:Event> <ch:CustomerData>
<ch:UserData>
<ch:Email>contact@example.com</ch:Email>
</ch:UserData>
<ch:ContractData>
<ch:DeviceId>CN127-C7010@C@TXX12345678</ch:DeviceId>
</ch:ContractData>
<ch:SystemInfo>
<ch>Name>dc3-test</ch>Name>
<ch>Contact>Jay Tester</ch>Contact> <ch>ContactEmail>contact@example.com</ch>ContactEmail>
<ch>ContactPhoneNumber>+91-80-1234-5678</ch>ContactPhoneNumber>
<ch:StreetAddress>#1, Any Street</ch:StreetAddress> </ch:SystemInfo> </ch:CustomerData>
<ch:Device>
<rme:Chassis xmlns:rme="http://www.Inspur.com/rme/4.1">
<rme:Model>CN127-C7010</rme:Model>
<rme:HardwareVersion>0.405</rme:HardwareVersion>
<rme:SerialNumber>TXX12345678</rme:SerialNumber>
</rme:Chassis>
</ch:Device>
</ch:CallHome>
</aml-block:Content>
<aml-block:Attachments>
<aml-block:Attachment type="inline">
<aml-block:Name>show logging logfile | tail -n 200</aml-block:Name> <aml-block:Data
encoding="plain">
<![CDATA[2008 Jan 17 10:57:51 dc3-test %SYSLOG-1-SYSTEM_MSG : Logging logfile (messages)
cleared by user
2008 Jan 17 10:57:53 dc3-test %VSHD-5-VSHD_SYSLOG_CONFIG_I: Configuring console from
/dev/ttyS0 /dev/ttyS0_console
2008 Jan 17 10:58:35 dc3-test %VSHD-5-VSHD_SYSLOG_CONFIG_I: Configuring console from
/dev/ttyS0 /dev/ttyS0_console
2008 Jan 17 10:59:00 dc3-test %DAEMON-3-SYSTEM_MSG: error: setsockopt IP_TOS 16: Invalid
argument: - sshd[14484]
2008 Jan 17 10:59:05 dc3-test %VSHD-5-VSHD_SYSLOG_CONFIG_I: Configuring console from
/dev/ttyS0 /dev/ttyS0_console
2008 Jan 17 12:11:18 dc3-test %SYSMGR-STANDBY-5-SUBPROC_TERMINATED: \"System Manager (gsync
controller)\"
(PID 12000) has finished with error code SYSMGR_EXITCODE_GSYNCFAILED_NONFATAL (12).
2008 Jan 17 16:28:03 dc3-test %VSHD-5-VSHD_SYSLOG_CONFIG_I: Configuring console from
/dev/ttyS0 /dev/ttyS0_console
2008 Jan 17 16:28:44 dc3-test %SYSMGR-3-BASIC_TRACE: core_copy: PID 2579 with message Core
not generated by system
for eltm(0). WCOREDUMP(9) returned zero .
2008 Jan 17 16:28:44 dc3-test %SYSMGR-2-SERVICE_CRASHED: Service \"eltm\" (PID 3504)
hasn&apos;t caught signal 9
(no core).
2008 Jan 17 16:29:08 dc3-test %SYSMGR-3-BASIC_TRACE: core_copy: PID 2579 with message Core
not generated by system
for eltm(0). WCOREDUMP(9) returned zero .
2008 Jan 17 16:29:08 dc3-test %SYSMGR-2-SERVICE_CRASHED: Service \"eltm\" (PID 23210)
hasn&apos;t caught signal 9
]]>

```

```

(no core).
2008 Jan 17 16:29:17 dc3-test %SYSMGR-3-BASIC_TRACE: core_copy: PID 2579 with message Core
not generated by system
for eltm(0). WCOREDUMP(9) returned zero .
2008 Jan 17 16:29:17 dc3-test %SYSMGR-2-SERVICE_CRASHED: Service \"eltm\" (PID 23294)
hasn&apos;t caught signal 9
(no core).
2008 Jan 17 16:29:25 dc3-test %SYSMGR-2-HASWITCHOVER_PRE_START: This supervisor is
becoming active (pre-start phase).
2008 Jan 17 16:29:25 dc3-test %SYSMGR-2-HASWITCHOVER_START: This supervisor is becoming
active.
2008 Jan 17 16:29:26 dc3-test %USER-3-SYSTEM_MSG: crdcfg_get_srvinfo: mts_send failed -
device_test
2008 Jan 17 16:29:27 dc3-test %NETSTACK-3-IP_UNK_MSG_MAJOR: netstack [4336] Unrecognized
message from MRIB.
Major type 1807
2008 Jan 17 16:29:27 dc3-test %IM-5-IM_INTF_STATE: mgmt0 is DOWN in vdc 1
2008 Jan 17 16:29:27 dc3-test %IM-5-IM_INTF_STATE: mgmt0 is DOWN in vdc 2
2008 Jan 17 16:29:27 dc3-test %IM-5-IM_INTF_STATE: mgmt0 is DOWN in vdc 3
2008 Jan 17 16:29:27 dc3-test %IM-5-IM_INTF_STATE: mgmt0 is DOWN in vdc 4
2008 Jan 17 16:29:28 dc3-test %SYSMGR-2-SWITCHOVER_OVER: Switchover completed.
2008 Jan 17 16:29:28 dc3-test %DAEMON-3-SYSTEM_MSG: ntp:socket family : 2 - ntpd[19045]
2008 Jan 17 16:29:28 dc3-test %DAEMON-3-SYSTEM_MSG: ntp:socket family : 10 - ntpd[19045]
2008 Jan 17 16:29:28 dc3-test %DAEMON-3-SYSTEM_MSG: ntp:ipv6 only defined - ntpd[19045]
2008 Jan 17 16:29:28 dc3-test %DAEMON-3-SYSTEM_MSG: ntp:bindv6 only defined - ntpd[19045]
2008 Jan 17 16:29:28 dc3-test %DAEMON-3-SYSTEM_MSG: ntp:socket family : 2 - ntpd[19045]
2008 Jan 17 16:29:28 dc3-test %DAEMON-3-SYSTEM_MSG: ntp:socket family : 0 - ntpd[19045]
2008 Jan 17 16:29:28 dc3-test %DAEMON-3-SYSTEM_MSG: ntp:socket family : 0 - ntpd[19045]
2008 Jan 17 16:29:28 dc3-test %NETSTACK-3-CLIENT_GET: netstack [4336] HA client filter
recovery failed (0)
2008 Jan 17 16:29:28 dc3-test %NETSTACK-3-CLIENT_GET: netstack [4336] HA client filter
recovery failed (0)
2008 Jan 17 16:29:29 dc3-test %DAEMON-3-SYSTEM_MSG: ssh disabled, removing
- dcos-xinetd[19072]
2008 Jan 17 16:29:29 dc3-test %DAEMON-3-SYSTEM_MSG: Telnet disabled, removing
- dcos-xinetd[19072]
2008 Jan 17 16:29:31 dc3-test %DAEMON-3-SYSTEM_MSG: Telnet disabled, removing
- dcos-xinetd[19073]
2008 Jan 17 16:29:32 dc3-test %DAEMON-3-SYSTEM_MSG: ssh disabled, removing
- dcos-xinetd[19079]
2008 Jan 17 16:29:32 dc3-test %DAEMON-3-SYSTEM_MSG: Telnet disabled, removing
- dcos-xinetd[19079]
2008 Jan 17 16:29:34 dc3-test %IM-5-IM_INTF_STATE: mgmt0 is UP in vdc 1
2008 Jan 17 16:29:34 dc3-test %IM-5-IM_INTF_STATE: mgmt0 is UP in vdc 2
2008 Jan 17 16:29:34 dc3-test %IM-5-IM_INTF_STATE: mgmt0 is UP in vdc 3
2008 Jan 17 16:29:34 dc3-test %IM-5-IM_INTF_STATE: mgmt0 is UP in vdc 4
2008 Jan 17 16:29:34 dc3-test %DAEMON-3-SYSTEM_MSG: ssh disabled, removing
- dcos-xinetd[19105]
2008 Jan 17 16:29:34 dc3-test %DAEMON-3-SYSTEM_MSG: Telnet disabled, removing
- dcos-xinetd[19105]
2008 Jan 17 16:29:35 dc3-test %PLATFORM-2-PS_AC_IN_MISSING: Power supply 2 present but all
AC inputs are not
connected, ac-redundancy might be affected
2008 Jan 17 16:29:35 dc3-test %PLATFORM-2-PS_AC_IN_MISSING: Power supply 3 present but all
AC inputs are not
connected, ac-redundancy might be affected
2008 Jan 17 16:29:38 dc3-test %CALLHOME-2-EVENT: SUP_FAILURE
2008 Jan 17 16:29:46 dc3-test vsh[19166]: CLIC-3-FAILED_EXEC: Can not exec command
&lt;more&gt; return code &lt;14&gt;
2008 Jan 17 16:30:24 dc3-test vsh[23810]: CLIC-3-FAILED_EXEC: Can not exec command
&lt;more&gt; return code &lt;14&gt;
2008 Jan 17 16:30:24 dc3-test vsh[23803]: CLIC-3-FAILED_EXEC: Can not exec command
&lt;more&gt; return code &lt;14&gt;

```

```

2008 Jan 17 16:30:24 dc3-test vsh[23818]: CLIC-3-FAILED_EXEC: Can not exec command
&lt;more&gt; return code &lt;14&gt;
2008 Jan 17 16:30:47 dc3-test %SYSMGR-3-BASIC_TRACE: core_copy: PID 2630 with message Core
not generated by system
for eltm(0). WCOREDUMP(9) returned zero .
2008 Jan 17 16:30:47 dc3-test %SYSMGR-2-SERVICE_CRASHED: Service \"eltm\" (PID 4820)
hasn&apos;t caught signal 9 (no core).
2008 Jan 17 16:31:02 dc3-test %SYSMGR-3-BASIC_TRACE: core_copy: PID 2630 with message Core
not generated by system
for eltm(0). WCOREDUMP(9) returned zero .
2008 Jan 17 16:31:02 dc3-test %SYSMGR-2-SERVICE_CRASHED: Service \"eltm\" (PID 24239)
hasn&apos;t caught signal 9
(no core).
2008 Jan 17 16:31:14 dc3-test %SYSMGR-3-BASIC_TRACE: core_copy: PID 2630 with message Core
not generated by system
for eltm(0). WCOREDUMP(9) returned zero .
2008 Jan 17 16:31:14 dc3-test %SYSMGR-2-SERVICE_CRASHED: Service \"eltm\" (PID 24401)
hasn&apos;t caught signal 9
(no core).
2008 Jan 17 16:31:23 dc3-test %CALLHOME-2-EVENT: SW_CRASH alert for service: eltm
2008 Jan 17 16:31:23 dc3-test %SYSMGR-3-BASIC_TRACE: core_copy: PID 2630 with message Core
not generated by system
for eltm(0). WCOREDUMP(9) returned zero .
2008 Jan 17 16:31:23 dc3-test %SYSMGR-2-SERVICE_CRASHED: Service \"eltm\" (PID 24407)
hasn&apos;t caught signal 9
(no core).
2008 Jan 17 16:31:24 dc3-test vsh[24532]: CLIC-3-FAILED_EXEC: Can not exec command
&lt;more&gt; return code &lt;14&gt;
2008 Jan 17 16:31:24 dc3-test vsh[24548]: CLIC-3-FAILED_EXEC: Can not exec command
&lt;more&gt; return code &lt;14&gt;
2008 Jan 17 16:31:24 dc3-test vsh[24535]: CLIC-3-FAILED_EXEC: Can not exec command
&lt;more&gt; return code &lt;14&gt;
2008 Jan 17 16:31:33 dc3-test %NETSTACK-3-INTERNAL_ERROR: netstack [4336] (null)
2008 Jan 17 16:31:33 dc3-test %ETHPORT-2-IF_SEQ_ERROR: Error (0x20) while communicating
with component
MTS_SAP_ELTM opcode:MTS_OPC_ETHPM_PORT_PHY_CLEANUP (for:RID_PORT: Ethernet3/1) ]]>
</aml-block:Data>
</aml-block:Attachment> <aml-block:Attachment type="inline"> <aml-block:Name>show vdc
membership</aml-block:Name>
<aml-block:Data encoding="plain">
<![CDATA[ vdc_id: 1 vdc_name: dc3-test
interfaces: Ethernet3/1 Ethernet3/2
Ethernet3/3 Ethernet3/4 Ethernet3/5
Ethernet3/6 Ethernet3/7 Ethernet3/8
Ethernet3/9 Ethernet3/10 Ethernet3/11
Ethernet3/12 Ethernet3/13 Ethernet3/14
Ethernet3/15 Ethernet3/16 Ethernet3/17
Ethernet3/18 Ethernet3/19 Ethernet3/20
Ethernet3/21 Ethernet3/22 Ethernet3/23
Ethernet3/24 Ethernet3/25 Ethernet3/26
Ethernet3/27 Ethernet3/28 Ethernet3/29
Ethernet3/30 Ethernet3/31 Ethernet3/32
Ethernet3/33 Ethernet3/34 Ethernet3/35
Ethernet3/36 Ethernet3/37 Ethernet3/38
Ethernet3/39 Ethernet3/40 Ethernet3/41
Ethernet3/42 Ethernet3/43 Ethernet3/44
Ethernet3/45 Ethernet3/46 Ethernet3/47
Ethernet3/48 vdc_id: 2 vdc_name: dc3-aaa
interfaces: vdc_id: 3 vdc_name: dc3-rbac
interfaces: vdc_id: 4 vdc_name: dc3-call
interfaces:
]]>
</aml-block:Data>

```

```

</aml-block:Attachment>
<aml-block:Attachment type="inline">
<aml-block:Name>show vdc current-vdc</aml-block:Name> <aml-block:Data encoding="plain">
<![CDATA[Current vdc
is 1 - dc3-test ]]> </aml-block:Data> </aml-block:Attachment> <aml-block:Attachment
type="inline">
<aml-block:Name>show license usage</aml-block:Name> <aml-block:Data encoding="plain">
<![CDATA[Feature Ins Lic Status Expiry Date Comments
Count
-----
LAN_ADVANCED_SERVICES_PKG Yes - In use Never -
LAN_ENTERPRISE_SERVICES_PKG Yes - Unused Never -
-----
]]>
</aml-block:Data>
</aml-block:Attachment>
</aml-block:Attachments>
</aml-block:Block>
</soap-env:Body>
</soap-env:Envelope>

```

6.10.5 Additional References

6.10.5.1 Related Documents

Related Topic	Document Title
Smart Call CLI commands	<i>Inspur CN12700 Series INOS System Management Command Reference</i>
VDCs and VRFs	<i>Inspur CN12700 Series INOS Virtual Device Context Configuration Guide</i>

6.11 Feature History for Smart Call Home

The table below summarizes the new and changed features for this document and shows the releases in which each feature is supported. Your software release might not support all the features in this document. For the latest caveats and feature information, the release notes for your software release.

Table 16 Feature History for Smart Call Home

Feature Name	Releases	Feature Information
HTTP proxy server	5.2(1)	Added the ability to send HTTP messages through an HTTP proxy server.
SMTP server configuration	5.0(2)	Added the ability to configure multiple SMTP servers.
VRF support for HTTP transport of Smart Call Home messages	5.0(2)	VRFs can be used to send e-mail and other Smart Call Home messages over HTTP.
Crash notifications	4.0(1)	Messages are sent for process crashes on line cards.
Destination profile configuration	4.1(3)	The commands destination-profile http and destination-profile transport-method cannot be distributed.

CHAPTER 7 Configuring Rollback

This chapter describes how to configure rollback on Inspur INOS devices. This chapter contains the following sections:

- Finding Feature Information
- About Rollbacks
- Licensing Requirements for Rollbacks
- Prerequisites for Rollbacks
- Guidelines and Limitations for Rollbacks
- Default Settings for Rollbacks
- Configuring Rollbacks
- Verifying the Rollback Configuration
- Configuration Example for Rollback
- Additional References
- Feature History for Rollback

7.1 Finding Feature Information

Your software release might not support all the features documented in this module. For the latest caveats and feature information, the release notes for your software release. To find information about the features documented in this module, and to see a list of the releases in which each feature is supported, see the "New and Changed Information" chapter or the Feature History table in this chapter.

7.2 About Rollbacks

A rollback allows you to take a snapshot, or user checkpoint, of the Inspur INOS configuration and then reapply that configuration to your device at any point without having to reload the device. A rollback allows any authorized administrator to apply this checkpoint configuration without requiring expert knowledge of the features configured in the checkpoint.

Inspur INOS automatically creates system checkpoints. You can use either a user or system checkpoint to perform a rollback.

You can create a checkpoint copy of the current running configuration at any time. Inspur INOS saves this checkpoint as an ASCII file which you can use to roll back the running configuration to the checkpoint

configuration at a future time. You can create multiple checkpoints to save different versions of your running configuration.

When you roll back the running configuration, you can trigger the following rollback types:

- atomic—Implement a rollback only if no errors occur.
- best-effort—Implement a rollback and skip any errors.
- stop-at-first-failure—Implement a rollback that stops if an error occurs. The default rollback type is atomic.

When you are ready to roll back to a checkpoint configuration, you can view the changes that will be applied to your current running configuration before committing to the rollback operation. If an error occurs during the rollback operation, you can choose to cancel the operation, or ignore the error and proceed with the rollback. If you cancel the operation, Inspur INOS provides a list of changes already applied before the error occurred. You need to clean up these changes manually.

7.2.1 Automatically Generated System Checkpoints

The Inspur INOS software automatically generates system checkpoints to help you avoid a loss of configuration information. System checkpoints are generated by the following events:

- Disabling an enabled feature with the no feature command
- Removing an instance of a Layer 3 protocol, such as with the no router bgp command or the no ip pim sparse-mode command
- License expiration of a feature

If one of these events causes system configuration changes, the feature software creates a system checkpoint that you can use to roll back to the previous system configuration. The system generated checkpoint filenames begin with “system-” and include the feature name. For example, the first time that you disable the EIGRP feature, the system creates the checkpoint named system-fm- inst_1 eigrp.

7.2.2 High Availability

Whenever a checkpoint is created using the checkpoint or checkpoint checkpoint_name commands, the checkpoint is synchronized to the standby unit.

A rollback remembers the states of the checkpoint operation, so if the checkpoint operation is interrupted and the system is left in an inconsistent state, a rollback can complete the checkpoint operation (synchronize the checkpoint with the standby unit) before proceeding with the rollback operation.

Your checkpoint files are still available after a process restart or supervisor switchover. Even if there is an interruption during the process restart or supervisor switchover, the checkpoint will complete successfully before proceeding with the operation. In a supervisor switchover, the checkpoint is completed on the new active unit.

If a process restart or supervisor switchover occurs during a rollback operation, after the restart or switchover completes, the rollback will resume from its previous state and complete successfully.

7.2.3 Virtualization Support

Inspur INOS creates a checkpoint of the running configuration in the virtual device context (VDC) that you are logged into. You can create different checkpoint copies in each VDC. You cannot apply the checkpoint of one VDC into another VDC. By default, Inspur INOS places you in the default VDC. See the *Inspur CN12700 Series INOS Virtual Device Context Configuration Guide*.

VDC configuration does not support checkpoints for any operations, including (but not limited to) VDC creation, VDC deletion, VDC suspension, VDC reloading, VDC renaming, VDC interface allocation, shared interface allocation, FCoE VLAN allocation, resource allocation, and resource templates. You should create your checkpoint from within a specific VDC.

7.3 Licensing Requirements for Rollbacks

Product	License Requirement
Inspur INOS	The rollback feature requires no license. Any feature not included in a license package is bundled with the INOS image and is provided at no extra charge to you. For a complete explanation of the Inspur INOS licensing scheme, see the <i>Inspur INOS Licensing Guide</i> .

7.4 Prerequisites for Rollbacks

To configure rollback, you must have network-admin user privileges.

If you configure VDCs, install the appropriate license and go to the specific VDC. See the *Inspur CN12700 Series INOS Virtual Device Context Configuration Guide* for configuration information and the *Inspur INOS Licensing Guide* for licensing information.

7.5 Guidelines and Limitations for Rollbacks

Rollbacks have the following configuration guidelines and limitations:

- You can create up to ten checkpoint copies.
 - Your checkpoint filenames must be 80 characters or less.
 - You cannot apply a checkpoint configuration in a nondefault VDC if there is a change in the global configuration portion of the running configuration compared to the checkpoint configuration.
 - Your checkpoint filenames must be 80 characters or less.
 - You cannot start a checkpoint filename with the word *system*.
 - Beginning in Inspur INOS Release 4.2(1), you can start a checkpoint filename with the word *auto*.
 - Beginning in Inspur INOS Release 4.2(1), you can name a checkpoint file *summary* or any abbreviation of the word *summary*.
 - Only one user can perform a checkpoint, rollback, or copy the running configuration to the startup configuration at the same time.
 - After the system executes the **write erase** or **reload** command, checkpoints are deleted. You can use the **clear checkpoint database** command to clear out all checkpoint files.
 - A rollback fails for NetFlow if during a rollback, you try to modify a record that is programmed in the hardware.
 - Although a rollback is not supported for checkpoints across software versions, users can perform a rollback at their own discretion and can use the best-effort mode to recover from errors.
 - When checkpoints are created on bootflash, differences with the running-system configuration cannot be performed before performing the rollback, and the system reports “No Changes.”
 - Checkpoints are local to a virtual device context (VDC).
 - Checkpoints created using the **checkpoint** and **checkpoint checkpoint_name** commands are present upon a switchover.
 - Checkpoints created in the default VDC are present upon reload unless a **write-erase** command is issued before a reload.
 - Checkpoints created in nondefault VDCs are present upon reload only if a **copy running-config startup-config** command is issued in the applicable VDC *and* the default VDC.
 - A rollback to files on bootflash is supported only on files created using the **checkpoint checkpoint_name** command and not on any other type of ASCII file.
 - Checkpoint names must be unique. You cannot overwrite previously saved checkpoints with the same name.
 - Rollback is not supported in the storage VDC.
 - Rollback is not supported in the Admin virtual device context (VDC) feature.
 - Configure the **terminal dont-ask** command before executing the **rollback** command to a checkpoint. In a rollback patch, the rollback process does not pause for user interaction and takes the default values for interactive commands. Configuring the **terminal dont-ask** command before executing the **rollback** command helps in resolving this issue.
 - Rollback is not supported in the context of auto configurations. Checkpoints do not store auto configurations. Therefore, after a rollback is performed, the corresponding auto configurations will not be present.
 - When you perform rollback, if the patch contains the **reload** command for the corresponding module along with the configuration commands for that module, rollback fails. This is because the rollback action does not wait for the module to come online; it starts executing the configuration commands on the module even as the reload process is in progress. To resolve this issue, manually execute the configuration commands for the module *after* the module is online.
- Examples:
- A rollback fails when you execute the **bfd hw-offload-module** command or the **no** form of this command. In this instance, failure is because rollback cannot execute these commands when the switch interfaces that are a part of the BFD sessions are powered up. To resolve this issue, shut down all the interfaces that are a part of the BFD sessions using the **shutdown** command before executing the **bfd hw-offload-module** command or the **no** form of this command.

- The following BFD command configurations are not supported during a rollback configuration:
 - **bfd {ipv4 | ipv6} echo**
 - **bfd {ipv4 | ipv6} per-link**
 - **bfd hw-offload-module** *module-number*
 - **port-channel bfd track-member-link**
 - **port-channel bfd destination** *destination-ip-address*
- When an FEX is being configured while a rollback vPC is applied to an interface, the FEX goes offline momentarily. When this occurs, rollback does not wait for the FEX to come online, and executes the configuration commands for the interface, resulting in failure because the corresponding FEX is not yet provisioned. To resolve this issue, manually execute the FEX-related configuration commands *after* the FEX is online.
- Checkpoint descriptions are not persistent across switch reloads. When a description for a checkpoint is created by using the **checkpoint** *description* command, the description is not visible in the output of the **show checkpoint summary** command after the switch is reloaded. If the checkpoint description can be qualified as a checkpoint name, we recommend using the same alphanumeric string for both the checkpoint name and description. The checkpoint name is visible in the output of the **show checkpoint summary** command even after the switch is reloaded

7.6 Default Settings for Rollbacks

This table lists the default settings for rollback parameters.

Parameters	Default
Rollback type	Atomic

7.7 Configuring Rollbacks

7.7.1 Creating a Checkpoint

You can create up to ten checkpoints of your configuration.

Procedure

	Command or Action	Purpose
Step 1	[no] checkpoint {[<i>cp-name</i>] [description <i>descr</i>] file <i>file-name</i> } Example: switch# checkpoint stable	Creates a checkpoint of the running configuration to either a user checkpoint name or a file. The checkpoint name can be any alphanumeric string up to 80 characters but cannot contain spaces. If you do not provide a name, Inspur INOS sets the checkpoint name to user-checkpoint- <i>number</i> where <i>number</i> is from 1 to 10. The description can contain up to 80 alphanumeric characters, including spaces. You can use the no form of the checkpoint command to remove a checkpoint name. Use the delete command to remove a checkpoint file.
Step 2	(Optional) show checkpoint <i>cp-name</i> [all] Example: switch# show checkpoint stable	Displays the contents of the checkpoint name.

7.7.2 Implementing a Rollback

You can implement a rollback to a checkpoint name or file. Before you implement a rollback, you can view the differences between source and destination checkpoints that reference current or saved configurations.

Procedure

	Command or Action	Purpose
Step 1	show diff rollback-patch { checkpoint <i>src-cp-name</i> running-config startup-config file <i>source-file</i> } { checkpoint <i>dest-cp-name</i> running-config startup-config file <i>dest-file</i> } Example: switch# show diff rollback-patch checkpoint stable running-config	Displays the differences between the source and destination checkpoint selections.
Step 2	rollback running-config { checkpoint <i>cp-name</i> file <i>cp-file</i> } [atomic best-effort stop-at-first-failure] Example: switch# rollback running-config checkpoint stable	Creates a rollback to the specified checkpoint name or file. You can implement the following rollback types: <ul style="list-style-type: none"> • atomic—Implement a rollback only if no errors occur. • best-effort—Implement a rollback and skip any errors. • stop-at-first-failure—Implement a rollback that stops if an error occurs. The default is atomic. This example shows how to implement a rollback to a user checkpoint name.

7.8 Verifying the Rollback Configuration

To display the rollback configuration information, perform one of the following tasks:

Command	Purpose
show checkpoint <i>name</i> [all]	Displays the contents of the checkpoint name.
show checkpoint all [user system]	Displays the contents of all checkpoints. You can limit the displayed checkpoints to user or system generated checkpoints.
show checkpoint summary [user system]	Displays a list of all checkpoints. You can limit the displayed checkpoints to user or system generated checkpoints.
show diff rollback-patch { checkpoint <i>src-cp-name</i> running-config startup-config file <i>source-file</i> } { checkpoint <i>dest-cp-name</i> running-config startup-config file <i>dest-file</i> }	Displays the differences between the source and destination checkpoint selections.
show rollback log [exec verify]	Displays the contents of the rollback log.

Use the clear checkpoint database command to delete all checkpoint files.

7.9 Configuration Example for Rollback

This example shows how to create a checkpoint file and then implements a best-effort rollback to a user checkpoint name:

```
checkpoint stable
rollback running-config checkpoint stable best-effort
```

7.10 Feature History for Rollback

The table below summarizes the new and changed features for this document and shows the releases in which each feature is supported. Your software release might not support all the features in this document. For the latest caveats and feature information, the release notes for your software release.

Table 17 Feature History for Rollback

Feature Name	Releases	Feature Information
High Availability	4.2(1)	Checkpoint and rollback operations support high availability.
Guidelines and Limitations	4.2(1)	Checkpoint file naming conventions changed.
Automatically generated system checkpoints	4.2(1)	The software automatically generates a system checkpoint when disabling a feature or license expiration could cause loss of configuration information.
Guidelines and Limitations	4.1(3)	A rollback fails for NetFlow if during rollback, you try to modify a record that is programmed in the hardware. A rollback is not supported for checkpoints across software versions.

CHAPTER 8 Configuring Session Manager

This chapter describes how to configure Session Manager on Inspur INOS devices. This chapter contains the following sections:

- Finding Feature Information
- About Session Manager
- Licensing Requirements for Session Manager
- Prerequisites for Session Manager
- Guidelines and Limitations for Session Manager
- Configuring Session Manager
- Verifying the Session Manager Configuration
- Configuration Example for Session Manager
- Additional References
- Feature History for Session Manager

8.1 Finding Feature Information

Your software release might not support all the features documented in this module. For the latest caveats and feature information, the release notes for your software release. To find information about the features documented in this module, and to see a list of the releases in which each feature is supported, see the "New and Changed Information" chapter or the Feature History table in this chapter.

8.2 About Session Manager

Session Manager allows you to implement your configuration changes in batch mode. Session Manager works in the following phases:

- Configuration session—Creates a list of commands that you want to implement in Session Manager mode.
- Validation—Provides a basic semantic check on your configuration. Inspur INOS returns an error if the semantic check fails on any part of the configuration.
 - Verification—Verifies the configuration as a whole, based on the existing hardware and software configuration and resources. Inspur INOS returns an error if the configuration does not pass this verification phase.
 - Commit—Inspur INOS verifies the complete configuration and applies the changes to the device. If a failure occurs, Inspur INOS reverts to the original configuration.
 - Abort—Discards the configuration changes before implementation.

You can optionally end a configuration session without committing the changes. You can also save a configuration session.

8.2.1 High Availability

Session Manager sessions remain available after a supervisor switchover. Sessions are not persistent across a software reload.

8.2.2 Virtualization Support

By default, Inspur INOS places you in the default VDC. See the *Inspur CN12700 Series INOS Virtual Device Context Configuration Guide*.

8.3 Licensing Requirements for Session Manager

Product	License Requirement
Inspur INOS	Session Manager requires no license. Any feature not included in a license package is bundled with the INOS image and is provided at no extra charge to you. For a complete explanation of the Inspur INOS licensing scheme, see the <i>Inspur INOS Licensing Guide</i> .

8.4 Prerequisites for Session Manager

Make sure that you have the privilege level required to support the Session Manager commands that you plan to use.

If you configure VDCs, install the appropriate license and go to the specific VDC. See the Inspur CN12700 Series INOS Virtual Device Context Configuration Guide for configuration information and the Inspur INOS Licensing Guide for licensing information.

8.5 Guidelines and Limitations for Session Manager

Session Manager has the following configuration guidelines and limitations:

- Session Manager supports only access control list (ACL) and quality of service (QoS) features.
- You can create up to 32 configuration sessions.
- You cannot issue an in-service software upgrade (ISSU) if an active session is in progress. You must commit the session, save it, or abort it before issuing an ISSU.
- You can configure a maximum of 20,000 commands across all sessions.
- You cannot simultaneously execute configuration commands in more than one configuration session or configuration terminal mode. Parallel configurations (for example, one configuration session and one configuration terminal) might cause validation or verification failures in the configuration session.
- If an interface reloads while you are configuring that interface in a configuration session, Session Manager may accept the commands even though the interface is not present in the device at that time.

8.6 Configuring Session Manager

8.6.1 Creating a Session

You can create up to 32 configuration sessions.

Procedure

	Command or Action	Purpose
Step 1	configure session <i>name</i> Example: switch# configure session myACLs switch(config-s)#	Creates a configuration session and enters session configuration mode. The name can be any alphanumeric string. Displays the contents of the session.
Step 2	(Optional) show configuration session [<i>name</i>] Example: switch(config-s)# show configuration session myACLs	Displays the contents of the session.
Step 3	(Optional) save <i>location</i>	Saves the session to a file. The location can be in

	Command or Action	Purpose
	Example: switch(config-s)# save bootflash:sessions/myACLs	bootflash:, slot0:, or volatile:.

8.6.2 Configuring ACLs in a Session

You can configure ACLs within a configuration session.

Procedure

	Command or Action	Purpose
Step 1	configure session <i>name</i> Example: switch# configure session myacls switch(config-s)#	Creates a configuration session and enters session configuration mode. The name can be any alphanumeric string.
Step 2	ip access-list <i>name</i> Example: switch(config-s)# ip access-list acl1 switch(config-s-acl)#	Creates an ACL and enters a configuration mode for that ACL.
Step 3	(Optional) permit <i>protocol source destination</i> Example: switch(config-s-acl)# permit tcp any any	Adds a permit statement to the ACL.
Step 4	interface <i>interface-type number</i> Example: switch(config-s-acl)# interface e 2/1 switch(config-s-if)#	Enters interface configuration mode.
Step 5	ip access-group <i>name {in out}</i> Example: switch(config-s-if)# ip access-group acl1 in	Specifies the direction of traffic the access group is applied to.
Step 6	(Optional) show configuration session [<i>name</i>] Example: switch(config-s)# show configuration session myacls	Displays the contents of the session.

8.6.3 Verifying a Session

Use the following command in session mode to verify a session:

Command	Purpose
verify [verbose] Example: switch(config-s)# verify	Verifies the configuration as a whole, based on the existing hardware and software configuration and resources. Inspur INOS returns an error if the configuration does not pass this verification.

8.6.4 Committing a Session

Use the following command in session mode to commit a session:

Command	Purpose
commit [verbose]	Validates the configuration changes made in the current session and applies valid

Command	Purpose
Example: switch(config-s)# commit	changes to the device. If the validation fails, Inspur INOS reverts to the original configuration.

8.6.5 Saving a Session

Use the following command in session mode to save a session:

Command	Purpose
save <i>location</i> Example: switch(config-s)# save bootflash:sessions/myACLs	(Optional) Saves the session to a file. The location can be in bootflash:, slot0:, or volatile:.

8.6.6 Discarding a Session

Use the following command in session mode to discard a session:

Command	Purpose
abort Example: switch(config-s)# abort switch#	Discards the configuration session without applying the changes.

8.7 Verifying the Session Manager Configuration

To display the Session Manager configuration information, perform one of the following tasks:

Command	Purpose
show configuration session [<i>name</i>]	Displays the contents of the configuration session.
show configuration session status [<i>name</i>]	Displays the status of the configuration session.
show configuration session summary	Displays a summary of all the configuration sessions.

8.8 Configuration Example for Session Manager

This example shows how to create and commit an ACL configuration using Session Manager:

```
switch# configure session ACL_tcp_in
Config Session started, Session ID is 1
Enter configuration commands, one per line. End with CNTL/Z.
switch(config-s)# ip access-list ACL1
switch(config-s-acl)# permit tcp any any
switch(config)# interface e 7/1
switch(config-if)# ip access-group ACL1 in
switch(config-if)# exit
switch(config)# exit
switch# config session ACL_tcp_in
Config Session started, Session ID is 1
Enter configuration commands, one per line. End with CNTL/Z.
switch(config-s)# verify
Verification Successful
switch(config-s)# commit
Commit Successful
switch#
```

8.9 Feature History for Session Manager

The table below summarizes the new and changed features for this document and shows the releases in which each feature is supported. Your software release might not support all the features in this document. For the latest caveats and feature information, the release notes for your software release.

Table 18 Feature History for Session Manager

Feature Name	Releases	Feature Information
Session Manager	4.0(1)	This feature was introduced.

CHAPTER 9 Configuring the Scheduler

This chapter describes how to configure the scheduler on Inspur INOS devices. This chapter includes the following sections:

- Finding Feature Information
- About the Scheduler
- Licensing Requirements for the Scheduler
- Prerequisites for the Scheduler
- Guidelines and Limitations for the Scheduler
- Default Settings for the Scheduler
- Configuring the Scheduler
- Verifying the Scheduler Configuration
- Configuration Examples for the Scheduler
- Related Documents
- Feature History for the Scheduler

9.1 Finding Feature Information

Your software release might not support all the features documented in this module. For the latest caveats and feature information, the release notes for your software release. To find information about the features documented in this module, and to see a list of the releases in which each feature is supported, see the "New and Changed Information" chapter or the Feature History table in this chapter.

9.2 About the Scheduler

The scheduler allows you to define and set a timetable for maintenance activities such as the following:

- Quality of service (QoS) policy changes
- Data backup
- Saving a configuration

Jobs consist of a single command or multiple commands that define routine activities. Jobs can be scheduled one time or at periodic intervals.

The scheduler defines a job and its timetable as follows:

- Job—A routine task or tasks defined as a command list and completed according to a specified schedule.
- Schedule—The timetable for completing a job. You can assign multiple jobs to a schedule. A schedule is defined as either periodic or one-time only:
 - Periodic mode—A recurring interval that continues until you delete the job. You can configure the following types of intervals:
 - Daily—A job is completed once a day.
 - Weekly—A job is completed once a week.
 - Monthly—A job is completed once a month.
 - Delta—A job begins at the specified start time and then at specified intervals (days:hours:minutes).
 - One-time mode—A job is completed only once at a specified time.

9.2.1 Remote User Authentication

Before starting a job, the scheduler authenticates the user who created the job. Since user credentials from a remote authentication are not retained long enough to support a scheduled job, you need to locally configure the authentication passwords for users who create jobs. These passwords are part of the scheduler configuration and are not considered a locally configured user.

Before starting the job, the scheduler validates the local password against the password from the remote authentication server.

9.2.2 Logs

The scheduler maintains a log file containing the job output. If the size of the job output is greater than the size of the log file, the output is truncated.

9.2.3 High Availability

Scheduled jobs remain available after a supervisor switchover or a software reload.

9.2.4 Virtualization Support

Jobs are created in the virtual device context (VDC) that you are logged into. By default, Inspur INOS places you in the default VDC. For more information, see the Inspur CN12700 Series INOS Virtual Device Context Configuration Guide.

9.3 Licensing Requirements for the Scheduler

Product	License Requirement
Inspur INOS	The scheduler requires no license. Any feature not included in a license package is bundled with the INOS image and is provided at no extra charge to you. For a complete explanation of the Inspur INOS licensing scheme, see the <i>Inspur INOS Licensing Guide</i> .

9.4 Prerequisites for the Scheduler

The scheduler has the following prerequisites:

- You must enable any conditional features before you can configure those features in a job.
- You must have a valid license installed for any licensed features that you want to configure in the job.
- You must have network-admin user privileges to configure a scheduled job.

9.5 Guidelines and Limitations for the Scheduler

The scheduler has the following configuration guidelines and limitations:

- The scheduler can fail if it encounters one of the following while performing a job:
 - If the license has expired for a feature at the time the job for that feature is scheduled.
 - If a feature is disabled at the time when a job for that feature is scheduled.
 - If you have removed a module from a slot and a job for that slot is scheduled.
- Verify that you have configured the time. The scheduler does not apply a default timetable. If you create a schedule and assign jobs and do not configure the time, the job is not started.
 - While defining a job, verify that no interactive or disruptive commands (for example, copy bootflash: file ftp: URI, write erase, and other similar commands) are specified because the job is started and conducted noninteractively.

9.6 Default Settings for the Scheduler

This table lists the scheduler default settings.

Parameters	Default
Scheduler state	Disabled
Log file size	16 KB

9.7 Configuring the Scheduler

9.7.1 Enabling or Disabling the Scheduler

You can enable the scheduler feature so that you can configure and schedule jobs, or you can disable the scheduler feature after it has been enabled.

Procedure

	Command or Action	Purpose
Step 1	switch# configure terminal	Enters global configuration mode.
Step 2	switch(config)# [no] feature scheduler	Enables or disables the scheduler.
Step 3	(Optional) switch(config)# show scheduler config	Displays the scheduler configuration.
Step 4	(Optional) switch(config)# copy running-config startup-config	Copies the running configuration to the startup configuration.

9.7.2 Defining the Scheduler Log File Size

You can configure the log file size for capturing jobs, schedules, and job output.

Procedure

	Command or Action	Purpose
Step 1	switch# configure terminal	Enters global configuration mode.
Step 2	switch(config)# scheduler logfile size value	Defines the scheduler log file size in kilobytes. The range is from 16 to 1024. The default is 16. Note If the size of the job output is greater than the size of the log file, then the output is truncated.
Step 3	(Optional) switch(config)# copy running-config startup-config	Copies the running configuration to the startup configuration.

9.7.3 Configuring Remote User Authentication

You can configure the scheduler to use remote authentication for users who want to configure and schedule jobs.

Procedure

	Command or Action	Purpose
Step 1	switch# configure terminal	Enters global configuration mode.

	Command or Action	Purpose
Step 2	switch(config)# scheduler aaa-authentication password [0 7] password	Configures a cleartext password for the user who is currently logged in.
Step 3	switch(config)# scheduler aaa-authentication username name password [0 7] password	Configures a cleartext password for a remote user.
Step 4	(Optional) switch(config)# show running-config include "scheduler aaa-authentication"	Displays the scheduler password information.
Step 5	(Optional) switch(config)# copy running-config startup-config	Copies the running configuration to the startup configuration.

9.7.4 Defining a Job

You can define a job including the job name and the command sequence.

Caution	Once a job is defined, you cannot modify or remove a command. To change the job, you must delete it and create a new one.
----------------	---

Procedure

	Command or Action	Purpose
Step 1	switch# configure terminal	Enters global configuration mode.
Step 2	switch(config)# scheduler job name string	Creates a job and enters job configuration mode. This example creates a scheduler job named backup-cfg.
Step 3	switch(config-job)# <i>command1</i> ;[<i>command2</i> ; <i>command3</i> ;...]	Defines the sequence of commands for the specified job. You must separate commands with a space and a semicolon (for example, “;”). This example creates a scheduler job that saves the running configuration to a file in bootflash and then copies the file from bootflash to a TFTP server. The filename is created using the current time stamp and switch name.
Step 4	(Optional) switch(config-job)# show scheduler job [name name]	Displays the job information.
Step 5	(Optional) switch(config)# copy running-config startup-config	Copies the running configuration to the startup configuration.

9.7.5 Deleting a Job

You can delete a job from the scheduler.

Procedure

	Command or Action	Purpose
Step 1	switch# configure terminal	Enters global configuration mode.
Step 2	switch(config)# no scheduler job name string	Deletes the specified job and all commands defined within it.
Step 3	(Optional) switch(config-job)# show scheduler job [name name]	Displays the job information.

	Command or Action	Purpose
Step 4	(Optional) switch(config)# copy running-config startup-config	Copies the running configuration to the startup configuration.

9.7.6 Defining a Timetable

You can define a timetable in the scheduler to be used with one or more jobs.

If you do not specify the time for the time commands, the scheduler assumes the current time. For example, if the current time is March 24, 2013, 22:00 hours, jobs are started as follows:

- For the time start 23:00 repeat 4:00:00 command, the scheduler assumes a start time of March 24, 2013, 23:00 hours.
- For the time daily 55 command, the scheduler assumes a start time every day at 22:55 hours.
- For the time weekly 23:00 command, the scheduler assumes a start time every Friday at 23:00 hours.

For the time monthly 23:00 command, the scheduler assumes a start time on the 24th of every month at 23:00 hours.

Procedure

	Command or Action	Purpose
Step 1	switch# configure terminal	Enters global configuration mode.
Step 2	switch(config)# scheduler schedule name string	Creates a new schedule and places you in schedule configuration mode for that schedule.
Step 3	switch(config-schedule)# job name string	Associates a job with this schedule. You can add multiple jobs to a schedule.
Step 4	switch(config-schedule)# time daily time	Indicates the job starts every day at a designated time specified as HH:MM.
Step 5	switch(config-schedule)# time weekly [[<i>dow</i> :]HH:]MM	Indicates that the job starts on a specified day of the week. Day of the week (<i>dow</i>) specified as one of the following: <ul style="list-style-type: none"> • An integer such as 1 = Sunday, 2 = Monday, and so on. • An abbreviation such as Sun = Sunday. <p>The maximum length for the entire argument is 10.</p>
Step 6	switch(config-schedule)# time monthly [[<i>dm</i> :]HH:]MM	Indicates the job starts on a specified day each month (<i>dm</i>). If you specify either 29, 30, or 31, the job is started on the last day of each month.
Step 7	switch(config-schedule)# time start {now repeat repeat-interval delta-time [repeat repeat-interval]}	Indicates the job starts periodically. The start-time format is [[[[yyyy:]mmm:]dd:]HH]:MM. <ul style="list-style-type: none"> • <i>delta-time</i>—Specifies the amount of time to wait after the schedule is configured before starting a job. • now—Specifies that the job starts now. • repeat repeat-interval—Specifies the frequency at which the job is repeated. <p>In this example, the job starts immediately and repeats every 48 hours.</p>
Step 8	(Optional) switch(config)# show scheduler config	Displays the scheduler configuration.
Step 9	(Optional) switch(config)# copy running-	Copies the running configuration to the startup

	Command or Action	Purpose
	config startup-config	configuration.

9.7.7 Clearing the Scheduler Log File

You can clear the scheduler log file.

Procedure

	Command or Action	Purpose
Step 1	switch# configure terminal	Enters global configuration mode.
Step 2	switch(config)# clear scheduler logfile	Clears the scheduler log file.

9.8 Verifying the Scheduler Configuration

To display the scheduler configuration information, perform one of the following tasks:

Command	Purpose
show scheduler config	Displays the scheduler configuration.
show scheduler job [name string]	Displays the jobs configured.
show scheduler logfile	Displays the contents of the scheduler log file.
show scheduler schedule [name string]	Displays the schedules configured.

9.9 Configuration Examples for the Scheduler

9.9.1 Creating a Scheduler Job

This example shows how to create a scheduler job that saves the running configuration to a file in bootflash and then copies the file from bootflash to a TFTP server (the filename is created using the current time stamp and switch name):

```
switch# configure terminal
switch(config)# scheduler job name backup-cfg
switch(config-job)# cli var name timestamp $(TIMESTAMP) ;copy running-config
bootflash:/${SWITCHNAME}-cfg.${timestamp} ;copy bootflash:/${SWITCHNAME}-
cfg.${timestamp} tftp://1.2.3.4/ vrf management
switch(config-job)# end
switch(config)#
```

9.9.2 Scheduling a Scheduler Job

This example shows how to schedule a scheduler job called backup-cfg to run daily at 1 a.m.:

```
switch# configure terminal
switch(config)# scheduler schedule name daily
switch(config-if)# job name backup-cfg
switch(config-if)# time daily 1:00
switch(config-if)# end
switch(config)#
```

9.9.3 Displaying the Job Schedule

This example shows how to display the job schedule:

```
switch# show scheduler schedule
Schedule Name : daily
-----
User Name : admin
Schedule Type : Run every day at 1 Hrs 00 Mins
Last Execution Time : Fri Jan 2 1:00:00 2013
Last Completion Time: Fri Jan 2 1:00:01 2013
Execution count : 2
-----
Job Name Last Execution Status
-----
back-cfg Success (0)
switch#
```

9.9.4 Displaying the Results of Running Scheduler Jobs

This example shows how to display the results of scheduler jobs that have been executed by the scheduler:

```
switch# show scheduler logfile
Job Name : back-cfg Job Status: Failed (1)
Schedule Name : daily User Name : admin
Completion time: Fri Jan 1 1:00:01 2013
----- Job Output -----
`cli var name timestamp 2013-01-01-01.00.00`
`copy running-config bootflash:/${HOSTNAME}-cfg.${timestamp}`
`copy bootflash:/switch-cfg.2013-01-01-01.00.00 tftp://1.2.3.4/ vrf management `
copy: cannot access file '/bootflash/switch-cfg.2013-01-01-01.00.00'
=====
Job Name : back-cfg Job Status: Success (0)
Schedule Name : daily User Name : admin
Completion time: Fri Jan 2 1:00:01 2013
----- Job Output -----
`cli var name timestamp 2013-01-02-01.00.00`
`copy running-config bootflash:/switch-cfg.2013-01-02-01.00.00`
`copy bootflash:/switch-cfg.2013--01-02-01.00.00 tftp://1.2.3.4/ vrf management `
Connection to Server Established.
[ ] 0.50KBTrying to connect to tftp server.....
[##### ] 24.50KB
TFTP put operation was successful
=====
switch#
```

9.10 Feature History for the Scheduler

The table below summarizes the new and changed features for this document and shows the releases in which each feature is supported. Your software release might not support all the features in this document. For the latest caveats and feature information, the release notes for your software release.

Table 19 Feature History for the Scheduler

Feature Name	Releases	Feature Information
Scheduler	4.0(1)	This feature was introduced.

CHAPTER 10 Configuring SNMP

This chapter describes how to configure the SNMP feature on Inspur INOS devices. This chapter contains the following sections:

- Finding Feature Information
- About SNMP
- Licensing Requirements for SNMP
- Prerequisites for SNMP
- Guidelines and Limitations for SNMP
- Default Settings for SNMP
- Configuring SNMP
- Verifying SNMP Configuration
- Configuration Examples for SNMP
- Additional References
- Feature History for SNMP

10.1 Finding Feature Information

Your software release might not support all the features documented in this module. For the latest caveats and feature information, the release notes for your software release. To find information about the features documented in this module, and to see a list of the releases in which each feature is supported, see the "New and Changed Information" chapter or the Feature History table in this chapter.

10.2 About SNMP

The Simple Network Management Protocol (SNMP) is an application-layer protocol that provides a message format for communication between SNMP managers and agents. SNMP provides a standardized framework and a common language used for the monitoring and management of devices in a network.

10.2.1 SNMP Functional Overview

The SNMP framework consists of three parts:

- An SNMP manager—The system used to control and monitor the activities of network devices using SNMP.
- An SNMP agent—The software component within the managed device that maintains the data for the device and reports these data, as needed, to managing systems. The Inspur CN device supports the agent and MIB. To enable the SNMP agent, you must define the relationship between the manager and the agent.
 - A managed information base (MIB)—The collection of managed objects on the SNMP agent

SNMP is defined in RFCs 3411 to 3418.

The device supports SNMPv1, SNMPv2c, and SNMPv3. Both SNMPv1 and SNMPv2c use a community-based form of security.

Inspur INOS supports SNMP over IPv6.

10.2.2 SNMP Notifications

A key feature of SNMP is the ability to generate notifications from an SNMP agent. These notifications do not require that requests be sent from the SNMP manager. Notifications can indicate improper user authentication, restarts, the closing of a connection, loss of connection to a neighbor router, or other significant events.

Inspur INOS generates SNMP notifications as either traps or informs. A trap is an asynchronous, unacknowledged message sent from the agent to the SNMP managers listed in the host receiver table. Informs are asynchronous messages sent from the SNMP agent to the SNMP manager which the manager must acknowledge receipt of.

Traps are less reliable than informs because the SNMP manager does not send any acknowledgment when it receives a trap. The device cannot determine if the trap was received. An SNMP manager that receives an inform request acknowledges the message with an SNMP response protocol data unit (PDU). If the device never receives a response, it can send the inform request again.

You can configure Inspur INOS to send notifications to multiple host receivers. The following table lists the SNMP traps that are enabled by default.

Trap Type	Description
generic	: coldStart
generic	: warmStart
entity	: entity_mib_change
entity	: entity_module_status_change
entity	: entity_power_status_change
entity	: entity_module_inserted
entity	: entity_module_removed
entity	: entity_unrecognised_module
entity	: entity_fan_status_change
entity	: entity_power_out_change
link	: linkDown
link	: linkUp
link	: extended-linkDown
link	: extended-linkUp
link	: cieLinkDown
link	: cieLinkUp
link	: delayed-link-state-change
rf	: redundancy_framework
license	: notify-license-expiry
license	: notify-no-license-for-feature
license	: notify-licensefile-missing
license	: notify-license-expiry-warning
upgrade	: UpgradeOpNotifyOnCompletion
upgrade	: UpgradeJobStatusNotify
rmon	: risingAlarm
rmon	: fallingAlarm
rmon	: hcRisingAlarm
rmon	: hcFallingAlarm
entity	: entity_sensor

10.2.3 SNMPv3

SNMPv3 provides secure access to devices by a combination of authenticating and encrypting frames over the network. The security features provided in SNMPv3 are the following:

- Message integrity—Ensures that a packet has not been tampered with in-transit.
- Authentication—Determines the message is from a valid source.
- Encryption—Scrambles the packet contents to prevent it from being seen by unauthorized sources.

SNMPv3 provides for both security models and security levels. A security model is an authentication strategy that is set up for a user and the role in which the user resides. A security level is the permitted level of security within a security model. A combination of a security model and a security level determines which security mechanism is employed when handling an SNMP packet.

10.2.3.1 Security Models and Levels for SNMPv1, v2, v3

The security level determines if an SNMP message needs to be protected from disclosure and if the message needs to be authenticated. The various security levels that exist within a security model are as follows:

- noAuthNoPriv—Security level that does not provide authentication or encryption.
- authNoPriv—Security level that provides authentication but does not provide encryption.
- authPriv—Security level that provides both authentication and encryption.

Three security models are available: SNMPv1, SNMPv2c, and SNMPv3. The security model combined with the security level determine the security mechanism applied when the SNMP message is processed. The following table identifies what the combinations of security models and levels mean.

Table 20 SNMP Security Models and Levels

Model	Level	Authentication	Encryption	What Happens
v1	noAuthNoPriv	Community string	No	Uses a community string match for authentication.
v2c	noAuthNoPriv	Community string	No	Uses a community string match for authentication.
v3	noAuthNoPriv	Username	No	Uses a username match for authentication.
v3	authNoPriv	HMAC-MD5 or HMAC-SHA	No	Provides authentication based on the Hash-Based Message Authentication Code (HMAC) Message Digest 5 (MD5) algorithm or the HMAC Secure Hash Algorithm (SHA).
v3	authPriv	HMAC-MD5 or HMAC-SHA	DES	Provides authentication based on the HMAC-MD5 or HMAC-SHA algorithms. Provides Data Encryption Standard (DES) 56-bit encryption in addition to authentication based on the Cipher Block Chaining (CBC) DES (DES-56) standard.

10.2.3.2 User-Based Security Model

The SNMPv3 User-Based Security Model (USM) refers to SNMP message-level security and offers the following services:

- Message integrity—Ensures that messages have not been altered or destroyed in an unauthorized manner and that data sequences have not been altered to an extent greater than can occur nonmaliciously.
- Message origin authentication—Ensures that the claimed identity of the user on whose behalf received data was originated is confirmed.
- Message confidentiality—Ensures that information is not made available or disclosed to unauthorized individuals, entities, or processes.

SNMPv3 authorizes management operations only by configured users and encrypts SNMP messages. Inspur INOS uses two authentication protocols for SNMPv3:

- HMAC-MD5-96 authentication protocol
- HMAC-SHA-96 authentication protocol

Inspur INOS uses Advanced Encryption Standard (AES) as one of the privacy protocols for SNMPv3 message encryption and conforms with RFC 3826.

The `priv` option offers a choice of DES or 128-bit AES encryption for SNMP security encryption. The `priv` option and the `aes-128` token indicate that this privacy password is for generating a 128-bit AES key. The AES `priv` password can have a minimum of eight characters. If the passphrases are specified in clear text, you can specify a maximum of 64 case-sensitive, alphanumeric characters. If you use the localized key, you can specify a maximum of 130 characters.

10.2.3.3 CLI and SNMP User Synchronization

SNMPv3 user management can be centralized at the Access Authentication and Accounting (AAA) server level. This centralized user management allows the SNMP agent in Inspur INOS to leverage the user authentication service of the AAA server. Once user authentication is verified, the SNMP PDUs are processed further. Additionally, the AAA server is also used to store user group names. SNMP uses the group names to apply the access/role policy that is locally available in the switch.

Any configuration changes made to the user group, role, or password results in database synchronization for both SNMP and AAA.

Inspur INOS synchronizes the user configuration in the following ways:

- The authentication passphrase specified in the `snmp-server user` command becomes the password for the CLI user.
- The password specified in the `username` command becomes the authentication and privacy passphrases for the SNMP user.
- If you create or delete a user using either SNMP or the CLI, the user is created or deleted for both SNMP and the CLI.
- User-role mapping changes are synchronized in SNMP and the CLI.
- Role changes (deletions or modifications) from the CLI are synchronized to SNMP.

10.2.3.4 AAA Exclusive Behavior in SNMPv3 Servers

The AAA exclusive behavior feature enables you to authenticate users based on location.

A unique SNMPv3 user is not authenticated if the user is not a local user or a remote AAA user. If the user exists in both the local and remote database, the user will be authenticated or rejected based on whether AAA exclusive behavior is enabled or not.

Table 21 AAA Exclusive Behavior Scenarios

User Location	AAA Server	AAA Exclusive Behavior	User Authentication
Local user database	Disabled	Enabled	User is authenticated.
Local user database	Enabled	Enabled	User is not authenticated.
Local user database	Enabled	Disabled	User is authenticated.
Local user database	Disabled	Disabled	User is authenticated.
Remote and local user databases (same username)	Enabled	Enabled	Remote user is authenticated, but the local user is not authenticated. ¹
Remote and local user databases (same username)	Disabled	Enabled	Local user is authenticated, but the remote user is not authenticated.
Remote and local user databases (same username)	Disabled	Disabled	Local user is authenticated, but the remote user is not authenticated.
Remote and local user databases (same username)	Enabled	Disabled	Local user is authenticated, but the remote user is not authenticated.

¹ This works only when there is FM/DM concept from NMS server where it syncs user credentials automatically to the CN127 switch which results in expected SNMP walk output. Otherwise, the user credentials will not sync to switch and should be done manually using hidden CLI on switch.

10.2.3.5 Group-Based SNMP Access

SNMP access rights are organized by groups. Each group in SNMP is similar to a role through the CLI. Each group is defined with read access or read-write access.

You can begin communicating with the agent once your username is created, your roles are set up by your administrator, and you are added to the roles.

10.2.4 SNMP and Embedded Event Manager

The Embedded Event Manager (EEM) feature monitors events, including SNMP MIB objects, and triggers an action based on these events. One of the actions could be to send an SNMP notification. EEM sends the cEventManagerPolicyEvent of INSPUR-EMBEDDED-EVENT-MGR-MIB as the SNMP notification.

10.2.5 Multiple Instance Support

A device can support multiple instances of a logical network entity, such as protocol instances or virtual routing and forwarding (VRF) instances. Most existing MIBs cannot distinguish between these multiple logical network entities. For example, the original OSPF-MIB assumes a single protocol instance on a device, but you can now configure multiple OSPF instances on a device.

SNMPv3 uses contexts to distinguish between these multiple instances. An SNMP context is a collection of management information that you can access through the SNMP agent. A device can support multiple contexts for different logical network entities. An SNMP context allows the SNMP manager to access one of the multiple instances of a MIB module supported on the device for the different logical network entities.

Inspur INOS supports the INSPUR-CONTEXT-MAPPING-MIB to map between SNMP contexts and logical network entities. You can associate an SNMP context to a VRF, protocol instance, or topology.

SNMPv3 supports contexts with the contextName field of the SNMPv3 PDU. You can map this contextName field to a particular protocol instance or VRF.

For SNMPv2c, you can map the SNMP community to a context using the `snmpCommunityContextName` MIB object in the SNMP-COMMUNITY-MIB (RFC 3584). You can then map this `snmpCommunityContextName` to a particular protocol instance or VRF using the

INSPUR-CONTEXT-MAPPING-MIB or the CLI.

10.2.6 High Availability for SNMP

Inspur INOS supports stateless restarts for SNMP. After a reboot or supervisor switchover, Inspur INOS applies the running configuration.

10.2.7 Virtualization Support for SNMP

Inspur INOS supports one instance of the SNMP per virtual device context (VDC). By default, Inspur INOS places you in the default VDC. For more information, see the Inspur CN12700 Series INOS Virtual Device Context Configuration Guide.

SNMP supports multiple MIB module instances and maps them to logical network entities. For more information, see the “Multiple Instance Support” section.

SNMP is also VRF aware. You can configure SNMP to use a particular VRF to reach the SNMP notification host receiver. You can also configure SNMP to filter notifications to an SNMP host receiver based on the VRF where the notification occurred. For more information, see the “Configuring SNMP Notification Receivers with VRFs” section.

10.3 Licensing Requirements for SNMP

Product	License Requirement
Inspur INOS	SNMP requires no license. Any feature not included in a license package is bundled with the INOS image and is provided at no extra charge to you. For a complete explanation of the Inspur INOS licensing scheme, see the <i>Inspur INOS Licensing Guide</i> .

10.4 Prerequisites for SNMP

If you configure VDCs, install the appropriate license and enter the desired VDC. See the Inspur CN12700 Series INOS Virtual Device Context Configuration Guide for configuration information and the Inspur INOS Licensing Guide for licensing information.

10.5 Guidelines and Limitations for SNMP

SNMP has the following configuration guidelines and limitations:

Access control list (ACLs) can be applied only to local SNMPv3 users configured on the switch. ACLs cannot be applied to remote SNMPv3 users stored on Authentication, Authorization, and Accounting (AAA) servers.

10.6 Default Settings for SNMP

The following table lists the default settings for SNMP parameters.

Parameters	Default
License notifications	Enabled

10.7 Configuring SNMP

10.7.1 Configuring SNMP Users

You can configure a user for SNMP.

Procedure

	Command or Action	Purpose
Step 1	configure terminal Example: switch# configure terminal switch(config)#	Enters global configuration mode.
Step 2	snmp-server user <i>name</i> [auth {md5 sha} <i>passphrase</i> [auto] [priv [aes-128] <i>passphrase</i>] [engineID <i>id</i>] [localizedkey]] Example: switch(config)# snmp-server user Admin auth sha abcd1234 priv abcdefgh	Configures an SNMP user with authentication and privacy parameters. The passphrase can be any case-sensitive, alphanumeric string up to 64 characters. If you use the localizedkey keyword, the passphrase can be any case-sensitive, alphanumeric string up to 130 characters. The engineID format is a 12-digit, colon-separated decimal number.
Step 3	(Optional) show snmp user Example: switch(config) # show snmp user	Displays information about one or more SNMP users.
Step 4	(Optional) copy running-config startup-config Example: switch(config)# copy running-config startup-config	Copies the running configuration to the startup configuration.

10.7.2 Enforcing SNMP Message Encryption

You can configure SNMP to require authentication or encryption for incoming requests. By default, the SNMP agent accepts SNMPv3 messages without authentication and encryption. When you enforce privacy, Inspur INOS responds with an authorization error for any SNMPv3 PDU request using a security level parameter of either noAuthNoPriv or authNoPriv.

Procedure

	Command or Action	Purpose
Step 1	configure terminal Example: switch# configure terminal switch(config)#	Enters global configuration mode.
Step 2	snmp-server user <i>name</i> enforcePriv Example: switch(config)# snmp-server user Admin enforcePriv	Enforces SNMP message encryption for this user.
Step 3	snmp-server globalEnforcePriv Example: switch(config)# snmp-server globalEnforcePriv	Enforces SNMP message encryption for all users.
Step 4	(Optional) copy running-config startup-config Example:	Copies the running configuration to the startup configuration.

```
switch(config)# copy running-config startup-config
```

10.7.3 Assigning SNMPv3 Users to Multiple Roles

After you configure an SNMP user, you can assign multiple roles for the user.

Procedure

	Command or Action	Purpose
Step 1	configure terminal Example: switch# configure terminal switch(config)#	Enters global configuration mode.
Step 2	snmp-server user <i>name group</i> Example: switch(config)# snmp-server user Admin superuser	Associates this SNMP user with the configured user role.
Step 3	(Optional) copy running-config startup-config Example: switch(config)# copy running-config startup-config	Copies the running configuration to the startup configuration.

10.7.4 Creating SNMP Communities

You can create SNMP communities for SNMPv1 or SNMPv2c.

Procedure

	Command or Action	Purpose
Step 1	configure terminal Example: switch# configure terminal switch(config)#	Enters global configuration mode.
Step 2	snmp-server community <i>name {group group ro rw}</i> Example: switch(config)# snmp-server community public ro	Creates an SNMP community string.
Step 3	(Optional) copy running-config startup-config Example: switch(config)# copy running-config startup-config	Copies the running configuration to the startup configuration.

10.7.5 Filtering SNMP Requests

You can assign an access control list (ACL) to an SNMPv3 user or SNMPv3 community to filter incoming SNMP requests. If the assigned ACL allows the incoming request packet, SNMP processes the request. If the ACL denies the request, SNMP drops the request and sends a system message.

Create the ACL with the following parameters:

- Source IP address

- Destination IP address
- Source port
- Destination port
- Protocol (UDP or TCP)

Procedure

	Command or Action	Purpose
Step 1	configure terminal Example: switch# configure terminal switch(config)#	Enters global configuration mode.
Step 2	snmp-server user <i>name</i> [use-ipv4acl <i>ipv4acl-name</i>] [use-ipv6acl <i>ipv6acl-name</i>] Example: switch(config)# snmp-server community public use-ipv4acl myacl	Assigns an IPv4 or IPv6 ACL to an SNMPv3 user to filter SNMP requests. Note The AAA server must support the creation of SNMPv3 users.
Step 3	snmp-server community <i>name</i> [use-ipv4acl <i>ipv4acl-name</i>] [use-ipv6acl <i>ipv6acl-name</i>] Example: switch(config)# snmp-server community public use-ipv4acl myacl	Assigns an IPv4 or IPv6 ACL to an SNMPv3 community to filter SNMP requests.
Step 4	(Optional) copy running-config startup-config Example: switch(config)# copy running-config startup-config	Copies the running configuration to the startup configuration.

10.7.6 Authenticating SNMPv3 Users Based on Location

You can authenticate local or remote SNMPv3 users based on their location.

Use the following command in global configuration mode to enable AAA exclusive behavior in SNMPv3 servers:

Command	Purpose
snmp-server aaa exclusive-behavior enable	Enables the AAA exclusive behavior in SNMPv3 servers to authenticate users based on location. Depending on the location of the user and whether the AAA server is enabled, the exclusive behavior is as follows: <ul style="list-style-type: none"> • If the user is a local user and the AAA server is enabled, queries for the user will fail with an “Unknown user” message. • If the user is a remote AAA user and the AAA server is disabled, queries for the user will fail with an “Unknown user” message. • If the user is both a local user and a remote AAA user and the AAA server is enabled, the queries with remote credentials will succeed, and queries with local credentials will fail with an “Incorrect password” message. If the AAA server is disabled, queries with local remote credentials will succeed, and queries with remote credentials will fail with an “Incorrect password” message.

10.7.7 Configuring SNMP Notification Receivers

You can configure Inspur INOS to generate SNMP notifications to multiple host receivers.

Procedure

	Command or Action	Purpose
Step 1	configure terminal Example: switch# configure terminal switch(config)#	Enters global configuration mode.
Step 2	snmp-server host ip-address traps version 1 <i>community</i> [<i>udp_port number</i>] Example: switch(config)# snmp-server host 192.0.2.1 traps version 1 public	Configures a host receiver for SNMPv1 traps. The <i>ip-address</i> can be an IPv4 or IPv6 address. The <i>community</i> can be any alphanumeric string up to 255 characters. The UDP port number range is from 0 to 65535.
Step 3	snmp-server host ip-address {traps informs} version 2c community [udp_port number] Example: switch(config)# snmp-server host 192.0.2.1 informs version 2c public	Configures a host receiver for SNMPv2c traps or informs. The <i>ip-address</i> can be an IPv4 or IPv6 address. The <i>community</i> can be any alphanumeric string up to 255 characters. The UDP port number range is from 0 to 65535.
Step 4	snmp-server host ip-address {traps informs} version 3 {auth noauth priv} username [udp_port number] Example: switch(config)# snmp-server host 192.0.2.1 informs version 3 auth NMS	Configures a host receiver for SNMPv3 traps or informs. The <i>ip-address</i> can be an IPv4 or IPv6 address. The <i>username</i> can be any alphanumeric string up to 255 characters. The UDP port number range is from 0 to 65535. Note The SNMP manager must know the user credentials (authKey/PrivKey) based on the SNMP engine ID of the Inspur INOS device to authenticate and decrypt the SNMPv3 messages.
Step 5	(Optional) copy running-config startup-config Example: switch(config)# copy running-config startup-config	Copies the running configuration to the startup configuration.

10.7.8 Configuring a Source Interface for SNMP Notifications

You can configure SNMP to use the IP address of an interface as the source IP address for notifications. When a notification is generated, its source IP address is based on the IP address of this configured interface.

You can configure a source interface as follows:

- All notifications sent to all SNMP notification receivers.
- All notifications sent to a specific SNMP notification receiver. This configuration overrides the global source interface configuration.

Procedure

	Command or Action	Purpose
Step 1	configure terminal	Enters global configuration mode.

	Command or Action	Purpose
	Example: switch# configure terminal switch(config)#	
Step 2	snmp-server host <i>ip-address</i> source-interface <i>if-type if-number</i> [udp_port <i>number</i>] Example: switch(config)# snmp-server host 192.0.2.1 source-interface ethernet 2/1	Configures a host receiver for SNMPv2c traps or informs. The <i>ip-address</i> can be an IPv4 or IPv6 address. Use ? to determine the supported interface types. The UDP port number range is from 0 to 65535. This configuration overrides the global source interface configuration.
Step 3	snmp-server source-interface { traps informs } <i>if-type if-number</i> Example: switch(config)# snmp-server source-interface traps ethernet 2/1	Configures a source interface for sending out SNMPv2c traps or informs. Use ? to determine the supported interface types.
Step 4	show snmp source-interface Example: switch(config)# show snmp source-interface	Displays information about configured source interfaces.

10.7.9 Configuring the Notification Target User

You must configure a notification target user on the device to send SNMPv3 inform notifications to a notification host receiver.

Inspur INOS uses the credentials of the notification target user to encrypt the SNMPv3 inform notification messages to the configured notification host receiver.

Procedure

	Command or Action	Purpose
Step 1	configure terminal Example: switch# configure terminal switch(config)#	Enters global configuration mode.
Step 2	snmp-server user <i>name</i> [auth { md5 sha } <i>passphrase</i> [auto] [priv [aes-128] <i>passphrase</i>] [engineID <i>id</i>] Example: switch(config)# snmp-server user NMS auth sha abcd1234 priv abcdefgh engineID 00:00:00:63:00:01:00:10:20:15:10:03	Configures the notification target user with the specified engine ID for the notification host receiver. The engine ID format is a 12-digit colon-separated decimal number.
Step 3	(Optional) copy running-config startup-config Example: switch(config)# copy running-config startup-config	Copies the running configuration to the startup configuration.

10.7.10 Configuring SNMP Notification Receivers with VRFs

SNMP adds entries into the cExtSnmptargetVrfTable of the INSPUR-SNMP-TARGET-EXT-MIB when you configure the VRF reachability and filtering options for an SNMP notification receiver.

You can configure Inspur INOS to use a configured VRF to reach the host receiver or to filter notifications based on the VRF in which the notification occurred.

Procedure

	Command or Action	Purpose
Step 1	configure terminal Example: switch# configure terminal switch(config)#	Enters global configuration mode.
Step 2	[no] snmp-server host ip-address use-vrf vrf-name [udp_port number] Example: switch(config)# snmp-server host 192.0.2.1 use-vrf Blue	Configures SNMP to use the selected VRF to communicate with the host receiver. The <i>ip-address</i> can be an IPv4 or IPv6 address. The VRF name can be any alphanumeric string up to 255 characters. The UDP port number range is from 0 to 65535. This command adds an entry into the ExtSnmpTargetVrfTable of the INSPUR-SNMP-TARGET-EXT-MB. The no form of this command removes the VRF reachability information for the configured host and removes the entry from the ExtSnmpTargetVrfTable of the INSPUR-SNMP-TARGET-EXT-MB. Note This command does not remove the host configuration.
Step 3	[no] snmp-server host ip-address filter-vrf vrf-name [udp_port number] Example: switch(config)# snmp-server host 192.0.2.1 filter-vrf Red	Filters notifications to the notification host receiver based on the configured VRF. The <i>ip-address</i> can be an IPv4 or IPv6 address. The VRF name can be any alphanumeric string up to 255 characters. The UDP port number range is from 0 to 65535. This command adds an entry into the ExtSnmpTargetVrfTable of the INSPUR-SNMP-TARGET-EXT-MB. The no form of this command removes the VRF filter information for the configured host and removes the entry from the ExtSnmpTargetVrfTable of the INSPUR-SNMP-TARGET-EXT-MB. Note This command does not remove the host configuration.
Step 4	(Optional) copy running-config startup-config Example: switch(config)# copy running-config startup-config	Copies the running configuration to the startup configuration.

10.7.11 Configuring SNMP to Send Traps Using an Inband Port

You can configure SNMP to send traps using an inband port. To do so, you must configure the source interface (at the global or host level) and the VRF used to send the traps.

Procedure

	Command or Action	Purpose
Step 1	configure terminal Example: switch# configure terminal switch(config)#	Enters global configuration mode.
Step 2	snmp-server source-interface traps <i>if-type if-number</i> Example: switch(config)# snmp-server source-interface traps ethernet 1/2	Globally configures a source interface for sending out SNMP traps. Use ? to determine the supported interface types. You can configure the source interface at the global level or at a host level. When the source interface is configured globally, any new host configuration uses the global configuration to send the traps. Note To configure a source interface at the host level, use the snmp-server host ip-address source-interface if-type if-number command.
Step 3	(Optional) show snmp source-interface Example: switch(config)# show snmp source-interface	Displays information about configured source interfaces.
Step 4	snmp-server host ip-address use-vrf <i>vrf-name [udp_port number]</i> Example: switch(config)# snmp-server host 171.71.48.164 use-vrf default	Configures SNMP to use the selected VRF to communicate with the host receiver. The <i>ip-address</i> can be an IPv4 or IPv6 address. The VRF name can be any alphanumeric string up to 255 characters. The UDP port number range is from 0 to 65535. This command adds an entry into the ExtSnmpTargetVrfTable of the INSPUR-SNMP-TARGET-EXT-MB. Note By default, SNMP sends the traps using the management VRF. If you do not want to use the management VRF, you must use this command to specify the desired VRF.
Step 5	(Optional) show snmp host Example: switch(config)# show snmp host	Displays information about configured SNMP hosts.
Step 6	(Optional) copy running-config startup-config Example: switch(config)# copy running-config startup-config	Copies the running configuration to the startup configuration.

10.7.12 Enabling SNMP Notifications

You can enable or disable notifications. If you do not specify a notification name, Inspur INOS enables all notifications.

The following table lists the commands that enable the notifications for Inspur INOS MIBs.

Table 22 Enabling SNMP Notifications

MIB	Related Commands
All notifications	snmp-server enable traps
INSPUR-AAA-SERVER-MIB	snmp-server enable traps aaa snmp-server enable traps aaa server-state-change
INSPUR-BGP4-MIB	snmp-server enable traps bgp
INSPUR-BGP-MIBv2	snmp-server enable traps bgp cbgp2
INSPUR-STP-BRIDGE-MIB	snmp-server enable traps bridge snmp-server enable traps bridge newroot snmp-server enable traps bridge topologychange
INSPUR-CALLHOME-MIB	snmp-server enable traps callhome snmp-server enable traps callhome event-notify snmp-server enable traps callhome smtp-send-fail
INSPUR-CFS-MIB	snmp-server enable traps cfs snmp-server enable traps cfs merge-failure snmp-server enable traps cfs state-change-notif
INSPUR-CONFIG-MAN-MIB	snmp-server enable traps config snmp-server enable traps config ccmCLIRunningConfigChanged
INSPUR-EIGRP-MIB	snmp-server enable traps eigrp [tag]
ENTITY-MIB, INSPUR-ENTITY-SENSOR-MIB	snmp-server enable traps entity snmp-server enable traps entity entity_fan_status_change snmp-server enable traps entity entity_mib_change snmp-server enable traps entity entity_module_inserted snmp-server enable traps entity entity_module_removed snmp-server enable traps entity entity_module_status_change snmp-server enable traps entity entity_power_out_change snmp-server enable traps entity entity_power_status_change snmp-server enable traps entity entity_unrecognised_module
INSPUR-FEATURE-CONTROL-MIB	snmp-server enable traps feature-control snmp-server enable traps feature-control FeatureOpStatusChange
INSPUR-HSRP-MIB	snmp-server enable traps hsrp snmp-server enable traps hsrp state-change
INSPUR-LICENSE-MGR-MIB	snmp-server enable traps license snmp-server enable traps license notify-license-expiry snmp-server enable traps license notify-license-expiry- warning snmp-server enable traps license notify-licensefile-missing snmp-server enable traps license notify-no-license-for- feature
INSPUR-INTERFACE-XCVR MONITOR-MIB	snmp-server enable traps link Inspur-xcvr-mon-status-chg
IF-MIB	snmp-server enable traps link snmp-server enable traps link IETF-extended-linkDown snmp-server enable traps link IETF-extended-linkUp snmp-server enable traps link Inspur-extended-linkDown

MIB	Related Commands
	snmp-server enable traps link Inspur-extended-linkUp snmp-server enable traps link linkDown snmp-server enable traps link Up
OSPF-MIB, OSPF-TRAP-MIB	snmp-server enable traps ospf <i>[tag]</i> snmp-server enable traps ospf lsa snmp-server enable traps ospf rate-limit rate
INSPUR-PORT-SECURITY-MIB	snmp-server enable traps port-security snmp-server enable traps port-security access-secure-mac-violation snmp-server enable traps port-security trunk-secure-mac-violation
INSPUR-RF-MIB	snmp-server enable traps rf snmp-server enable traps rf redundancy_framework
INSPUR-RMON-MIB	snmp-server enable traps rmon snmp-server enable traps rmon fallingAlarm snmp-server enable traps rmon hcFallingAlarm snmp-server enable traps rmon hcRisingAlarm snmp-server enable traps rmon risingAlarm
SNMPv2-MIB	snmp-server enable traps snmp snmp-server enable traps snmp authentication
INSPUR-STPX-MIB	snmp-server enable traps stpx snmp-server enable traps stpx inconsistency snmp-server enable traps stpx loop-inconsistency snmp-server enable traps stpx root-inconsistency
INSPUR-SYSTEM-EXT-MIB	snmp-server enable traps sysmgr snmp-server enable traps sysmgr cseFailSwCoreNotifyExtended
UPGRADE-MIB	snmp-server enable traps upgrade snmp-server enable traps upgrade UpgradeJobStatusNotify snmp-server enable traps upgrade UpgradeOpNotifyOnCompletion
ZONE-MIB	zone zone default-zone-behavior-changes zone merge-failure zone merge-success zone request-reject1 zone unsupp-mem

Use the following commands in global configuration mode to enable the specified notification:

Command	Purpose
snmp-server enable traps	Enables all SNMP notifications.
snmp-server enable traps aaa [server-state-change]	Enables the AAA SNMP notifications. Optionally, enables the following specific notifications: <ul style="list-style-type: none"> server-state-change—Enables AAA server state-change notifications.
snmp-server enable traps bgp [cbgp2]	Enables INSPUR-BGP4-MIB SNMP notifications. Optionally, enables the following specific notifications:

Command	Purpose
	<ul style="list-style-type: none"> • bgp cbgp2—Enables INSPUR-BGP4-MIBv2 SNMP notifications.
snmp-server enable traps bridge [newroot] [topologychange]	<p>Enables STP bridge SNMP notifications. Optionally, enables the following specific notifications:</p> <ul style="list-style-type: none"> • newroot—Enables STP new root bridge notifications. • topologychange—Enables STP bridge topology-change notifications.
snmp-server enable traps callhome [event-notify] [smtp-send-fail]	<p>Enables Call Home notifications. Optionally, enables the following specific notifications:</p> <ul style="list-style-type: none"> • event-notify—Enables Call Home external event notifications. • smtp-send-fail—Enables Simple Mail Transfer Protocol (SMTP) message send fail notifications.
snmp-server enable traps cfs [merge-failure] [state-change-notif]	<p>Enables Inspur Fabric Services (CFS) notifications. Optionally, enables the following specific notifications:</p> <ul style="list-style-type: none"> • merge-failure—Enables CFS merge-failure notifications. • state-change-notif—Enables CFS state-change notifications.
snmp-server enable traps config [ccmCLIRunningConfigChanged]	<p>Enables SNMP notifications for configuration changes.</p> <ul style="list-style-type: none"> • ccmCLIRunningConfigChanged—Enables SNMP notifications for configuration changes in the running or startup configuration.
snmp-server enable traps eigrp [<i>tag</i>]	Enables INSPUR-EIGRP-MIB SNMP notifications.
snmp-server enable traps entity [entity_fan_status_change] [entity_mib_change] [entity_module_inserted] [entity_module_removed] [entity_module_status_change] [entity_power_out_change] [entity_power_status_change] [entity_unrecognised_module]	<p>Enables ENTITY-MIB SNMP notifications. Optionally, enables the following specific notifications:</p> <ul style="list-style-type: none"> • entity_fan_status_change—Enables entity fan status-change notifications. • entity_mib_change—Enables entity MIB change notifications. • entity_module_inserted—Enables entity module inserted notifications. • entity_module_removed—Enables entity module removed notifications. • entity_module_status_change—Enables entity module status-change notifications. • entity_power_out_change—Enables entity power-out change notifications. • entity_power_status_change—Enables entity power status-change notifications. • entity_unrecognised_module—Enables entity unrecognized module notifications.
snmp-server enable traps feature-control [FeatureOpStatusChange]	<p>Enables feature-control SNMP notifications. Optionally, enables the following specific notifications:</p> <ul style="list-style-type: none"> • FeatureOpStatusChange—Enables feature operation status-change notifications.
snmp-server enable traps hsrp [state-change]	Enables INSPUR-HSRP-MIB SNMP

Command	Purpose
	notifications. Optionally, enables the following specific notifications: <ul style="list-style-type: none"> • state-change—Enables HSRP state-change notifications.
snmp-server enable traps license [notify-license-expiry] [notify-license-expiry-warning] [notify-licensefile-missing] [notify-no-license-for-feature]	Enables ENTITY-MIB SNMP notifications. Optionally, enables the following specific notifications: <ul style="list-style-type: none"> • notify-license-expiry—Enables license expiry notifications. • notify-license-expiry-warning—Enables license expiry warning notifications. • notify-licensefile-missing—Enables license file-missing notifications. • notify-no-license-for-feature—Enables no-license-installed-for-feature notifications.
snmp-server enable traps link [IETF-extended-linkDown] [IETF-extended-linkUp] [Inspur-extended-linkDown] [Inspur-extended-linkUp] [linkDown] [linkUp]	Enables IF-MIB link notifications. Optionally, enables the following specific notifications: <ul style="list-style-type: none"> • IETF-extended-linkDown—Enables Internet Engineering Task Force (IETF) extended link state down notifications. • IETF-extended-linkUp—Enables Internet Engineering Task Force (IETF) extended link state up notifications. • Inspur-extended-linkDown—Enables Inspur extended link state down notifications. • Inspur-extended-linkUp—Enables Inspur extended link state up notifications. • linkDown—Enables IETF link state down notifications. • linkUp—Enables IETF link state up notifications.
snmp-server enable traps ospf [<i>tag</i>] [<i>lsa</i>]	Enables Open Shortest Path First (OSPF) notifications. Optionally, enables the following specific notifications: <ul style="list-style-type: none"> • lsa—Enables OSPF link state advertisement (LSA) notifications.
snmp-server enable traps port-security [access-secure-mac-violation] [trunk-secure-mac-violation]	Enables port-security SNMP notifications. Optionally, enables the following specific notifications: <ul style="list-style-type: none"> • access-secure-mac-violation—Enables secure machine access control (MAC) violation notifications. • trunk-secure-mac-violation—Enables virtual LAN (VLAN) secure MAC violation notifications.
snmp-server enable traps rf [redundancy-framework]	Enables redundancy framework (RF) SNMP notifications. Optionally, enables the following specific notifications: <ul style="list-style-type: none"> • redundancy-framework—Enables RF supervisor switchover MIB notifications.
snmp-server enable traps rmon [fallingAlarm] [hcFallingAlarm] [hcRisingAlarm] [risingAlarm]	Enables remote monitoring (RMON) SNMP notifications. Optionally, enables the following specific notifications: <ul style="list-style-type: none"> • fallingAlarm—Enables RMON falling alarm notifications. • hcFallingAlarm—Enables RMON high-capacity falling alarm notifications.

Command	Purpose
	<ul style="list-style-type: none"> • hcRisingAlarm—Enables RMON high-capacity rising alarm notifications. • risingAlarm—Enables RMON rising alarm notifications.
snmp-server enable traps snmp [authentication]	Enables general SNMP notifications. Optionally, enables the following specific notifications: <ul style="list-style-type: none"> • authentication—Enables SNMP authentication notifications.
snmp-server enable traps stpx [inconsistency] [loop-inconsistency] [root-inconsistency]	Enables remote monitoring (RMON) SNMP notifications. Optionally, enables the following specific notifications: <ul style="list-style-type: none"> • inconsistency—Enables SNMP STPX MIB inconsistency update notifications. • loop-inconsistency—Enables SNMP STPX MIB loop-inconsistency update notifications. • root-inconsistency—Enables SNMP STPX MIB root-inconsistency update notifications.
snmp-server enable traps sysmgr [cseFailSwCoreNotifyExtended]	Enables software change notifications. Optionally, enables the following specific notifications: <ul style="list-style-type: none"> • cseFailSwCoreNotifyExtended—Enables software core notifications.
snmp-server enable traps upgrade [UpgradeJobStatusNotify] [UpgradeOpNotifyOnCompletion]	Enables upgrade notifications. Optionally, enables the following specific notifications: <ul style="list-style-type: none"> • UpgradeJobStatusNotify—Enables upgrade job status notifications. • UpgradeOpNotifyOnCompletion—Enables upgrade global status notifications.
snmp-server enable traps vtp [notifs] [vlancreate] [vlandelete]	Enables VTP notifications. Optionally, enables the following specific notifications: <ul style="list-style-type: none"> • notifs—Enables VTP notifications. • vlancreate—Enables VLAN creation notifications. • vlandelete—Enables VLAN deletion notifications.
snmp-server enable traps zone [default-zone-behavior-change] [merge-failure] [merge-success] [request-reject1] [unsupp-mem]	Enables default zone change notifications. Optionally, enables the following specific notifications: <ul style="list-style-type: none"> • default-zone-behavior-change—Enables default zone behavior change notifications. • merge-failure—Enables merge failure notifications. • merge-success—Enables merge success notifications. • request-reject1—Enables request reject notifications. • unsupp-mem—Enables unsupported member notifications.

10.7.13 Disabling Link Notifications on an Interface

You can disable linkUp and linkDown notifications on an individual interface. You can use this limit notifications on flapping interface (an interface that transitions between up and down repeatedly).

Procedure

Command or Action	Purpose
-------------------	---------

	Command or Action	Purpose
Step 1	configure terminal Example: switch# configure terminal switch(config)#	Enters global configuration mode.
Step 2	interface type slot/port Example: switch(config)# interface ethernet 2/2	Disables SNMP link-state traps for the interface. This command is enabled by default.
Step 3	no snmp trap link-status Example: switch(config-if)# no snmp trap link-status	Disables SNMP link-state traps for the interface. This command is enabled by default.
Step 4	(Optional) copy running-config startup-config Example: switch(config-if)# copy running-config startup-config	Copies the running configuration to the startup configuration.

10.7.14 Displaying SNMP ifIndex for an Interface

The SNMP ifIndex is used across multiple SNMP MIBs to link related interface information.

Procedure

	Command or Action	Purpose
Step 1	show interface snmp-ifindex Example: switch# show interface snmp-ifindex grep -i Eth12/1 Eth12/1 441974784 (0x1a580000)	Displays the persistent SNMP ifIndex value from the IF-MIB for all interfaces. Optionally, use the keyword and the grep keyword to search for a particular interface in the output.

10.7.15 Enabling a One-Time Authentication for SNMP over TCP

You can enable a one-time authentication for SNMP over a TCP session.

Procedure

	Command or Action	Purpose
Step 1	configure terminal Example: switch# configure terminal switch(config)#	Enters global configuration mode.
Step 2	snmp-server tcp-session [auth] Example: switch(config)# snmp-server tcp-session	Enables a one-time authentication for SNMP over a TCP session. The default is disabled.
Step 3	(Optional) copy running-config startup-config Example: switch(config)# copy running-config startup-config	Copies the running configuration to the startup configuration.

10.7.16 Assigning SNMP Device Contact and Location Information

You can assign the device contact information, which is limited to 32 characters (without spaces) and the device location.

Procedure

	Command or Action	Purpose
Step 1	configure terminal Example: switch# configure terminal switch(config)#	Enters global configuration mode.
Step 2	snmp-server contact <i>name</i> Example: switch(config)# snmp-server contact Admin	Configures sysContact, which is the SNMP contact name.
Step 3	snmp-server location <i>name</i> Example: switch(config)# snmp-server location Lab-7	Configures sysLocation, which is the SNMP location.
Step 4	(Optional) show snmp Example: switch(config)# show snmp	Displays information about one or more destination profiles.
Step 5	(Optional) copy running-config startup-config Example: switch(config)# copy running-config startup-config	Copies the running configuration to the startup configuration.

10.7.17 Configuring the Context to Network Entity Mapping

You can configure an SNMP context to map to a logical network entity, such as a protocol instance or VRF.

Before you begin

Determine the logical network entity instance. For more information on VRFs and protocol instances, see the Inspur CN12700 Series INOS Unicast Routing Configuration Guide or the Inspur CN12700 Series INOS Multicast Routing Configuration Guide.

Procedure

	Command or Action	Purpose
Step 1	configure terminal Example: switch# configure terminal switch(config)#	Enters global configuration mode.
Step 2	[no] snmp-server context <i>context-name</i> [instance <i>instance-name</i>] [vrf <i>vrf-name</i>] [topology <i>topology-name</i>] Example: switch(config)# snmp-server context public1 vrf red	Maps an SNMP context to a protocol instance, VRF, or topology. Before Release 6.2(2), the names can be any alphanumeric string up to 32 characters. In Release 6.2(2) and later releases, the string can include non alphanumeric characters. However, the best practice is to use alphanumeric characters only. The no option deletes the mapping between an SNMP context and a protocol instance, VRF, or topology.

	Command or Action	Purpose
		Note Do not enter an instance, VRF, or topology to delete a context mapping. If you use the instance, VRF, or topology keywords, you configure a mapping between the context and a zero-length string.
Step 3	(Optional) snmp-server mib community-map <i>community-name context context-name</i> Example: switch(config)# snmp-server mib community-map public1	Maps an SNMPv2c community to an SNMP context. The names can be any alphanumeric string up to 32 characters.
Step 4	(Optional) show snmp context Example: switch(config)# show snmp context	Displays information about one or more SNMP contexts.
Step 5	(Optional) copy running-config startup-config Example: switch(config)# copy running-config startup-config	Copies the running configuration to the startup configuration.

10.7.18 Disabling SNMP

You can disable SNMP on the device.

Procedure

	Command or Action	Purpose
Step 1	configure terminal Example: switch# configure terminal switch(config)#	Enters global configuration mode.
Step 2	no snmp-server protocol enable Example: switch(config)# no snmp-server protocol enable	Disables SNMP. SNMP is enabled by default.

10.7.19 Managing the SNMP Server Counter Cache Update Timer

You can modify how long, in seconds Inspur INOS holds the cache port state.

Procedure

	Command or Action	Purpose
Step 1	configure terminal Example: switch# configure terminal switch(config)#	Enters global configuration mode.
Step 2	snmp-server counter cache-timeout <i>seconds</i> Example: switch(config)# snmp-server counter cache-timeout 1800	Defines how long in seconds, the port states are held in the local cache. The counter cache is enabled by default, and the default cache timeout value is 10 seconds. When disabled, the default

	Command or Action	Purpose
		value for the SNMP cache expiry timeout is 140 seconds. The range is 1-3600. For end of row (EoR) switching - The range is from 10 to 3600.
Step 3	(Optional) show running-config snmp all Example: switch(config)# show running-config snmp all	Displays the configured SNMP-server counter cache update timeout value.
Step 4	no snmp-server counter cache enable Example: switch(config)# no snmp-server counter cache enable	Disables the counter cache update. When the counter cache update is disabled, the value set in the timeout parameter determines length of time the port states are held the counter cache.

10.7.20 Modifying the AAA Synchronization Time

You can modify how long Inspur INOS holds the synchronized user configuration.

Procedure

	Command or Action	Purpose
Step 1	configure terminal Example: switch# configure terminal switch(config)#	Enters global configuration mode.
Step 2	snmp-server aaa-user cache-timeout <i>seconds</i> Example: switch(config)# snmp-server aaa-user cache-timeout 1200	Configures how long the AAA synchronized user configuration stays in the local cache. The range is from 1 to 86400 seconds. The default is 3600.
Step 3	(Optional) copy running-config startup-config Example: switch(config)# copy running-config startup-config	Copies the running configuration to the startup configuration.

10.8 Verifying SNMP Configuration

To display SNMP configuration information, perform one of the following tasks:

Command	Purpose
show interface snmp-ifindex	Displays the SNMP ifIndex value for all interfaces (from IF-MIB).
show running-config snmp [all]	Displays the SNMP running configuration.
show snmp	Displays the SNMP status.
show snmp community	Displays the SNMP community strings.
show snmp context	Displays the SNMP context mapping.
show snmp engineID	Displays the SNMP engineID.
show snmp group	Displays SNMP roles.
show snmp host	Displays information about configured SNMP hosts.
show snmp session	Displays SNMP sessions.
show snmp source-interface	Displays information about configured source interfaces.
show snmp trap	Displays the SNMP notifications enabled or disabled.
show snmp user	Displays SNMPv3 users.

10.9 Configuration Examples for SNMP

This example shows how to configure Inspur INOS to send the Inspur linkUp or Down notifications to one notification host receiver using the Blue VRF and defines two SNMP users, Admin and NMS:

```

configure terminal
snmp-server contact Admin@company.com
snmp-server user Admin auth sha abcd1234 priv abcdefgh
snmp-server user NMS auth sha abcd1234 priv abcdefgh engineID
00:00:00:63:00:01:00:22:32:15:10:03
snmp-server host 192.0.2.1 informs version 3 auth NMS
snmp-server host 192.0.2.1 use-vrf Blue
snmp-server enable traps link Inspur

```

This example shows how to configure SNMP to send traps using an inband port configured at the host level:

```

switch# configure terminal
Enter configuration commands, one per line. End with CNTL/Z.
switch(config)# snmp-server host 171.71.48.164 version 2c public
switch(config)# snmp-server host 171.71.48.164 source-interface ethernet 1/2
switch(config)# show snmp host
-----
Host Port Version Level Type SecName
-----
171.71.48.164 162 v2c noauth trap public
Source interface: Ethernet 1/2
-----
switch(config)# snmp-server host 171.71.48.164 use-vrf default
switch(config)# show snmp host
-----
Host Port Version Level Type SecName
-----
171.71.48.164 162 v2c noauth trap public
Use VRF: default
Source interface: Ethernet 1/2
-----

```

This example shows how to configure SNMP to send traps using a globally configured inband port:

```

switch# configure terminal
Enter configuration commands, one per line. End with CNTL/Z.
switch(config)# snmp-server source-interface traps ethernet 1/2
switch(config)# show snmp source-interface
-----
Notification source-interface
-----
trap Ethernet1/2
inform -
-----
switch(config)# snmp-server host 171.71.48.164 use_vrf default
switch(config)# show snmp host
-----
Host Port Version Level Type SecName
-----
171.71.48.164 162 v2c noauth trap public
Use VRF: default
Source interface: Ethernet 1/2
-----

```

This example shows how to map VRF red to the SNMPv2c public community string:

```
switch# configure terminal
Enter configuration commands, one per line. End with CNTL/Z.
switch(config)# vrf context red
switch(config-vrf)# exit
switch(config)# snmp-server context public1 vrf red
switch(config)# snmp-server mib community-map public context public1
```

This example shows how to map OSPF instance Enterprise to the same SNMPv2c public community string:

```
switch# configure terminal
Enter configuration commands, one per line. End with CNTL/Z.
switch(config)# feature ospf
switch(config)# router ospf Enterprise
switch(config-router)# exit
switch(config)# snmp-server context public1 instance Enterprise
switch(config)# snmp-server mib community-map public context public1
```

This example shows how to configure both IPv4 and IPv6 ACLs with the SNMPv3 “newstring” community:

```
switch# configure terminal
switch(config)# snmp-server community newstring use-ipv4acl myacl use-ipv6acl
myacl1
switch(config)# show running-config snmp
version 6.2(2)
snmp-server aaa exclusive-behavior enable
snmp-server user admin network-admin auth md5 0x2f2429f3c9b21f1adbae8acc7783e355
priv 0x2f2429f3c9b21f1adbae8acc7783e355 localizedkey
rmon event 1 log trap public description FATAL(1) owner PMON@FATAL
rmon event 2 log trap public description CRITICAL(2) owner PMON@CRITICAL
rmon event 3 log trap public description ERROR(3) owner PMON@ERROR
rmon event 4 log trap public description WARNING(4) owner PMON@WARNING
rmon event 5 log trap public description INFORMATION(5) owner PMON@INFO
snmp-server community newstring group network-operator
snmp-server community newstring use-ipv4acl myacl use-ipv6acl myacl1
switch# show snmp community
Community Group / Access context acl_filter
newstring network-operator ipv4:myacl ipv6:myacl1
switch#
```

10.10 Feature History for SNMP

The table below summarizes the new and changed features for this document and shows the releases in which each feature is supported. Your software release might not support all the features in this document. For the latest caveats and feature information, the release notes for your software release.

Table 23 Feature History for SNMP

Feature Name	Releases	Feature Information
SNMPv3 user and communities	6.2(2)	Added the ability to apply both IPv4 and IPv6 ACLs to the same SNMPv3 user or SNMPv3 community.
SNMPv3	6.2(2)	Added support for AAA exclusive behavior in SNMPv3 servers to authenticate users based on location.
SNMP notifications	5.0(2)	Updated the snmp-server enable traps commands.
IPv6 support	4.2(1)	Supports configuring IPv6 SNMP hosts.
Filter SNMP requests by community using an ACL	4.2(1)	Assigns an ACL to an SNMP community to filter SNMP requests.
Use interfaces for SNMP	4.2(1)	Added support to designate an interface to act as the source

notification receivers		interface for SNMP notifications.
SNMP AAA synchronization	4.0(3)	Added the ability to modify the synchronized user configuration timeout.
SNMP protocol	4.0(3)	Added the ability to disable the SNMP protocol.

CHAPTER 11 Configuring RMON

This chapter describes how to configure the remote monitoring (RMON) feature on Inspur INOS devices. This chapter contains the following sections:

- Finding Feature Information
- About RMON
- Licensing Requirements for RMON
- Prerequisites for RMON
- Guidelines and Limitations for RMON
- Default Settings for RMON
- Configuring RMON
- Verifying the RMON Configuration
- Configuration Examples for RMON
- Additional References
- Feature History for RMON

11.1 Finding Feature Information

Your software release might not support all the features documented in this module. For the latest caveats and feature information, the release notes for your software release. To find information about the features documented in this module, and to see a list of the releases in which each feature is supported, see the "New and Changed Information" chapter or the Feature History table in this chapter.

11.2 About RMON

RMON is a Simple Network Management Protocol (SNMP) Internet Engineering Task Force (IETF) standard monitoring specification that allows various network agents and console systems to exchange network monitoring data. Inspur INOS supports RMON alarms, events, and logs to monitor Inspur INOS devices.

An RMON alarm monitors a specific management information base (MIB) object for a specified interval, triggers an alarm at a specified threshold value (threshold), and resets the alarm at another threshold value. You can use alarms with RMON events to generate a log entry or an SNMP notification when the RMON alarm triggers.

RMON is enabled by default, but no alarms are configured in Inspur INOS. You can configure RMON alarms by using the CLI or an SNMP-compatible network management station.

11.2.1 RMON Alarms

You can set an alarm on any MIB object that resolves into an SNMP INTEGER type. The specified object must be an existing SNMP MIB object in standard dot notation (for example, 1.3.6.1.2.1.2.2.1.14 represents ifInOctets.14).

When you create an alarm, you specify the following parameters:

- MIB object to monitor.
- Sampling interval—The interval that the device uses to collect a sample value of the MIB object.
- Sample type—Absolute samples take the current snapshot of the MIB object value. Delta samples take two consecutive samples and calculate the difference between them.
 - Rising threshold—The value at which the device triggers a rising alarm or resets a falling alarm.
 - Falling threshold—The value at which the device triggers a falling alarm or resets a rising alarm.
 - Events—The action that the device takes when an alarm (rising or falling) triggers.

For example, you can set a delta type rising alarm on an error counter MIB object. If the error counter delta exceeds this value, you can trigger an event that sends an SNMP notification and logs the rising alarm event. This rising alarm will not occur again until the delta sample for the error counter drops below the falling threshold.

11.2.2 RMON Events

You can associate a particular event to each RMON alarm. RMON supports the following event types:

- **SNMP notification**—Sends an SNMP risingAlarm or fallingAlarm notification when the associated alarm triggers.
- **Log**—Adds an entry in the RMON log table when the associated alarm triggers.
- **Both**—Sends an SNMP notification and adds an entry in the RMON log table when the associated alarm triggers.

You can specify a different even for a falling alarm and a rising alarm.

11.2.3 High Availability for RMON

Inspur INOS supports stateless restarts for RMON. After a reboot or supervisor switchover, Inspur INOS applies the running configuration.

11.2.4 Virtualization Support for RMON

Inspur INOS supports one instance of RMON.

RMON is virtual routing and forwarding (VRF) aware. You can configure RMON to use a particular VRF to reach the RMON SMTP server.

11.3 Licensing Requirements for RMON

Product	License Requirement
Inspur INOS	RMON requires no license. Any feature not included in a license package is bundled with the INOS image and is provided at no extra charge to you. For a complete explanation of the Inspur INOS licensing scheme, see the <i>Inspur INOS Licensing Guide</i> .

11.4 Prerequisites for RMON

If you configure VDCs, install the appropriate license and enter the desired VDC. See the Inspur CN12700 Series INOS Virtual Device Context Configuration Guide for configuration information and the Inspur INOS Licensing Guide for licensing information.

11.5 Guidelines and Limitations for RMON

RMON has the following configuration guidelines and limitations:

- You must configure an SNMP user and a notification receiver to use the SNMP notification event type.
- You can configure an RMON alarm only on a MIB object that resolves to an integer.
- When you configure an RMON alarm, the object identifier must be complete with its index so that it refers to only one object. For example, 1.3.6.1.2.1.2.2.1.14 corresponds to cpmCPUTotal5minRev, and .1 corresponds to index cpmCPUTotalIndex, which creates object identifier 1.3.6.1.2.1.2.2.1.14.1.

11.6 Default Settings for RMON

The following table lists the default settings for RMON parameters.

Parameters	Default
RMON	Enabled
Alarms	None configured

11.7 Configuring RMON

11.7.1 Configuring RMON Alarms

You can configure RMON alarms on any integer-based SNMP MIB object. You can optionally specify the following parameters:

- The event number to trigger if the rising or falling threshold exceeds the specified limit.
- The owner of the alarm.

Ensure you have configured an SNMP user and enabled SNMP notifications.

Before you begin

Make sure that you have configured an SNMP user and enabled SNMP notifications.

Procedure

	Command or Action	Purpose
Step 1	configure terminal Example: switch# configure terminal switch(config)#	Enters global configuration mode.
Step 2	rmon alarm <i>index mib-object sample-interval</i> { absolute delta } rising-threshold <i>value</i> [<i>event-index</i>] falling-threshold <i>value</i> [<i>event-index</i>] [owner name] Example: switch(config)# rmon alarm 20 1.3.6.1.2.1.2.2.1.14.1 2900 delta rising-threshold 1500 1 falling-threshold 0 owner test	Creates an RMON alarm. The value range is from -2147483647 to 2147483647. The owner name can be any alphanumeric string.
Step 3	rmon hcalarm <i>index mib-object sample-interval</i> { absolute delta } rising-threshold-high <i>value</i> rising-threshold-low <i>value</i> [<i>event-index</i>] falling-threshold-high <i>value</i> falling-threshold-low <i>value</i> [<i>event-index</i>] [owner name] [storagetype type] Example: switch(config)# rmon alarm 20 1.3.6.1.2.1.2.2.1.14.16777216 2900 delta rising-threshold-high 15 rising-threshold-low 151	Creates an RMON high-capacity alarm. The value range is from -2147483647 to 2147483647. The owner name can be any alphanumeric string. The storage type range is from 1 to 5.

	Command or Action	Purpose
	falling-threshold-high 0 falling-threshold-low 0 owner test	
Step 4	(Optional) show rmon {alarms hcalarms} Example: switch(config)# show rmon alarms	Displays information about RMON alarms or high-capacity alarms.
Step 5	(Optional) copy running-config startup-config Example: switch(config)# copy running-config startup-config	Copies the running configuration to the startup configuration.

11.7.2 Configuring RMON Events

You can configure RMON events to associate with RMON alarms. You can reuse the same event with multiple RMON alarms.

Before you begin

Make sure you have configured an SNMP user and enabled SNMP notifications.

Procedure

	Command or Action	Purpose
Step 1	configure terminal Example: switch# configure terminal switch(config)#	Enters global configuration mode.
Step 2	rmon event <i>index</i> [<i>description string</i>] [log] [<i>trap string</i>] [<i>owner name</i>] Example: switch(config)# rmon event 1 trap trap1	Configures an RMON event. The description string, trap string, and owner name can be any alphanumeric string.
Step 3	(Optional) show rmon events Example: switch(config)# show rmon events	Displays information about RMON events.
Step 4	(Optional) copy running-config startup-config Example: switch(config)# copy running-config startup-config	Copies the running configuration to the startup configuration.

11.8 Verifying the RMON Configuration

To display RMON configuration information, perform one of the following tasks:

Command	Purpose
show rmon alarms	Displays information about RMON alarms.
show rmon events	Displays information about RMON events.
show rmon hcalarms	Displays information about RMON high-capacity alarms.
show rmon logs	Displays information about RMON logs.

11.9 Configuration Examples for RMON

This example shows how to create a delta rising alarm on ifInOctets.14 and associates a notification event with this alarm:

```
configure terminal
rmon alarm 20 1.3.6.1.2.1.2.2.1.14.1 2900 delta rising-threshold 1500 1 falling-
threshold
0 owner test
rmon event 1 trap trap1
```

11.10 Feature History for RMON

The table below summarizes the new and changed features for this document and shows the releases in which each feature is supported. Your software release might not support all the features in this document. For the latest caveats and feature information, the release notes for your software release.

Table 24 Feature History for RMON

Feature Name	Releases	Feature Information
RMON	4.0(1)	This feature was introduced.

CHAPTER 12 Configuring Online Diagnostics

This chapter describes how to configure the generic online diagnostics (GOLD) feature on Inspur INOS devices.

This chapter contains the following sections:

- Finding Feature Information
- Information About Online Diagnostics
- Licensing Requirements for Online Diagnostics
- Guidelines and Limitations for Online Diagnostics
- Default Settings for Online Diagnostics
- Configuring Online Diagnostics
- Verifying the Online Diagnostics Configuration
- Configuration Examples for Online Diagnostics
- Additional References
- Feature History Table for Online Diagnostics

12.1 Finding Feature Information

Your software release might not support all the features documented in this module. For the latest caveats and feature information, the release notes for your software release. To find information about the features documented in this module, and to see a list of the releases in which each feature is supported, see the "New and Changed Information" chapter or the Feature History table in this chapter.

12.2 Information About Online Diagnostics

Online diagnostics help you verify that hardware and internal data paths are operating as designed so that you can rapidly isolate faults.

12.2.1 Online Diagnostics Overview

With online diagnostics, you can test and verify the hardware functionality of the device while the device is connected to a live network.

The online diagnostics contain tests that check different hardware components and verify the data path and control signals. Disruptive online diagnostic tests (such as the disruptive loopback test) and nondisruptive online diagnostic tests (such as the ASIC register check) run during bootup, line module online insertion and removal (OIR), and system reset. The nondisruptive online diagnostic tests run as part of the background health monitoring and you can run these tests on demand.

Online diagnostics are categorized as bootup, runtime or health-monitoring diagnostics, and on-demand diagnostics. Bootup diagnostics run during bootup, health-monitoring tests run in the background, and on-demand diagnostics run once or at user-designated intervals when the device is connected to a live network.

12.2.2 Bootup Diagnostics

Bootup diagnostics run during bootup and detect faulty hardware before Inspur INOS brings a module online. For example, if you insert a faulty module in the device, bootup diagnostics test the module and take it offline before the device uses the module to forward traffic.

Bootup diagnostics also check the connectivity between the supervisor and module hardware and the data and control paths for all the ASICs.

Bootup diagnostics log failures to onboard failure logging (OBFL) and syslog and trigger a diagnostic LED indication (on, off, pass, or fail).

You can configure the device to either bypass the bootup diagnostics or to run the complete set of bootup diagnostics.

12.2.3 Runtime or Health Monitoring Diagnostics

Runtime diagnostics are also called health monitoring (HM) diagnostics. These diagnostic tests provide information about the health of a live device. They detect runtime hardware errors, memory errors, the degradation of hardware modules over time, software faults, and resource exhaustion.

Runtime diagnostics are nondisruptive and run in the background to ensure the health of a device that is processing live network traffic. You can enable or disable runtime tests. You can change the runtime interval for a runtime test.

12.2.4 Recovery Actions for Specified Health-Monitoring Diagnostics

Before Inspur INOS Release 6.2(8), runtime tests did not take corrective recovery actions when they detected a hardware failure. The default action through EEM included generating alerts (callhome, syslog) and logging (OBFL, exception logs). These actions are informative, but they did not remove faulty devices from the network, which can lead to network disruption, traffic black holing, and so forth. Before Inspur INOS Release 6.2(8), you must manually shut the devices to recover the network.

In Inspur INOS Release 6.2(8) and later releases, you can configure the system to take disruptive action if the system detects failure on one of the following runtime, or health-monitoring, tests:

- PortLoopback test
- RewriteEngineLoopback test
- SnakeLoopback test
- StandbyFabricLoopback test

The recovery actions feature is disabled by default. With this feature you can configure the system to take disruptive action as a result of repeated failures on the health-monitoring, or runtime, tests. This feature enables or disables the corrective, conservative action on all four tests, simultaneously; the corrective action taken differs for each test. After crossing the maximum consecutive failure count for that test, the system takes corrective action.

With the recovery actions feature enabled, the corrective action for each test is as follows:

- PortLoopback test—The system moves the port registering faults to an error-disabled state.
- RewriteEngineLoopback test—The system takes different corrective action depending on whether the fault is with the supervisor, the fabric, or the port, as follows:
 - On a chassis with a standby supervisor, when the system detects a fault with the supervisor, the system switches over to the standby supervisor. If there is no standby supervisor in the chassis, the system does not take any action.
 - After failures on the fabric, the system will reload the fabric 3 times. If failure persists, the system powers down the fabric.
 - After the failures on a port, the system moves the faulty port to the error-disabled state.
- SnakeLoopback test—After the test detects 10 consecutive failures with any port on the module, the system will move the faulty port to an error-disabled state.
- StandbyFabricLoopback test—The system attempts to reload the standby supervisor three times after it receives errors on this test. If the system cannot reload the standby supervisor, the system powers off the supervisor.

Finally, the system maintains a history of the recovery actions that includes details of each action, the testing type, and the severity. You can display these counters.

12.2.5 On-Demand Diagnostics

On-demand tests help localize faults and are usually needed in one of the following situations:

- To respond to an event that has occurred, such as isolating a fault.
- In anticipation of an event that may occur, such as a resource exceeding its utilization limit.

You can run all the health monitoring tests on demand. You can schedule on-demand diagnostics to run immediately.

You can also modify the default interval for a health monitoring test.

12.2.6 High Availability

A key part of high availability is detecting hardware failures and taking corrective action while the device runs in a live network. Online diagnostics in high availability detect hardware failures and provide feedback to high availability software components to make switchover decisions.

Inspur INOS supports stateless restarts for online diagnostics. After a reboot or supervisor switchover, Inspur INOS applies the running configuration.

12.2.7 Virtualization Support

Inspur INOS supports online diagnostics in the default virtual device context (VDC) or, beginning with Inspur INOS Release 6.1, in the admin VDC. By default, Inspur INOS places you in the default VDC.

Online diagnostics are virtual routing and forwarding (VRF) aware. You can configure online diagnostics to use a particular VRF to reach the online diagnostics SMTP server.

12.3 Licensing Requirements for Online Diagnostics

Product	License Requirement
Inspur INOS	Online diagnostics require no license. Any feature not included in a license package is bundled with the Inspur INOS image and is provided at no extra charge to you. For a complete explanation of the Inspur INOS licensing scheme, see the <i>Inspur INOS Licensing Guide</i> .

12.4 Guidelines and Limitations for Online Diagnostics

Online diagnostics has the following configuration guidelines and limitations:

- You cannot run disruptive online diagnostic tests on demand.
- The F1 Series modules support the following tests: ASICRegisterCheck, PrimaryBootROM, SecondaryBootROM, EOBCPortLoopback, PortLoopback, and BootupPortLoopback.
 - Support for the RewriteEngineLoopback and SnakeLoopback tests on F1 Series modules is deprecated in Inspur INOS Release 5.2.
 - Beginning with Inspur INOS Release 6.1, F2 Series modules support the RewriteEngineLoopback and SnakeLoopback tests.
 - Beginning with Inspur INOS Release 7.3(0)DX(1), M3 Series modules support generic online diagnostics.

The following generic online diagnostics supported on M3 series:

Table 25 Generic Online Diagnostics Supported on M3 Series

ASICRegisterCheck	Health Monitoring/On Demand
PrimaryBootROM	Health Monitoring/On Demand
SecondaryBootROM	Health Monitoring/On Demand
EOBCPortLoopback	Bootup test only
OBFL	Bootup test only
PortLoopback	Health Monitoring/On Demand when port admin down only
RewriteEngineLoopback	Health Monitoring/On Demand
IntPortLoopback	Health Monitoring/On Demand
BootupPortLoopback	Bootup test only

12.5 Default Settings for Online Diagnostics

The following table lists the default settings for online diagnostic parameters.

Parameters	Default
Bootup diagnostics level	complete
Nondisruptive tests	active

12.6 Configuring Online Diagnostics

12.6.1 Setting the Bootup Diagnostic Level

You can configure the bootup diagnostics to run the complete set of tests or you can bypass all bootup diagnostic tests for a faster module bootup time.

Before you begin

Make sure that you are in the correct VDC. To change the VDC, use the `switchto vdc` command.

Procedure

	Command or Action	Purpose
Step 1	<code>switch# configure terminal</code>	Enters global configuration mode.
Step 2	<code>switch(config)# diagnostic bootup level {complete bypass}</code>	Configures the bootup diagnostic level to trigger diagnostics as follows when the device boots: <ul style="list-style-type: none"> complete—Perform all bootup diagnostics. The default is complete. bypass—Do not perform any bootup diagnostics.
Step 3	(Optional) <code>switch(config)# show diagnostic bootup level</code>	Displays the bootup diagnostic level (bypass or complete) that is currently in place on the device.
Step 4	(Optional) <code>switch(config)# copy running-config startup-config</code>	Copies the running configuration to the startup configuration.

12.6.2 Activating a Diagnostic Test

You can set a diagnostic test as active and optionally modify the interval (in hours, minutes, and seconds) at which the test runs.

Before you begin

Make sure that you are in the correct VDC. To change the VDC, use the `switchto vdc` command.

Procedure

	Command or Action	Purpose
Step 1	<code>switch# configure terminal</code>	Enters global configuration mode.
Step 2	(Optional) <code>switch(config)# diagnostic monitor interval module slot test [test-id name all] hour hour min minute second second</code>	Configures the interval at which the specified test is run. If no interval is set, the test runs at the interval set previously, or the default interval. The argument ranges are as follows: <ul style="list-style-type: none"> • <i>slot</i>—The range is from 1 to 10. • <i>test-id</i>—The range is from 1 to 14. • <i>name</i>—Can be any case-sensitive, alphanumeric string up to 32 characters. • <i>hour</i>—The range is from 0 to 23 hours. • <i>minute</i>—The range is from 0 to 59 minutes. • <i>second</i>—The range is from 0 to 59 seconds.
Step 3	<code>switch(config)# [no] diagnostic monitor module slot test [test-id name all]</code>	Activates the specified test. The argument ranges are as follows: <ul style="list-style-type: none"> • <i>slot</i>—The range is from 1 to 10. • <i>test-id</i>—The range is from 1 to 14. • <i>name</i>—Can be any case-sensitive, alphanumeric string up to 32 characters. The [no] form of this command inactivates the specified test. Inactive tests keep their current configuration but do not run at the scheduled interval.
Step 4	(Optional) <code>switch(config)# show diagnostic content module {slot all}</code>	Displays information about the diagnostics and their attributes.

12.6.3 Setting a Diagnostic Test as Inactive

You can set a diagnostic test as inactive. Inactive tests keep their current configuration but do not run at the scheduled interval.

Use the following command in global configuration mode to set a diagnostic test as inactive:

Command	Purpose
<code>no diagnostic monitor module slot test [test-id name all]</code>	Inactivates the specified test. The following ranges are valid for the each keyword: <ul style="list-style-type: none"> • slot —The range is from 1 to 10. • test-id —The range is from 1 to 14. • name —Can be any case-sensitive alphanumeric string up to 32 characters

12.6.4 Configuring Corrective Action

You can configure the device to take corrective action when it detects failures on any of the following runtime diagnostic tests:

- PortLoopback

- RewriteEngineLoopback
- SnakeLoopback
- StandbyFabricLoopback

Before you begin

Make sure that you are in the correct VDC. To change the VDC, use the `switchto vdc` command.

Procedure

	Command or Action	Purpose
Step 1	Required: <code>switch# configure terminal</code>	Enters global configuration mode.
Step 2	Required: <code>switch(config)# [no] diagnostic eem action conservative</code>	Enables or disables corrective actions when the system detects failures on port loopback, rewrite engine loopback, snake loopback, internal port loopback and standby fabric loopback tests. Note Use the no form of the command to disable these corrective actions.
Step 3	<code>switch# event gold [failure-type {sup fabric lc port}] module {module all} test {test-name test-id} [severity {major minor moderate}] testing-type {bootup monitoring ondemand scheduled} consecutive-failure count</code>	Triggers an event if the named online diagnostic test experiences the configured failure severity for the configured number of consecutive failures. The <i>module</i> specifies the number of the module that needs to be monitored. The <i>test-name</i> is the name of a configured online diagnostic test. The <i>test-id</i> specifies the test ID of the event criteria. The range is from 1 to 30. The <i>count</i> range is from 1 to 1000. Note This CLI command can be used to modify the consecutive failure count for GOLD system default policies.

12.6.5 Starting or Stopping an On-Demand Diagnostic Test

You can start or stop an on-demand diagnostic test. You can optionally modify the number of iterations to repeat this test, and the action to take if the test fails.

We recommend that you only manually start a disruptive diagnostic test during a scheduled network maintenance time.

Before you begin

Make sure that you are in the correct VDC. To change the VDC, use the `switchto vdc` command.

Procedure

	Command or Action	Purpose
Step 1	(Optional) <code>switch# diagnostic ondemand iteration number</code>	Configures the number of times that the on-demand test runs. The range is from 1 to 999. The default is 1.
Step 2	(Optional) <code>switch# diagnostic ondemand action-</code>	Configures the action to take if the on-demand test fails. The

	Command or Action	Purpose
	on-failure { continue failure-count <i>num-fails</i> stop }	<i>num-fails</i> range is from 1 to 999. The default is 1.
Step 3	Required: switch# diagnostic start module <i>slot</i> test [<i>test-id</i> <i>name</i> all non-disruptive] [port <i>port-number</i> all]	Starts one or more diagnostic tests on a module. The module slot range is from 1 to 10. The <i>test-id</i> range is from 1 to 14. The test name can be any case-sensitive, alphanumeric string up to 32 characters. The port range is from 1 to 48.
Step 4	Required: switch# diagnostic stop module <i>slot</i> test [<i>test-id</i> <i>name</i> all]	Stops one or more diagnostic tests on a module. The module slot range is from 1 to 10. The <i>test-id</i> range is from 1 to 14. The test name can be any case-sensitive, alphanumeric string up to 32 characters.
Step 5	(Optional) switch# show diagnostic status module <i>slot</i>	Verifies that the diagnostic has been scheduled.

12.6.6 Clearing Diagnostic Results

You can clear diagnostic test results.

Use the following command in any mode to clear the diagnostic test results:

Command	Purpose
diagnostic clear result module [<i>slot</i> all] test { <i>test-id</i> all }	Clears the test result for the specified test. The valid ranges are as follows: <ul style="list-style-type: none"> <i>slot</i>—The range is from 1 to 10. <i>test-id</i>—The range is from 1 to 14.

12.6.7 Simulating Diagnostic Results

You can simulate diagnostic test results.

Use the following command in any mode to simulate a diagnostic test result or clear the simulated test results:

Command	Purpose
diagnostic test simulation module <i>slot</i> test <i>test-id</i> { fail random-fail success } [port <i>number</i> all]	Simulates the test result for the specified test. The valid ranges are as follows: <ul style="list-style-type: none"> <i>slot</i>—The range is from 1 to 10. <i>test-id</i>—The range is from 1 to 14. port number—The range is from 1 to 48.
diagnostic test simulation module <i>slot</i> test <i>test-id</i> clear	Clears the simulated results for the specified test. The valid ranges are as follows: <ul style="list-style-type: none"> <i>slot</i>—The range is from 1 to 10. <i>test-id</i>—The range is from 1 to 14.

12.7 Verifying the Online Diagnostics Configuration

To display online diagnostics configuration information, perform one of the following tasks:

Command	Purpose
show diagnostic bootup level	Displays information about bootup diagnostics.
show diagnostic content module { <i>slot</i> all }	Displays information about diagnostic test content for a module.
show diagnostic description module <i>slot</i> test [<i>test-name</i>	Displays the diagnostic description.

Command	Purpose
all]	
show diagnostic eem [action [description] policy module {module number all}]	Displays the Embedded Event Manager (EEM) action level and the EEM policies configured for the level.
show diagnostic events [error info]	Displays diagnostic events by error and information event type.
show diagnostic ondemand setting	Displays information about on-demand diagnostics.
show diagnostic result module slot [test [test-name all]] [detail]	Displays information about the results of a diagnostic.
show diagnostic simulation module slot	Displays information about a simulated diagnostic.
show diagnostic status module slot	Displays the test status for all tests on a module.
show event manager events action-log event-type [gold gold_sup_failure gold_fabric_failure gold_module_failure gold_port_failure]	Displays the recovery action history for the specified failure, including the number of switchovers, reloads, and poweroffs, as well as timestamp, failure reason, module-id, port list, test name, testing type, and severity. This data is maintained across ungraceful reloads.
show hardware capacity [eobc forwarding interface module power]	Displays information about the hardware capabilities and current hardware utilization by the system.
show module	Displays module information including the online diagnostic test status.

12.8 Configuration Examples for Online Diagnostics

This example shows how to start all on-demand tests on module 6:

```
diagnostic start module 6 test all
```

This example shows how to activate test 2 and set the test interval on module 6:

```
configure terminal
diagnostic monitor module 6 test 2
diagnostic monitor interval module 6 test 2 hour 3 min 30 sec 0
```

12.9 Additional References

For additional information related to implementing online diagnostics, see the following sections:

12.9.1 Related Documents

Topics	Document Title
Online diagnostics CLI commands	<i>Inspur CN12700 Series INOS System Management Command Reference</i>
VDCs and VRFs	<i>Inspur CN12700 Series INOS Virtual Device Context Configuration Guide</i>

12.10 Feature History Table for Online Diagnostics

The following table lists the release history for this feature.

Feature Name	Releases	Feature Information
Online diagnostics (GOLD)	7.3(0)DX(1)	Added support for M3 Series modules for the following diagnostic tests: ASICRegisterCheck, PrimaryBootROM, SecondaryBootROM, EOBCPortLoopback, OBFL, PortLoopback, RewriteEngineLoopback, IntPortLoopback, and IntPortLoopback.
Online diagnostics (GOLD)	7.2(0)D1(1)	This feature was introduced.
Online diagnostics (GOLD)	6.2(10)	<ul style="list-style-type: none"> Added support for the CN127-F348XP-23 module for the PortLoopback test. Added support for all M2, F2, and F2e modules for the InternalPortLoopback test.
Recovery actions on specified health-monitoring diagnostics.	6.2(8)	Enables you to configure recovery actions for the following runtime diagnostic tests: PortLoopback, RewriteEngineLoopback, SnakeLoopback test , and StandbyFabricLoopback.
Online diagnostics (GOLD)	6.2(6)	Added support to all F3 modules except for CN127-F348XP-23.
Online diagnostics (GOLD)	6.1(1)	<ul style="list-style-type: none"> Added support for Supervisor 2 and M2 Series modules. Added support for F2 Series modules for the RewriteEngineLoopback and SnakeLoopback tests. Added support for configuring online diagnostics in the admin VDC.
Online diagnostics (GOLD)	5.2(1)	<ul style="list-style-type: none"> Enabled the SpineControlBus test on the standby supervisor. Deprecated the SnakeLoopback test on F1 Series modules.
Online diagnostics (GOLD)	5.1(2)	Added support for the SnakeLoopback test on F1 Series modules.
Online diagnostics (GOLD)	5.1(1)	Added support for the FIPS and BootupPortLoopback tests.
Online diagnostics (GOLD)	4.2(1)	Added support for the PortLoopback, StatusBus, and StandbyFabricLoopback tests.
Online diagnostics (GOLD)	4.0(1)	This feature was introduced.

CHAPTER 13 Configuring the Embedded Event Manager

This chapter describes how to configure the Embedded Event Manager (EEM) to detect and handle critical events on Inspur INOS devices.

This chapter includes the following sections:

- Finding Feature Information
- About EEM
- Licensing Requirements for EEM
- Prerequisites for EEM
- Guidelines and Limitations for EEM
- Default Settings for EEM
- Configuring EEM
- Verifying the EEM Configuration
- Configuration Examples for EEM
- Related Documents
- Feature History for EEM

13.1 Finding Feature Information

Your software release might not support all the features documented in this module. For the latest caveats and feature information, the release notes for your software release. To find information about the features documented in this module, and to see a list of the releases in which each feature is supported, see the "New and Changed Information" chapter or the Feature History table in this chapter.

13.2 About EEM

EEM monitors events that occur on your device and takes action to recover or troubleshoot these events, based on your configuration.

EEM consists of three major components:

- Event statements—Events to monitor from another Inspur INOS component that may require some action, workaround, or notification.
- Action statements—An action that EEM can take, such as sending an e-mail, or disabling an interface, to recover from an event.
- Policies—An event paired with one or more actions to troubleshoot or recover from the event.

13.2.1 Policies

An EEM policy consists of an event statement and one or more action statements. The event statement defines the event to look for as well as the filtering characteristics for the event. The action statement defines the action EEM takes when the event occurs.

This figure shows the two basic statements in an EEM policy.

Figure 2 EEM Policy Statements

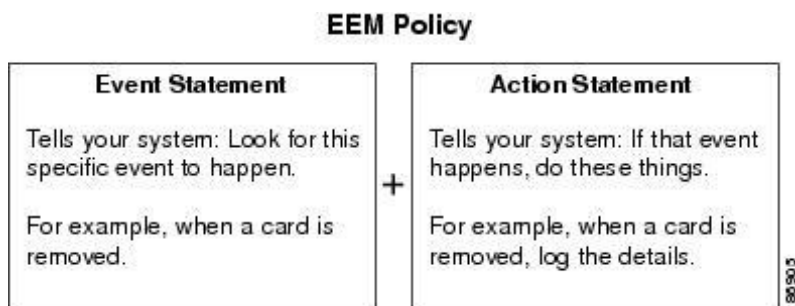

You can configure EEM policies using the command-line interface (CLI) or a VSH script.

EEM gives you a device-wide view of policy management. You configure EEM policies on the supervisor, and EEM pushes the policy to the correct module based on the event type. EEM takes any actions for a triggered event either locally on the module or on the supervisor (the default option).

EEM maintains event logs on the supervisor.

Inspur INOS has a number of preconfigured system policies. These system policies define many common events and actions for the device. System policy names begin with two underscore characters (`_ _`).

You can create user policies to suit your network. If you create a user policy, any actions in your policy occur after EEM triggers any system policy actions related to the same event as your policy.

You can also override some system policies. The overrides that you configure take the place of the system policy. You can override the event or the actions.

Use the `show event manager system-policy` command to view the preconfigured system policies and determine which policies that you can override.

The table below lists the system policies that can be completely overridden and policies that are only augmented.

System Policy	Can be completely overridden? Note Policies with default actions that cannot be completely overridden will be augmented.
<code>_ _BootupPortLoopback</code>	No
<code>_ _FIPS</code>	No
<code>_ _IntPortLoopback</code>	No
<code>_ _PortLoopback</code>	No
<code>_ _RewriteEngineLoopback</code>	No
<code>_ _SnakeLoopback</code>	No
<code>_ _SwPortLoopback</code>	No
<code>_ _asic_register_check</code>	Yes
<code>_ _compact flash</code>	Yes
<code>_ _eobc_port loopback</code>	Yes
<code>_ _ethpm debug 1</code>	No
<code>_ _ethpm debug 2</code>	No
<code>_ _ethpm debug 3</code>	No
<code>_ _ethpm debug 4</code>	No
<code>_ _ethpm link flap</code>	No
<code>_ _external compact flash</code>	Yes
<code>_ _gold obfl</code>	Yes
<code>_ _lcm module failure</code>	Yes

13.2.2 Event Statements

An event is any device activity for which some action, such as a workaround or a notification, should be taken. In many cases, these events are related to faults in the device such as when an interface or a fan malfunctions.

EEM defines event filters so only critical events or multiple occurrences of an event within a specified time period trigger an associated action.

This figure shows events that are handled by EEM.

Figure 3 EEM Overview

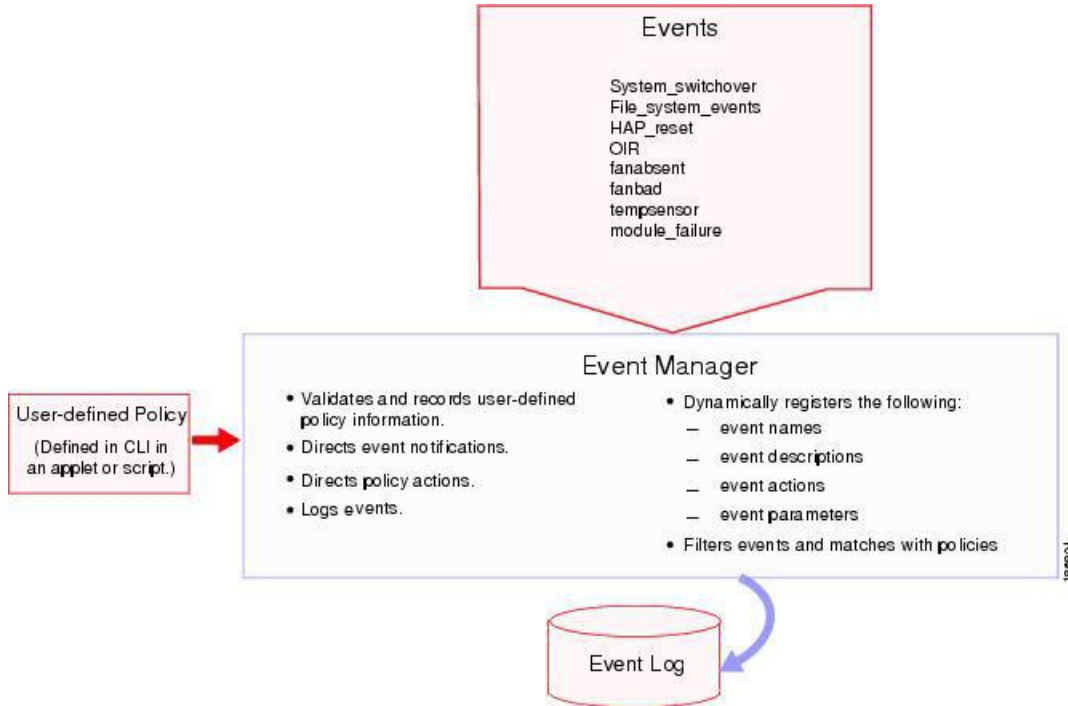

Event statements specify the event that triggers a policy to run. You can configure multiple event triggers.

EEM schedules and runs policies on the basis of event statements. EEM examines the event and action commands and runs them as defined.

13.2.3 Action Statements

Action statements describe the action triggered by a policy. Each policy can have multiple action statements. If no action is associated with a policy, EEM still observes events but takes no actions.

EEM supports the following actions in action statements:

- Execute any CLI commands.
- Update a counter.
- Log an exception.
- Force the shutdown of any module.
- Reload the device.
- Shut down specified modules because the power is over budget.
- Generate a syslog message.
- Generate a Call Home event.
- Generate an SNMP notification.
- Use the default action for the system policy.

13.2.4 VSH Script Policies

You can also write policies in a VSH script, using a text editor. These policies have an event statement and action statement(s) just as other policies, and these policies can either augment or override system policies. After you write your VSH script policy, copy it to the device and activate it.

13.2.5 Environment Variables

You can define environment variables for EEM that are available for all policies. Environment variables are useful for configuring common values that you can use in multiple policies. For example, you can create an environment variable for the IP address of an external e-mail server.

You can use an environment variable in action statements by using the parameter substitution format.

This example shows a sample action statement to force a module 1 shutdown, with a reset reason of "EEM action."

```
switch (config-eem-policy)# action 1.0 forceshut module 1 reset-reason "EEM
action."
```

If you define an environment variable for the shutdown reason, called default-reason, you can replace that reset reason with the environment variable, as shown in the following example.

```
switch (config-eem-policy)# action 1.0 foreshut module 1 reset-reason $default-
reason
```

You can reuse this environment variable in any policy.

13.2.6 EEM Event Correlation

You can trigger an EEM policy based on a combination of events. First, you use the tag keyword to create and differentiate multiple events in the EEM policy. Then using a set of boolean operators (and, or, andnot), along with the count and time, you can define a combination of these events to trigger a custom action.

13.2.7 High Availability

Inspur INOS supports stateless restarts for EEM. After a reboot or supervisor switchover, Inspur INOS applies the running configuration.

13.2.8 Virtualization Support

You configure EEM in the virtual device context (VDC) that you are logged into. By default, Inspur INOS places you in the default VDC. You must be in this VDC to configure policies for module-based events.

Not all actions or events are visible in all VDCs. You must have network-admin or vdc-admin privileges to configure policies.

13.3 Prerequisites for EEM

EEM has the following prerequisites:

- The username: admin (with network-admin or vdc-admin user privileges) is required to configure EEM on a nondefault VDC.

13.4 Guidelines and Limitations for EEM

EEM has the following configuration guidelines and limitations:

- The maximum number of configurable EEM policies is 500.
- Action statements within your user policy or overriding policy should not negate each other or adversely affect the associated system policy.
 - If you want to allow a triggered event to process any default actions, you must configure the EEM policy to allow the default action. For example, if you match a CLI command in a match statement, you must add the event-default action statement to the EEM policy or EEM will not allow the CLI command to execute.
 - An override policy that consists of an event statement and no action statement triggers no action and no notification of failures.
 - An override policy without an event statement overrides all possible events in the system policy.
- The following rules apply to regular command expressions: all keywords must be expanded, and only the * symbol can be used for argument replacement.
- EEM event correlation is supported only on the supervisor module.
- EEM event correlation is not supported across different modules within a single policy.
- EEM event correlation supports up to four event statements in a single policy. The event types can be the same or different, but only these event types are supported: cli, counter, module, module-failure, oir, snmp, and syslog.
 - When more than one event statement is included in an EEM policy, each event statement must have a tag keyword with a unique tag argument.
 - EEM event correlation does not override the system default policies.
 - Default action execution is not supported for policies that are configured with tagged events.
- While using an EEM applet, the copy r bootflash:last_config command prompts for overriding the configuration file if the same file name is present. You need to add the terminal dont-ask if you are prompted to proceed with overwriting a file in an EEM applet. Refer to the example given below.

```
event manager applet test
  event cli match "rollback *"
  action 1.0 cli command "terminal dont-ask"
  action 2.0 cli command "copy running-config bootflash:last_config"
  action 3.0 cli command "no terminal dont-ask"
```

- You can invoke EEM from Python. For more information about Python, see the Inspur CN12700 Series INOS Programmability Guide.

13.5 Default Settings for EEM

This table lists the default settings for EEM parameters.

Parameters	Default
System policies	Active

13.6 Configuring EEM

You can create policies that contain actions to take based on system policies. To display information about the system policies, use the show event manager system-policy command.

13.6.1 Defining an Environment Variable

You can define a variable to serve as a parameter in an EEM policy.

Procedure

	Command or Action	Purpose
Step 1	configure terminal Example: switch# configure terminal switch(config)#	Enters global configuration mode.
Step 2	event manager environment <i>variable-name</i> <i>variable-value</i> Example: switch(config)# event manager environment emailto "admin@anyplace.com"	Creates an environment variable for EEM. The <i>variable-name</i> can be any case-sensitive, alphanumeric string up to 29 characters. The <i>variable-value</i> can be any quoted alphanumeric string up to 39 characters.
Step 3	(Optional) show event manager environment { <i>variable-name</i> all} Example: switch(config)# show event manager environment all	Displays information about the configured environment variables.
Step 4	(Optional) copy running-config startup-config Example: switch(config)# copy running-config startup- config	Copies the running configuration to the startup configuration.

13.6.2 Defining a User Policy Using the CLI

You can define a user policy using the CLI to the device.

Procedure

	Command or Action	Purpose
Step 1	configure terminal Example: switch# configure terminal switch(config)#	Enters global configuration mode.
Step 2	event manager applet <i>applet-name</i> Example: switch(config)# event manager applet monitorShutdown switch(config-applet)#	Registers the applet with EEM and enters applet configuration mode. The <i>applet-name</i> can be any case-sensitive, alphanumeric string up to 29 characters.
Step 3	(Optional) description <i>policy-description</i> Example: switch(config-applet)# description "Monitors interface shutdown."	Configures a descriptive string for the policy. The string can be any alphanumeric string up to 80 characters. Enclose the string in quotation marks.
Step 4	event <i>event-statement</i> Example: switch(config-applet)# event cli match "conf t ; interface * ; shutdown"	Configures the event statement for the policy. Repeat this step for multiple event statements.
Step 5	(Optional) tag <i>tag</i> { and andnot or } <i>tag</i> [and andnot or { <i>tag</i> }] { happens <i>occurs</i> in <i>seconds</i> } Example: switch(config-applet)# tag one or two happens 1 in 10000	Correlates multiple events in the policy. The range for the <i>occurs</i> argument is from 1 to 4294967295. The range for the <i>seconds</i> argument is from 0 to 4294967295 seconds.

	Command or Action	Purpose
Step 6	action <i>label action-statement</i> Example: switch(config-applet)# action 1.0 cli show interface e 3/1	Configures an action statement for the policy. Repeat this step for multiple action statements..
Step 7	(Optional) show event manager policy-state <i>name [module module-id]</i> Example: switch(config-applet)# show event manager policy-state monitorShutdown	Displays information about the status of the configured policy.
Step 8	(Optional) copy running-config startup-config Example: switch(config)# copy running-config startup-config	Copies the running configuration to the startup configuration.

13.6.2.1 Configuring Event Statements

Use one of the following commands in Applet Configuration mode to configure an event statement:

Command	Purpose
event application [tag <i>tag</i>] sub-system <i>sub-system-id</i> type <i>event-type</i> Example: switch(config-applet)# event application sub-system 798 type 1	Triggers an event when an event specification matches the subsystem ID and application event type. The range for the <i>sub-system-id</i> and for the <i>event-type</i> is from 1 to 4294967295. The tag <i>tag</i> keyword-argument pair identifies this specific event when multiple events are included in the policy. Note To use this command, you must first enable the feature evmed command to enable generic event detectors.
event cli [tag <i>tag</i>] match <i>expression</i> [count <i>repeats</i> time <i>seconds</i>] Example: switch(config-applet)# event cli match "conf t ; interface * ; shutdown"	Triggers an event if you enter a command that matches the regular expression. The tag <i>tag</i> keyword-argument pair identifies this specific event when multiple events are included in the policy. The <i>repeats</i> range is from 1 to 65000. The time range, in seconds, is from 0 to 4294967295, where 0 indicates no time limit.
event counter [tag <i>tag</i>] name <i>counter</i> entry-val <i>entry</i> entry-op { eq ge gt le lt ne } [exit-val <i>exit</i> exit-op { eq ge gt le lt ne }] Example: switch(config-applet)# event counter name mycounter entry-val 20 gt	Triggers an event if the counter crosses the entry threshold based on the entry operation. The event resets immediately. Optionally, you can configure the event to reset after the counter passes the exit threshold. The tag <i>tag</i> keyword-argument pair identifies this specific event when multiple events are included in the policy. The <i>counter</i> name can be any

Command	Purpose
	case-sensitive, alphanumeric string up to 28 characters. The <i>entry</i> and <i>exit</i> value ranges are from 0 to 2147483647.
event fanabsent [<i>fan number</i>] time <i>seconds</i> Example: switch(config-applet)# event fanabsent time 300	Triggers an event if a fan is removed from the device for more than the configured time, in seconds. The <i>number</i> range is module dependent. The <i>seconds</i> range is from 10 to 64000.
event fanbad [<i>fan number</i>] time <i>seconds</i> Example: switch(config-applet)# event fanbad time 3000	Triggers an event if a fan fails for more than the configured time, in seconds. The <i>number</i> range is module dependent. The <i>seconds</i> range is from 10 to 64000.
event fib { <i>adjacency extra</i> <i>resource tcam usage</i> <i>route {extra inconsistent missing}</i> } Example: switch(config-applet)# event fib adjacency extra	Triggers an event for one of the following: <ul style="list-style-type: none"> adjacency extra—If there is an extra route in the unicast FIB. resource tcam usage—Each time the TCAM utilization percentage becomes a multiple of 5, in either direction. route {extra inconsistent missing}—If a route is added, changed, or deleted in the unicast FIB.
event gold [<i>failure-type {sup fabric lc port}</i>] module { <i>module</i> all } test { <i>test-name</i> <i>test-id</i> } [<i>severity {major minor moderate}</i>] testing-type { <i>bootup</i> <i>monitoring</i> <i>ondemand</i> <i>scheduled</i> } consecutive-failure <i>count</i> Example: switch(config-applet)# event gold failure-type module 2 test 7 ASICRegisterCheck testing-type ondemand consecutive-failure 2	Triggers an event if the named online diagnostic test experiences the configured failure severity for the configured number of consecutive failures. The <i>module</i> specifies the number of the module that needs to be monitored. The <i>test-name</i> is the name of a configured online diagnostic test. The <i>test-id</i> specifies the test ID of the event criteria. The range is from 1 to 30. The <i>count</i> range is from 1 to 1000.
event interface [<i>tag tag</i>] { <i>name interface slot/port</i> parameter } Example: switch(config-applet)# event interface ethernet 2/2 parameter	Triggers an event if the counter is exceeded for the specified interface. The <i>tag tag</i> keyword-argument pair identifies this specific event when multiple events are included in the policy. Note To use this command, you must first enable the feature evmed command to enable generic event detectors.
event memory { <i>critical</i> <i>minor</i> <i>severe</i> } Example: switch(config-applet)# event memory critical	Triggers an event if a memory threshold is crossed.
event module [<i>tag tag</i>] status { <i>online</i> <i>offline</i> <i>any</i> } module { <i>all</i> <i>module-num</i> } Example: switch(config-applet)# event module status offline module all	Triggers an event if the specified module enters the selected status. The <i>tag tag</i> keyword-argument pair identifies this specific event when multiple events are included in the policy.
event module-failure [<i>tag tag</i>] type <i>failure-type</i> module { <i>slot</i> all } count <i>repeats</i> [<i>time seconds</i>]	Triggers an event if a module experiences the failure type configured.

Command	Purpose
<p>Example: switch(config-applet)# event module-failure type lc-failed module 3 count 1</p>	<p>The tag tag keyword-argument pair identifies this specific event when multiple events are included in the policy. The <i>repeats</i> range is from 0 to 4294967295. The <i>seconds</i> range is from 0 to 4294967295, where 0 indicates no time limit.</p>
<p>event none Example: switch(config-applet)# event none</p>	<p>Manually runs the policy event without any events specified. Note To use this command, you must first enable the feature evmed command to enable generic event detectors.</p>
<p>event oir [tag tag] {fan module powersupply} {anyoir insert remove} [number] Example: switch(config-applet)# event oir fan remove 4</p>	<p>Triggers an event if the configured device element (fan, module, or power supply) is inserted or removed from the device. The tag tag keyword-argument pair identifies this specific event when multiple events are included in the policy. You can optionally configure a specific fan, module, or power supply number. The <i>number</i> range is as follows:</p> <ul style="list-style-type: none"> • Fan number—Module dependent. • Module number—Device dependent. • Power supply number—The range is from 1 to 3.
<p>event policy-default count repeats [time seconds] Example: switch(config-applet)# event policy-default count 3</p>	<p>Uses the event configured in the system policy. Use this option for overriding policies. The <i>repeats</i> range is from 1 to 65000. The <i>seconds</i> range is from 0 to 4294967295, where 0 indicates no time limit.</p>
<p>event poweroverbudget Example: switch(config-applet)# event poweroverbudget</p>	<p>Triggers an event if the power budget exceeds the capacity of the configured power supplies.</p>
<p>event snmp [tag tag] oid oid get-type {exact next} entry-op {eq ge gt le lt ne} entry-val entry [exit-comb {and or}] exit-op {eq ge gt le lt ne} exit-val exit exit-time time polling-interval interval Example: switch(config-applet)# event snmp oid 1.3.6.1.2.1.31.1.1.1.6 get-type next entry-op lt 300 entry-val 0 exit-op eq 400 exit-time 30 polling-interval 300</p>	<p>Triggers an event if the SNMP OID crosses the entry threshold based on the entry operation. The event resets immediately, or optionally you can configure the event to reset after the counter passes the exit threshold. The OID is in dotted decimal notation. The tag tag keyword-argument pair identifies this specific event when multiple events are included in the policy. The <i>entry</i> and <i>exit</i> value ranges are from 0 to 18446744073709551615. The time, in seconds, is from 0 to 2147483647. The interval, in seconds, is from 1 to 2147483647.</p>

Command	Purpose
event storm-control Example: switch(config-applet)# event storm-control	Triggers an event if traffic on a port exceeds the configured storm control threshold.
event syslog [<i>occurs count</i>] { <i>pattern string</i> period time priority level tag tag } Example: switch(config-applet)# event syslog period 500	Triggers an event if the specified syslog threshold is exceeded. The range for the count is from 1 to 65000, and the range for the time is from 1 to 4294967295. The priority range is from 0 to 7. The tag tag keyword-argument pair identifies this specific event when multiple events are included in the policy.
event sysmgr memory [<i>module module-num</i>] major major-percent minor minor-percent clear clear-percent Example: switch(config-applet)# event sysmgr memory minor 80	Triggers an event if the specified system manager memory threshold is exceeded. The range for the percentage is from 1 to 99.
event sysmgr switchover count <i>count time interval</i> Example: switch(config-applet)# event sysmgr switchover count 10 time 1000	Triggers an event if the specified switchover count is exceeded within the time interval specified. The switchover count is from 1 to 65000. The time interval is from 0 to 2147483647.
event temperature [<i>module slot</i>] [<i>sensor-number</i>] threshold { any major minor } Example: switch(config-applet)# event temperature module 2 threshold any	Triggers an event if the temperature sensor exceeds the configured threshold. The sensor range is from 1 to 18.
event timer { absolute time <i>time name name</i> countdown time <i>time name name</i> cron cronentry string tag tag watchdog time <i>time name name</i> } Example: switch(config-applet)# event timer absolute time 100 name abtimer	Triggers an event if the specified time is reached. The range for the time is from 1 to 4294967295. <ul style="list-style-type: none"> • absolute time—Triggers an event when the specified absolute time of day occurs. • countdown time—Triggers an event when when the specified time counts down to zero. The timer does not reset. • cron cronentry—Triggers an event when the CRON string specification matches the current time. • watchdog time—Triggers an event when the specified time counts down to zero. The timer automatically resets to the initial value and continues to count down. <p>The tag tag keyword-argument pair identifies this specific event when multiple events are included in the policy.</p> <p>Note To use this command, you must first enable the feature evmed command to enable generic event detectors.</p>
event track [<i>tag tag</i>] <i>object-number state</i> { any down up } Example: switch(config-applet)# event track 1 state down	Triggers an event if the tracked object is in the configured state. The tag tag keyword-argument pair identifies this specific event when multiple events are included in the policy.

Command	Purpose
	The <i>object-number</i> range is from 1 to 500.

13.6.2.2 Configuring Action Statements

Use any of the following commands in Applet configuration (config-applet) mode to configure action statements:

Command	Purpose
action label cli command1 [command2...] [local] Example: switch(config-applet)# action 1.0 cli "show interface e 3/1"	Runs the configured CLI commands. You can optionally run the commands on the module where the event occurred. The action label is in the format number1.number2. <i>number1</i> can be any number up to 16 digits. The range for <i>number2</i> is from 0 to 9.
action label counter name counter value val op {dec inc nop set} Example: switch(config-applet)# action 2.0 counter name mycounter value 20 op inc	Modifies the counter by the configured value and operation. The action label is in the format number1.number2. <i>number1</i> can be any number up to 16 digits. The range for <i>number2</i> is from 0 to 9. The counter name can be any case-sensitive, alphanumeric string up to 28 characters. The <i>val</i> can be an integer from 0 to 2147483647 or a substituted parameter.
action label event-default Example: switch(config-applet)# action 1.0 event-default	Executes the default action for the associated event. The action label is in the format number1.number2. <i>number1</i> can be any number up to 16 digits. The range for <i>number2</i> is from 0 to 9.
action label forceshut [module slot xbar xbar-number] reset-reason seconds Example: switch(config-applet)# action 1.0 forceshut module 2 reset-reason "flapping links"	Forces a module, crossbar, or the entire system to shut down. The action label is in the format number1.number2. <i>number1</i> can be any number up to 16 digits. The range for <i>number2</i> is from 0 to 9. The reset reason is a quoted alphanumeric string up to 80 characters.
action label overbudgetshut [module slot[-slot]] Example: switch(config-applet)# action 1.0 overbudgetshut module 3-5	Forces one or more modules or the entire system to shut down because of a power overbudget issue. The action label is in the format number1.number2. <i>number1</i> can be any number up to 16 digits. The range for <i>number2</i> is from 0 to 9.
action label policy-default Example: switch(config-applet)# action 1.0 policy-default	Executes the default action for the policy that you are overriding. The action label is in the format number1.number2. <i>number1</i> can be any number up to 16 digits. The range for <i>number2</i> is from 0 to 9.
action label publish-event Example: switch(config-applet)# action 1.0 publish-event	Forces the publication of an application-specific event. The action label is in the format number1.number2. <i>number1</i> can be any number up to 16 digits. The range for <i>number2</i> is from 0 to 9.
action label reload [module slot[-slot]] Example: switch(config-applet)# action 1.0 reload module 3-5	Forces one or more modules or the entire system to reload. The action label is in the format number1.number2.

Command	Purpose
	<i>number1</i> can be any number up to 16 digits. The range for <i>number2</i> is from 0 to 9.
action label snmp-trap {[intdata1 data [intdata2 data]] [strdata string]} Example: switch(config-applet)# action 1.0 snmp-trap strdata "temperature problem"	Sends an SNMP trap with the configured data. The action label is in the format number1.number2 <i>number1</i> can be any number up to 16 digits. The range for <i>number2</i> is from 0 to 9. The <i>data</i> arguments can be any number up to 80 digits. The <i>string</i> can be any alphanumeric string up to 80 characters.
action label syslog [priority prio-val] msg error-message Example: switch(config-applet)# action 1.0 syslog priority notifications msg "cpu high"	Sends a customized syslog message at the configured priority. The action label is in the format number1.number2. <i>number1</i> can be any number up to 16 digits. The range for <i>number2</i> is from 0 to 9. The <i>error-message</i> can be any quoted alphanumeric string up to 80 characters.
action label end Example: switch(config-applet)# action 1.0 end	Identifies the end of a conditional action block like if/else and while. The action label is in the format number1.number2. <i>number1</i> can be any number up to 16 digits. The range for <i>number2</i> is from 0 to 9.
action label exit [result] Example: switch(config-applet)# action 1.0 exit 25	Exits from the applet configuration mode that is currently running. The action label is in the format number1.number2. <i>number</i> can be any number up to 16 digits. The range for <i>number2</i> is from 0 to 9.
action label else Example: switch(config-applet)# action 1.0 else	Identifies the beginning of an <i>else</i> conditional action block in an <i>if/else</i> action block. The action label is in the format number1.number2. <i>number1</i> can be any number up to 16 digits. The range for <i>number2</i> is from 0 to 9.
action label elseif string-1 {eq gt ge lt le ne} string-2 switch(config-applet)# action 1.0 elseif \$x ge 10	Identifies the beginning of an <i>elseif</i> conditional action block in an <i>else/if</i> action block. The action label is in the format number1.number2. <i>number1</i> can be any number up to 16 digits. The range for <i>number2</i> is from 0 to 9.
action label if string-1 {eq gt ge lt le ne} string-2 switch(config-applet)# action 1.0 if \$x lt 10	Identifies the beginning of an <i>if</i> conditional action block. The action label is in the format number1.number2. <i>number1</i> can be any number up to 16 digits. The range for <i>number2</i> is from 0 to 9.
action label if string-1 {eq gt ge lt le ne} string-2 goto label switch(config-applet)# action 2.0 if \$x lt 10 goto 1.0	Instructs the applet to jump to a given label if the specified condition is true. The action label is in the format number1.number2. <i>number1</i> can be any number up to 16 digits. The range for <i>number2</i> is from 0 to 9.
action label puts string Example: switch(config-applet)# action 2.0 puts "Hello world"	Enables the action of printing data directly to the terminal. The action label is in the format number1.number2. <i>number1</i> can be any number up to 16 digits. The range for <i>number2</i> is from 0 to 9.

Command	Purpose
action label add <i>{long-integer variable-name}</i> <i>{long-integer variable-name}</i> Example: switch(config-applet)# action 2.0 add \$var1 10	Specifies the action of adding two variables. The action label is in the format number1.number2. <i>number1</i> can be any number up to 16 digits. The range for <i>number2</i> is from 0 to 9.
action label decrement <i>variable-name long-integer</i> Example: switch(config-applet)# action 1.0 decrement \$varname 12	Specifies the action of decrementing the value of a variable. The action label is in the format number1.number2. <i>number1</i> can be any number up to 16 digits. The range for <i>number2</i> is from 0 to 9.
action label increment <i>variable-name long-integer</i> Example: switch(config-applet)# action 2.0 increment \$varname 12	Specifies the action of incrementing the value of a variable. The action label is in the format number1.number2. <i>number1</i> can be any number up to 16 digits. The range for <i>number2</i> is from 0 to 9.
action label multiply <i>{long-integer1 variable-name1}</i> <i>{long-integer2 variable-name2}</i> switch(config-applet)# action 2.0 multiply 12 35	Specifies the action of multiplying a variable value with a long integer value. The action label is in the format number1.number2. <i>number1</i> can be any number up to 16 digits. The range for <i>number2</i> is from 0 to 9.
action label subtract <i>{long-integer1 variable-name1}</i> <i>{long-integer2 variable-name2}</i> Example: switch(config-applet)# action 2.0 subtract \$var1 \$var2	Specifies the action of subtracting the value of a variable from another one. The action label is in the format number1.number2. <i>number1</i> can be any number up to 16 digits. The range for <i>number2</i> is from 0 to 9.
action label comment <i>string</i> Example: switch(config-applet)# action 2.0 comment keyvalue	Adds comments to applets. The action label is in the format number1.number2. <i>number1</i> can be any number up to 16 digits. The range for <i>number2</i> is from 0 to 9.
action label break Example: switch(config-applet)# action 2.0 break	Specifies the action of exiting from a loop of actions. The action label is in the format number1.number2. <i>number1</i> can be any number up to 16 digits. The range for <i>number2</i> is from 0 to 9.
action label continue Example: switch(config-applet)# action 2.0 continue	Specifies the action of continuing with a loop of actions. The action label is in the format number1.number2. <i>number1</i> can be any number up to 16 digits. The range for <i>number2</i> is from 0 to 9.
action label foreach <i>string-iterator string-input</i> <i>[string-delimiter]</i> Example: switch(config-applet)# action 3.1 foreach _iterator "orange blue green"	Specifies the iteration of an input string using the delimiter as the tokenizing pattern. The action label is in the format number1.number2. <i>number1</i> can be any number up to 16 digits. The range for <i>number2</i> is from 0 to 9.
action label while <i>string-op-1 operator string-op-2</i> Example: switch(config-applet)# action 3.2 while \$i lt 10	Identifies the beginning of a loop action block. The action label is in the format number1.number2. <i>number1</i> can be any number up to 16 digits. The range for <i>number2</i> is from 0 to 9. Valid values for <i>operator</i> are: ge, gt, eq, ne, lt, le.

Use any of the following action commands in Applet Configuration (config-applet) mode to enable string operations.

Command	Purpose
action label append <i>var-name</i> [<i>var-value</i>] switch(config-applet)# action 4.2 append \$var 12	Specifies the action of appending the string value to the current value of a variable. The action label is in the format <i>number1.number2</i> . <i>number1</i> can be any number up to 16 digits. The range for <i>number2</i> is from 0 to 9. If the variable does not exist, it will be created and set to the given value.
action label regexp <i>string-pattern string-input</i> [<i>string-match</i> [<i>string-submatch1</i>] [<i>string-submatch2</i>] [<i>string-submatch3</i>]] switch(config-applet)# action 4.3 regexp "(.*) (.*) (.*)" "one two three" _match _sub1	Matches the regular expression in <i>string-pattern</i> on the <i>string-input</i> . <i>string-match</i> and <i>string-submatch</i> store the results of the match. The action label is in the format <i>number1.number2</i> . <i>number1</i> can be any number up to 16 digits. The range for <i>number2</i> is from 0 to 9.
action label string compare [<i>nocase</i>] [<i>length integer</i>] <i>string1 string2</i> switch(config-applet)# action 4.5 string compare nocase length 3	Compares two unequal strings. The result is stored in the inbuilt variable <i>\$_string_result</i> . The action label is in the format <i>number1.number2</i> . <i>number</i> can be any number up to 16 digits. The range for <i>number2</i> is from 0 to 9.
action label string equal [<i>nocase</i>] [<i>length integer</i>] <i>string1 string2</i> switch(config-applet)# action 4.5 string equal "contains" "data"	Compares two strings and returns 1 if the two strings are equal. The result is stored in the inbuilt variable <i>\$_string_result</i> . The action label is in the format <i>number1.number2</i> . <i>number1</i> can be any number up to 16 digits. The range for <i>number2</i> is from 0 to 9.
action label string first <i>string1 string2</i> [<i>index-value</i>] switch(config-applet)# action 4.6 string first "contains" \$str	Returns the index of the first occurrence of <i>string1</i> within <i>string2</i> . <i>index-value</i> is optional and indicates the position to start the first test. The action label is in the format <i>number1.number2</i> . <i>number1</i> can be any number up to 16 digits. The range for <i>number2</i> is from 0 to 9.
action label string index <i>string</i> [<i>value end</i>] switch(config-applet)# action 4.7 string index "this is a test" 6	Returns the characters specified at the given <i>index-value</i> . <i>end</i> denotes the last character of the string. The characters are stored in the inbuilt variable <i>\$_string_result</i> . The action label is in the format <i>number1.number2</i> . <i>number1</i> can be any number up to 16 digits. The range for <i>number2</i> is from 0 to 9.
action label string last <i>string1 string2</i> [<i>index-value</i>] switch(config-applet)# action 4.9 string last "contains" \$str	Returns the index of the last occurrence of <i>string1</i> within <i>string2</i> . The action label is in the format <i>number1.number2</i> . <i>number1</i> can be any number up to 16 digits. The range for <i>number2</i> is from 0 to 9.
action label string length <i>string</i> switch(config-applet)# action 5.0 string length "contains"	Returns the number of characters in a string. The result is stored in the inbuilt variable <i>\$_string_result</i> . The action label is in the format <i>number1.number2</i> . <i>number1</i> can be any number up to 16 digits. The range for <i>number2</i> is from 0 to 9.
action label string match [<i>nocase</i>] <i>string-pattern string</i> switch(config-applet)# action 5.2 string match	Matches <i>string</i> with a specified pattern, <i>string-pattern</i> . If they match, the result 1 is stored in the inbuilt variable <i>\$_string_result</i> .

Command	Purpose
"*B1*" \$str	The action label is in the format <i>number1.number2</i> . <i>number1</i> can be any number up to 16 digits. The range for <i>number2</i> is from 0 to 9.
action label string range <i>string start-index end-index</i> switch(config-applet)# action 5.2 string range "\$data" 4 9	Stores a range of characters in a string, starting from the <i>start-index</i> and ending at <i>end-index</i> . The resultant characters are stored in the inbuilt variable <i>\$_string_result</i> . The action label is in the format <i>number1.number2</i> . <i>number1</i> can be any number up to 16 digits. The range for <i>number2</i> is from 0 to 9.
action label string replace <i>string start-index end-index [new-string]</i> switch(config-applet)# action 5.4 string replace \$str 1 4 "test"	Forms a new string by replacing specific characters of a string. If <i>new-string</i> is not specified, it replaces the characters with whitespace. The newly formed string is stored in the inbuilt variable <i>\$_string_result</i> . The action label is in the format <i>number1.number2</i> . <i>number</i> can be any number up to 16 digits. The range for <i>number2</i> is from 0 to 9.
action label string tolower <i>string [start-index] [end-index]</i> switch(config-applet)# action 5.5 string tolower "\$string" 11 16	Stores a specific range of characters of a string in lowercase. The characters are stored in the inbuilt variable <i>\$_string_result</i> . The action label is in the format <i>number1.number2</i> . <i>number1</i> can be any number up to 16 digits. The range for <i>number2</i> is from 0 to 9.
action label string toupper <i>string [start-index] [end-index]</i> switch(config-applet)# action 5.6 string toupper "\$string" 0 7	Stores a specific range of characters of a string in uppercase. The characters are stored in the inbuilt variable <i>\$_string_result</i> . The action label is in the format <i>number1.number2</i> . <i>number</i> can be any number up to 16 digits. The range for <i>number2</i> is from 0 to 9.
action label string trim <i>string1 [string2]</i> switch(config-applet)# action 5.7 string trim "\$string"	Trims the characters in <i>string2</i> from both ends of <i>string1</i> . By default, <i>string2</i> corresponds to whitespace. The action label is in the format <i>number1.number2</i> . <i>number1</i> can be any number up to 16 digits. The range for <i>number2</i> is from 0 to 9.
action label string trimleft <i>string1 [string2]</i> switch(config-applet)# action 5.7 string trimleft "\$string" "Hello"	Trims the characters in <i>string2</i> from the left end of <i>string1</i> . By default, <i>string2</i> corresponds to whitespace. The action label is in the format <i>number1.number2</i> . <i>number1</i> can be any number up to 16 digits. The range for <i>number2</i> is from 0 to 9.
action label string trimright <i>string1 [string2]</i> switch(config-applet)# action 5.7 string trimright "this is a testtest" "test"	Trims the characters in <i>string2</i> from the right end of <i>string1</i> . By default, <i>string2</i> corresponds to whitespace. The action label is in the format <i>number1.number2</i> . <i>number1</i> can be any number up to 16 digits. The range for <i>number2</i> is from 0 to 9.
action label set <i>variable-name variable-value</i> switch(config-applet)# action 6.0 set \$string "Container"	Sets the value of a variable. The action label is in the format <i>number1.number2</i> . <i>number1</i> can be any number up to 16 digits. The range for <i>number2</i> is from 0 to 9.

13.6.3 Defining a Policy Using a VSH Script

You can define a policy using a VSH script.

Before you begin

Ensure that you are logged in with administrator privileges.

Ensure that your script name is the same name as the script filename.

Procedure

-
- Step 1** In a text editor, list the commands that define the policy.
 - Step 2** Name the text file and save it.
 - Step 3** Copy the file to the following system directory: `bootflash://eem/user script policies`.
-

13.6.4 Registering and Activating a VSH Script Policy

You can register and activate a policy defined in a VSH script.

Procedure

	Command or Action	Purpose
Step 1	configure terminal Example: switch# configure terminal switch(config)#	Enters global configuration mode.
Step 2	event manager policy <i>policy-script</i> Example: switch(config)# event manager policy moduleScript	Registers and activates an EEM script policy. The <i>policy-script</i> can be any case-sensitive alphanumeric string up to 29 characters.
Step 3	show event manager policy internal <i>name</i> Example: switch(config)# show event manager policy internal moduleScript	(Optional) Displays information about the configured policy.
Step 4	copy running-config startup-config Example: switch(config)# copy running-config startup-config	(Optional) Copies the running configuration to the startup configuration.

13.6.5 Scheduling an EEM Policy

You can schedule an EEM policy that is registered and set the policy scheduling options.

Procedure

	Command or Action	Purpose
Step 1	configure terminal Example: switch# configure terminal switch(config)#	Enters the global configuration mode.
Step 2	event manager scheduler applet thread class	Schedules an EEM policy and sets the policy

	Command or Action	Purpose
	<i>class-options</i> number <i>thread-number</i> Example: switch(config)# event manager scheduler applet thread class default number 2	scheduling options like class and thread number for execution.
Step 3	event manager scheduler script thread class <i>class-options</i> range <i>class-range</i> number <i>thread-number</i> Example: switch(config)# event manager scheduler script thread class A B range D-E number 1	Schedules an EEM policy and sets the script scheduling options.
Step 4	event manager scheduler clear { all policy <i>job-id</i> queue-type applet [class <i>class-options</i>]} [processor { rp_primary rp_standby }] Example: switch# event manager scheduler clear policy 2	Clears the EEM policies that are currently executing or pending execution.
Step 5	event manager scheduler hold { all policy <i>job-id</i> queue-type applet [class <i>class-options</i>]} Example: switch# event manager scheduler hold policy 2	Holds a scheduled EEM policy event or event queue in the EEM scheduler.
Step 6	event manager scheduler modify { all policy <i>job-id</i> queue-type applet } { class <i>class-options</i> [queue-priority { high last low normal }] queue-priority { high last low normal } [class <i>class-options</i>]} Example: switch# event manager scheduler modify all class A	Modifies the scheduling parameters of the EEM policy.
Step 7	event manager scheduler release { all policy <i>policy-id</i> queue-type applet [class <i>class-options</i>]} Example: switch# event manager scheduler release all	Releases the EEM policies held through the event manager scheduler hold command.

13.6.6 Overriding a Policy

You can override a system policy.

Procedure

	Command or Action	Purpose
Step 1	configure terminal Example: switch# configure terminal switch(config)#	Enters global configuration mode.
Step 2	(Optional) show event manager policy-state <i>system-policy</i> Example:	Displays information about the system policy that you want to override, including thresholds. Use the show event manager system-policy

	Command or Action	Purpose
	switch(config-applet)# show event manager policy-state ethpm_link_flap Policy ethpm_link_flap Cfg count : 5 Cfg time interval : 10.000000 (seconds) Hash default, Count 0	command to find the system policy names.
Step 3	event manager applet <i>applet-name</i> override <i>system-policy</i> Example: switch(config)# event manager applet ethport override ethpm_link_flap switch(config-applet)#	Overrides a system policy and enters applet configuration mode. The <i>applet-name</i> can be any case-sensitive alphanumeric string up to 29 characters. The <i>system-policy</i> must be one of the existing system policies.
Step 4	(Optional) description <i>policy-description</i> Example: description "Overrides link flap policy."	Configures a descriptive string for the policy. The string can be any alphanumeric string up to 80 characters. Enclose the string in quotation marks.
Step 5	Required: event <i>event-statement</i> Example: switch(config-applet)# event policy-default count 2 time 1000	Configures the event statement for the policy.
Step 6	Required: action <i>number action-statement</i> Example: switch(config-applet)# action 1.0 syslog priority warnings msg "Link is flapping."	Configures an action statement for the policy. Repeat this step for multiple action statements.
Step 7	(Optional) show event manager policy-state <i>name</i> Example: switch(config-applet)# show event manager policy-state ethport	Displays information about the configured policy.
Step 8	(Optional) copy running-config startup-config Example: switch(config)# copy running-config startup- config	Copies the running configuration to the startup configuration.

13.6.7 Configuring Memory Thresholds

You can set the memory thresholds used to trigger events and set whether the operating system should kill processes if it cannot allocate memory.

Before you begin

Ensure that you are logged in with administrator privileges.

Procedure

	Command or Action	Purpose
Step 1	configure terminal Example: switch# configure terminal switch(config)#	Enters global configuration mode.
Step 2	system memory-thresholds <i>minor</i> <i>minor</i> severe <i>severe</i> critical <i>critical</i>	Configures the system memory thresholds that generate EEM memory events. The default values

	Command or Action	Purpose
	<p>Example: switch(config)# system memory-thresholds minor 60 severe 70 critical 80</p>	<p>are as follows:</p> <ul style="list-style-type: none"> • Minor-85 • Severe-90 • Critical-95 <p>When these memory thresholds are exceeded, the system generates the following syslogs:</p> <ul style="list-style-type: none"> • 2013 May 7 17:06:30 switch %\$ %PLATFORM-2-MEMORY_ALERT: Memory Status Alert : MINOR • 2013 May 7 17:06:30 switch %\$ %PLATFORM-2-MEMORY_ALERT: Memory Status Alert : SEVERE • 2013 May 7 17:06:30 switch %\$ %PLATFORM-2-MEMORY_ALERT: Memory Status Alert : CRITICAL • 2013 May 7 17:06:35 switch %\$ %PLATFORM-2-MEMORY_ALERT: Memory Status Alert : MINOR ALERT RECOVERED • 2013 May 7 17:06:35 switch %\$ %PLATFORM-2-MEMORY_ALERT: Memory Status Alert : SEVERE ALERT RECOVERED • 2013 May 7 17:06:35 switch %\$ %PLATFORM-2-MEMORY_ALERT: Memory Status Alert : CRITICAL ALERT RECOVERED
Step 3	<p>(Optional) system memory-thresholds threshold critical no-process-kill</p> <p>Example: switch(config)# system memory-thresholds threshold critical no-process-kill</p>	Configures the system to not kill processes when the memory cannot be allocated. The default value is to allow the system to kill processes, starting with the one that consumes the most memory.
Step 4	<p>(Optional) show running-config include "system memory"</p> <p>Example: switch(config-applet)# show running-config include "system memory"</p>	Displays information about the system memory configuration.
Step 5	<p>(Optional) copy running-config startup-config</p> <p>Example: switch(config)# copy running-config startup-config</p>	Copies the running configuration to the startup configuration.

13.6.8 Configuring Syslog as EEM Publisher

You can monitor syslog messages from the switch.

Before you begin

EEM should be available for registration by syslog. The syslog daemon must be configured and executed.

Procedure

	Command or Action	Purpose
Step 1	configure terminal Example: switch# configure terminal switch(config)#	Enters global configuration mode.
Step 2	event manager applet <i>applet-name</i> Example: switch(config)# event manager applet abc switch(config-applet)#	Registers an applet with EEM and enters applet configuration mode.
Step 3	event syslog [tag <i>tag</i>] { occurs <i>number</i> period <i>seconds</i> pattern <i>msg-text</i> priority <i>priority</i> } Example: switch(config-applet)# event syslog occurs 10	Monitors syslog messages and invokes the policy based on the search string in the policy. <ul style="list-style-type: none"> The tag <i>tag</i> keyword-argument pair identifies this specific event when multiple events are included in the policy. The occurs <i>number</i> keyword-argument pair specifies the number of occurrences. The range is from 1 to 65000. The period <i>seconds</i> keyword-argument pair specifies the interval during which the event occurs. The range is from 1 to 4294967295. The pattern <i>msg-text</i> keyword-argument pair specifies the matching regular expression. The pattern can contain character text, an environment variable, or a combination of the two. If the string contains embedded blanks, it is enclosed in quotation marks. The priority <i>priority</i> keyword-argument pair specifies the priority of the syslog messages. If this keyword is not selected, all syslog messages are set at the informational priority level.
Step 4	(Optional) copy running-config startup-config Example: switch(config)# copy running-config startup-config	Copies the running configuration to the startup configuration.

13.7 Verifying the EEM Configuration

To display EEM configuration information, use one of the following commands:

Command	Purpose
show event manager environment [<i>variable-name</i> all]	Displays information about the event manager environment variables.
show event manager event-types [<i>event</i> all module <i>slot</i>]	Displays information about the event manager event types.
show event manager history events [detail] [maximum <i>num-events</i>] [severity { catastrophic minor moderate severe }]	Displays the history of events for all policies.

Command	Purpose
show event manager policy internal [<i>policy-name</i>] [inactive]	Displays information about the configured policies.
show event manager policy-state <i>policy-name</i>	Displays information about the policy state, including thresholds.
show event manager script system [<i>policy-name</i> all]	Displays information about the script policies.
show event manager system-policy [all]	Displays information about the predefined system policies.
show running-config eem	Displays information about the running configuration for EEM.
show startup-config eem	Displays information about the startup configuration for EEM.
show event manager policy active [class <i>class-options</i> [detailed] [queue-type <i>applet</i>]]	Displays the EEM policies that are executing.
show event manager policy pending [class <i>class-options</i> [detailed] [queue-type <i>applet</i> [detailed]]]	Displays the policies that are pending for execution.
show event manager scheduler thread detailed	Displays the scheduled activities of the EEM policies.

13.8 Configuration Examples for EEM

This example shows how to override the `lcm_module_failure` system policy by changing the threshold for just module 3 hitless upgrade failures. This example also sends a syslog message. The settings in the system policy, `lcm_module_failure`, apply in all other cases.

```
event manager applet example2 override lcm_module_failure
event module-failure type hitless-upgrade-failure module 3 count 2
action 1 syslog priority errors msg module 3 "upgrade is not a hitless upgrade!"
action 2 policy-default
```

This example shows how to override the `ethpm_link_flap` system policy and shuts down the interface:

```
event manager applet ethport override ethpm_link_flap event
policy-default count 2 time 1000
action 1 cli conf t
action 2 cli int et1/1
action 3 cli no shut
```

This example creates an EEM policy that allows the CLI command to execute but triggers an SNMP notification when a user enters configuration mode on the device:

```
event manager applet TEST
event cli match "conf t"
action 1.0 snmp-trap strdata "Configuration change"
action 2.0 event-default
```

This example shows how to correlate multiple events in an EEM policy and execute the policy based on a combination of the event triggers. In this example, the EEM policy is triggered if one of the specified syslog patterns occurs within 120 seconds.

```
event manager applet eem-correlate
event syslog tag one pattern "copy bootflash:.* running-config.*"
event syslog tag two pattern "copy run start"
event syslog tag three pattern "hello"
tag one or two or three happens 1 in 120
action 1.0 reload module 1
```

This example shows how to monitor an interface shutdown with an EEM applet.

```
Devicek# sh run eem

!Command: show running-config eem
!Time: Thu Aug 24 00:21:17 2017

version 8.2(0)SK(1)
event manager applet E1
  event cli match "conf t ; interface * ; shutdown"
  action 1 syslog priority critical msg ""tracked interface shutdown" "
```

13.9 Related Documents

Related Topic	Document Title
EEM commands	<i>Inspur CN12700 Series INOS System Management Command Reference</i>
VDCs	<i>Inspur CN12700 Series INOS Virtual Device Context Configuration Guide</i>

13.10 Feature History for EEM

The table below summarizes the new and changed features for this document and shows the releases in which each feature is supported. Your software release might not support all the features in this document. For the latest caveats and feature information, the release notes for your software release.

Table 26 Feature History for EEM

Feature Name	Releases	Feature Information
EEM event correlation	5.2(1)	Added support for multiple event triggers in a single EEM policy.
Syslog as EEM publisher	5.1(1)	Added support to monitor syslog messages from the switch.
Memory thresholds configuration	4.1(3)	Added a configuration section for memory thresholds.

CHAPTER 14 Configuring Onboard Failure Logging

This chapter describes how to configure the onboard failure logging (OBFL) features on Inspur INOS devices. This chapter includes the following sections:

- Finding Feature Information
- About OBFL
- Virtualization Support
- Licensing Requirements for OBFL
- Prerequisites for OBFL
- Guidelines and Limitations for OBFL
- Default Settings for OBFL
- Configuring OBFL
- Verifying the OBFL Configuration
- Configuration Example for OBFL
- Additional References
- Feature History for OBFL

14.1 Finding Feature Information

Your software release might not support all the features documented in this module. For the latest caveats and feature information, the release notes for your software release. To find information about the features documented in this module, and to see a list of the releases in which each feature is supported, see the "New and Changed Information" chapter or the Feature History table in this chapter.

14.2 About OBFL

Inspur INOS provides the ability to log failure data to persistent storage, which you can retrieve and display for analysis at a later time. This onboard failure logging (OBFL) feature stores failure and environmental information in nonvolatile memory on the module. The information will help analyze failed modules.

OBFL stores the following types of data:

- Time of initial power-on
- Slot number of the module in the chassis
- Initial temperature of the module
- Firmware, BIOS, FPGA, and ASIC versions
- Serial number of the module
- Stack trace for crashes
- CPU hog information
- Memory leak information
- Software error messages
- Hardware exception logs
- Environmental history
- OBFL-specific history information
- ASIC interrupt and error statistics history
- ASIC register dumps

When you use the `show logging onboard internal xbar` command on a switch containing fabric modules, the output logs contain the hardware parameter values at that instance of time when the command is executed. Starting

from Inspur INOS Release 8.4(1), the show logging onboard internal xbar command output will also have logs from the specific time when data loss, if any, occurs. This enhancement will further help in debugging the error.

14.3 Virtualization Support

You must be in the default virtual device context (VDC) to configure and display OBFL information. See the *Inspur CN12700 Series INOS Virtual Device Context Configuration Guide* for more information on VDCs.

14.4 Licensing Requirements for OBFL

Product	License Requirement
Inspur INOS	OBFL requires no license. Any feature not included in a license package is bundled with the INOS image and is provided at no extra charge to you. For a complete explanation of the Inspur INOS licensing scheme, see the <i>Inspur INOS Licensing Guide</i> .

14.5 Prerequisites for OBFL

If you configure VDCs, install the appropriate license and enter the desired VDC. See the *Inspur CN12700 Series INOS Virtual Device Context Configuration Guide* for configuration information and the *Inspur INOS Licensing Guide* for licensing information.

You must have network-admin user privileges and be logged into the default VDC.

14.6 Guidelines and Limitations for OBFL

OBFL has the following guidelines and limitations:

- OBFL is enabled by default.
- OBFL flash supports a limited number of writes and erases. The more logging you enable, the faster you use up this number of writes and erases.

14.7 Default Settings for OBFL

The following table lists the default settings for OBFL parameters.

Parameters	Default
OBFL	All features enabled

14.8 Configuring OBFL

You can configure the OBFL features on Inspur INOS devices.

Before you begin

Make sure that you are in global configuration mode.

Procedure

	Command or Action	Purpose
Step 1	configure terminal Example: switch# configure terminal	Enters global configuration mode.

	Command or Action	Purpose
	switch(config)#	
Step 2	hw-module logging onboard Example: switch(config)# hw-module logging onboard Module: 7 Enabling ... was successful. Module: 10 Enabling ... was successful. Module: 12 Enabling ... was successful.	Enables all OBFL features.
Step 3	hw-module logging onboard counter-stats Example: switch(config)# hw-module logging onboard counter-stats Module: 7 Enabling counter-stats ... was successful. Module: 10 Enabling counter-stats ... was successful. Module: 12 Enabling counter-stats ... was successful.	Enables the OBFL counter statistics.
Step 4	hw-module logging onboard cpuhog Example: switch(config)# hw-module logging onboard cpuhog Module: 7 Enabling cpu-hog ... was successful. Module: 10 Enabling cpu-hog ... was successful. Module: 12 Enabling cpu-hog ... was successful.	Enables the OBFL CPU hog events.
Step 5	hw-module logging onboard environmental- history Example: switch(config)# hw-module logging onboard environmental-history Module: 7 Enabling environmental-history ... was successful. Module: 10 Enabling environmental-history ... was successful. Module: 12 Enabling environmental-history ... was successful.	Enables the OBFL environmental history.
Step 6	hw-module logging onboard error-stats Example: switch(config)# hw-module logging onboard error-stats Module: 7 Enabling error-stats ... was successful. Module: 10 Enabling error-stats ... was successful. Module: 12 Enabling error-stats ... was successful.	Enables the OBFL error statistics.
Step 7	hw-module logging onboard interrupt-stats Example: switch(config)# hw-module logging onboard interrupt-stats Module: 7 Enabling interrupt-stats ... was	Enables the OBFL interrupt statistics.

	Command or Action	Purpose
	successful. Module: 10 Enabling interrupt-stats ... was successful. Module: 12 Enabling interrupt-stats ... was successful.	
Step 8	hw-module logging onboard module slot Example: switch(config)# hw-module logging onboard module 7 Module: 7 Enabling ... was successful.	Enables the OBFL information for a module.
Step 9	hw-module logging onboard obfl-logs Example: switch(config)# hw-module logging onboard obfl-logs Module: 7 Enabling obfl-log ... was successful. Module: 10 Enabling obfl-log ... was successful. Module: 12 Enabling obfl-log ... was successful.	Enables the boot uptime, device version, and OBFL history.
Step 10	(Optional) show logging onboard Example: switch(config)# show logging onboard	Displays information about OBFL.
Step 11	(Optional) copy running-config startup-config Example: switch(config)# copy running-config startup-config	Copies the running configuration to the startup configuration.

14.9 Verifying the OBFL Configuration

To display OBFL information stored in flash on a module, perform one of the following tasks:

Command	Purpose
show logging onboard boot-uptime	Displays the boot and uptime information.
show logging onboard counter-stats	Displays statistics on all ASIC counters.
show logging onboard credit-loss	Displays OBFL credit loss logs.
show logging onboard device-version	Displays device version information.
show logging onboard endtime	Displays OBFL logs to a specified end time.
show logging onboard environmental-history	Displays environmental history.
show logging onboard error-stats	Displays error statistics.
show logging onboard exception-log	Displays exception log information.
show logging onboard interrupt-stats	Displays interrupt statistics.
show logging onboard internal xbar	Displays OBFL information for fabric modules.
show logging onboard module slot	Displays OBFL information for a specific module.
show logging onboard obfl-history	Displays history information.
show logging onboard obfl-logs	Displays log information.
show logging onboard stack-trace	Displays kernel stack trace information.
show logging onboard starttime	Displays OBFL logs from a specified start time.
show logging onboard status	Displays OBFL status information.

Use the show logging onboard status command to display the configuration status of OBFL.

```

switch# show logging onboard status
-----
OBFL Status
-----
Switch OBFL Log: Enabled

Module: 4 OBFL Log: Enabled
cpu-hog Enabled
credit-loss Enabled
environmental-history Enabled
error-stats Enabled
exception-log Enabled
interrupt-stats Enabled
mem-leak Enabled
miscellaneous-error Enabled
obfl-log (boot-uptime/device-version/obfl-history) Enabled
register-log Enabled
request-timeout Enabled
stack-trace Enabled
system-health Enabled
timeout-drops Enabled
stack-trace Enabled

Module: 22 OBFL Log: Enabled
cpu-hog Enabled
credit-loss Enabled
environmental-history Enabled
error-stats Enabled
exception-log Enabled
interrupt-stats Enabled
mem-leak Enabled
miscellaneous-error Enabled
obfl-log (boot-uptime/device-version/obfl-history) Enabled
register-log Enabled
request-timeout Enabled
stack-trace Enabled
system-health Enabled
timeout-drops Enabled
stack-trace Enabled

```

Use the clear logging onboard command to clear the OBFL information for each of the show command options listed.

14.10 Configuration Example for OBFL

This example shows how to enable OBFL on module 2 for environmental information:

```

switch# configure terminal
switch(config)# hw-module logging onboard module 2 environmental-history

```

14.11 Additional References

14.11.1 Related Documents

Related Topic	Document Title
OBFL CLI commands	<i>Inspur CNI2700 Series INOS System Management Command Reference</i>
Configuration files	<i>Inspur CNI2700 Series INOS Fundamentals Configuration Guide</i>
VDCs	<i>Inspur CNI2700 Series INOS Virtual Device Context Configuration Guide</i>

14.12 Feature History for OBFL

The table below summarizes the new and changed features for this document and shows the releases in which each feature is supported. Your software release might not support all the features in this document. For the latest caveats and feature information, the release notes for your software release.

Table 27 Feature History for OBFL

Feature Name	Releases	Feature Information
OBFL	4.0(1)	This feature was introduced.

CHAPTER 15 Configuring SPAN

This chapter describes how to configure an Ethernet switched port analyzer (SPAN) to analyze traffic between ports on Inspur INOS devices.

- Finding Feature Information
- About SPAN
- Licensing Requirements for SPAN
- Prerequisites for SPAN
- Guidelines and Limitations for SPAN
- Default Settings for SPAN
- Configuring SPAN
- Verifying the SPAN Configuration
- Configuration Examples for SPAN
- Related Documents
- Feature History for SPAN

15.1 Finding Feature Information

Your software release might not support all the features documented in this module. For the latest caveats and feature information, the release notes for your software release. To find information about the features documented in this module, and to see a list of the releases in which each feature is supported, see the "New and Changed Information" chapter or the Feature History table in this chapter.

15.2 About SPAN

SPAN analyzes all traffic between source ports by directing the SPAN session traffic to a destination port with an external analyzer attached to it.

You can define the sources and destinations to monitor in a SPAN session on the local device.

15.2.1 SPAN Sources

The interfaces from which traffic can be monitored are called SPAN sources. Sources designate the traffic to monitor and whether to copy ingress, egress, or both directions of traffic. SPAN sources include the following:

- Ethernet ports
- Port channels
- The inband interface to the control plane CPU
- VLANs (ingress only)—When a VLAN is specified as a SPAN source, all supported interfaces in the VLAN are SPAN sources.
 - Remote SPAN (RSPAN) VLANs
 - Fabric port channels connected to the Inspur CN3000 Series Fabric Extender (FEX)
 - Satellite ports and host interface port channels on the Inspur CN3000 Series Fabric Extender— These interfaces are supported in Layer 2 access mode, Layer 2 trunk mode, and Layer 3 mode.

15.2.1.1 Characteristics of Source Ports

SPAN source ports have the following characteristics:

- A port configured as a source port cannot also be configured as a destination port.
- An RSPAN VLAN cannot be used as a SPAN source.

- If you use the supervisor inband interface as a SPAN source, the following packets are monitored:
- All packets that arrive on the supervisor hardware (ingress)
- All packets generated by the supervisor hardware (egress)

15.2.2 SPAN Destinations

SPAN destinations refer to the interfaces that monitor source ports. Destination ports receive the copied traffic from SPAN sources.

15.2.2.1 Characteristics of Destination Ports

SPAN destination ports have the following characteristics:

- Destinations for a SPAN session include Ethernet ports or port-channel interfaces in either access or trunk mode.
- A port configured as a destination port cannot also be configured as a source port.
- A destination port can be configured in only one SPAN session at a time.
- Destination ports do not participate in any spanning tree instance. SPAN output includes bridge protocol data unit (BPDU) Spanning-Tree Protocol hello packets.
- All SPAN destinations configured for a given session receive all spanned traffic.
- An RSPAN VLAN cannot be used as a SPAN destination.
- You can configure SPAN destinations to inject packets to disrupt a certain TCP packet stream in support of the Intrusion Detection System (IDS).
 - You can configure SPAN destinations to enable a forwarding engine to learn the MAC address of the IDS.
- F Series module FabricPath core ports, Fabric Extender host interface (HIF) ports, HIF port channels, and fabric port-channel ports are not supported as SPAN destination ports.
- Shared interfaces cannot be used as SPAN destinations.
- VLAN ACL redirects to SPAN destination ports are not supported
- All SPAN destinations configured for a given session receive all spanned traffic.

15.2.3 SPAN Sessions

You can create SPAN sessions to designate sources and destinations to monitor.

See the *Inspur CN12700 Series INOS Verified Scalability Guide* for information on the number of supported SPAN sessions.

This figure shows a SPAN configuration. Packets on three Ethernet ports are copied to destination port Ethernet 2/5. Only traffic in the direction specified is copied.

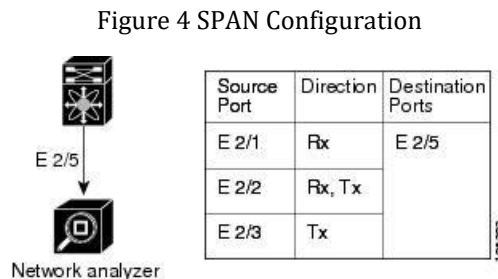

15.2.4 Extended SPAN Sessions

Inspur INOS Release 6.2(2) and later releases support extended SPAN sessions in addition to the two traditional SPAN sessions supported in prior releases. Extended SPAN sessions can be traditional or unidirectional. The session

direction is specified during session creation. A pool of 12 independent session resources are available. Unidirectional sessions use one resource, and traditional sessions use two resources. These 12 resources are shared between local and SPAN source sessions across all VDCs.

If you are configuring an extended SPAN session on a Inspur CN12710 switch the following applies:

- The mode extended command must be used with the third configuration session.
- You can configure 16 sessions as unidirectional or bidirectional, as required.
- You do not need to maintain two traditional sessions.
- You do not need to use the resource manager to reserve the two traditional sessions.

15.2.5 4K VLANs per SPAN Session

Inspur INOS Release 7.3(0)D1(1) and later releases support 4K VLANs per SPAN session. You can use the source interface all command to enable the monitor session on the switch to monitor all VLANs and ports in the VDC such as physical ports, Port Channels, FEX ports and FEX Port Channels. The 4K VLANs per SPAN Session feature also enables monitoring of a higher number of specific VLAN sources than the VLAN source limits currently supported in the monitor session by using the filter vlan command with the source interface all command to filter the irrelevant VLANs.

The 4K VLANs per SPAN Session feature has the following characteristics:

- This is not supported on M3 series modules.
- You will not be able to capture any traffic on the M3 Series modules in spite of configuring the source interface all command.
- You can use the source interface all command for multiple sessions in the same VDC.
- Supports all session parameters such as MTU truncation, Sampling and Rate Limiting.
- Simple and Complex Rule-based SPAN is supported with the source interface all command. This enables traffic flow-based monitoring using a set of filter rules across the VDC.
- Traffic generated by Supervisors is not spanned.
- Supported only in Ethernet VDCs of Inspur CN12700 Series switches.
- Supported only in extended SPAN sessions.

15.2.6 Rule-Based SPAN

Rule-based SPAN filters the ingress or egress SPAN traffic based on a set of rules. For Inspur INOS releases prior to 6.2(2), you can filter on VLANs, the destination index, and the source index. Beginning with Inspur INOS Release 6.2(2), you can filter the SPAN traffic based on a combination of fields in the Layer 2, Layer 3, or Layer 4 header packet.

Every SPAN session (traditional and extended) has an associated filter. Every SPAN session has one filter resource. A simple filter has only one rule, and you can add multiple fields or conditions to this rule. The packets are replicated only if all the conditions are met.

Table 28 Supported Filter Fields

Ethernet	IPv4	IPv6	ARP/RARP	FCoE
Frame Type	Frame Type	Frame Type	Frame Type	Frame Type
VLAN	VLAN	VLAN	VLAN	VLAN
TR	TR	TR	TR	TR
BPDU	BPDU	BPDU	BPDU	BPDU
Port Channel Lane	Port Channel Lane	Port Channel Lane	Port Channel Lane	Port Channel Lane
Flow Hash	Flow Hash	Flow Hash	Flow Hash	Flow Hash
L2 MAC DA	L2 MAC DA	L2 MAC DA	L2 MAC DA	L2 MAC DA
L2 MAC SA	L2 MAC SA	L2 MAC SA	L2 MAC SA	L2 MAC SA
EtherType	EtherType	EtherType	EtherType	EtherType
CoS/VL	CoS/VL	CoS/VL	CoS/VL	CoS/VL

Ethernet	IPv4	IPv6	ARP/RARP	FCoE
	CoS/VL ToS L4 Protocol IPv4 SA IPv4 DA	ToS L4 Protocol IPv6 SA IPv6 DA	CoS/VL ARP Request Sender IP Target IP	FCD_ID FCS_ID SOF R_CTL TYPE Cmd_Code

15.2.7 Exception SPAN

Exception SPAN enables you to span exception packets. Packets that have failed an intrusion detection system (IDS), Layer 3 IP verification, and FabricPath are treated as exception packets.

An exception SPAN session is supported in either one of the two traditional bidirectional SPAN sessions or in one of the extended SPAN sessions. Rate limiters, MTU truncation, and sampling are supported in the exception SPAN session. Only the exception packets sent to the drop destination interface are supported as a SPAN source. Exception packets that are pushed to the supervisor, ACLQoS, or Layer 2 are not spanned. Each VDC supports one exception SPAN session.

Extended SPAN is supported in the egress direction only. In the case of an extended SPAN Rx session, the exception source configuration will be rejected.

15.2.8 Virtual SPAN Sessions

You can create a virtual SPAN session to monitor multiple VLAN sources and choose only VLANs of interest to transmit on multiple destination ports. For example, you can configure SPAN on a trunk port and monitor traffic from different VLANs on different destination ports.

The figure below shows a virtual SPAN configuration. The virtual SPAN session copies traffic from the three VLANs to the three specified destination ports. You can choose which VLANs to allow on each destination port to limit the traffic that the device transmits on it. In the figure below, the device transmits packets from one VLAN at each destination port.

Figure 5 Virtual SPAN Configuration

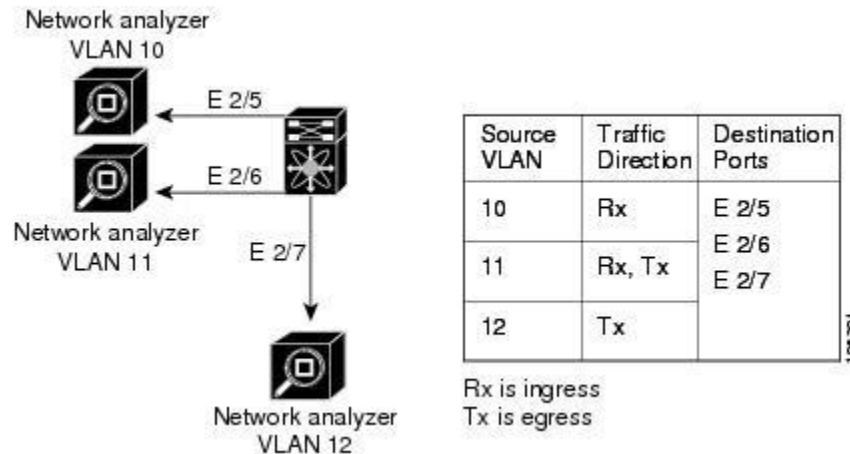

For information about configuring a virtual SPAN session see the Configuring a Virtual SPAN Session section.

15.2.9 Network Analysis Module

You can also use the Inspur Network Analysis Module (NAM) to monitor SPAN data sources for application performance, traffic analysis, and packet header analysis.

To use NAM for monitoring the Inspur CN12700 SPAN data sources, see the Inspur *CN12700 Series Network analysis Module (NAM-NXI) Quick Start Guide*.

15.2.10 High Availability

The SPAN feature supports stateless and stateful restarts. After a reboot or supervisor switchover, the running configuration is applied. For more information on high availability, see the Inspur *CN12700 Series INOS High Availability and Redundancy Guide*.

15.2.11 Virtualization Support

A virtual device context (VDC) is a logical representation of a set of system resources. SPAN applies only to the VDC where the commands are entered.

For information about configuring VDCs, see the Inspur *CN12700 Series INOS Virtual Device Context Configuration Guide*.

15.3 Licensing Requirements for SPAN

Product	License Requirement
Inspur INOS	SPAN requires no license. Any feature not included in a license package is bundled with the INOS image and is provided at no extra charge to you. For a complete explanation of the Inspur INOS licensing scheme, see the <i>Inspur INOS Licensing Guide</i> .

15.4 Prerequisites for SPAN

SPAN has the following prerequisites:

- You must first configure the ports on each device to support the desired SPAN configuration. For more information, see the Inspur *CN12700 Series INOS Interfaces Configuration Guide*.

15.5 Guidelines and Limitations for SPAN

15.5.1 General SPAN Guidelines and Limitations

- For SPAN session limits, see the *Inspur CN12700 Series INOS Verified Scalability Guide*.
- SPAN is not supported for management ports.
- All SPAN replication is performed in the hardware. The supervisor CPU is not involved.
- Link Aggregation Control Protocol (LACP) Port Channel is not supported as a SPAN destination.
- A destination port can only be configured in one SPAN session at a time.
- You cannot configure a port as both a source and destination port.
- If a module is not in the VDC in which the inband interface is sourced, packets destined to the supervisor cannot be captured.
 - For Inspur INOS releases prior to 6.1, you can monitor the inband interface only from the default VDC. Inband traffic from all VDCs is monitored. Beginning with Inspur INOS Release 6.1, the monitoring of the inband interface is no longer restricted to the default VDC:
 - Only users with the network admin privilege can add the inband interface as a SPAN source.
 - The inband interface can be added as a source from any VDC except the admin VDC, but at any time, only one VDC can have the inband interface as a source.

- Inband SPAN is treated as a shared resource. If a particular VDC does not have the resource allocated to it, inband port sourcing is rejected. Similarly, if a VDC that has the inband supervisor resource allocated to it removes the inband port from the source list of all monitor sessions, the inband resource is released from that VDC.
- For the supervisor inband interface, SPAN is supported only in the VDC in which the inband interface is sourced. If a module is part of a VDC in which the inband interface is not sourced, at least one interface of the module must be in the VDC in which the inband interface is sourced in order to capture supervisor inband packets from this module.
 - A single SPAN session can include mixed sources in any combination of the following:
 - Ethernet ports, but not subinterfaces
 - VLANs, that can be assigned to port channel subinterfaces
 - The inband interface to the control plane CPU
 - When a SPAN session contains both source interfaces and source VLAN clauses, there is a possibility that other VLANs also will be spanned.
- Destination ports do not participate in any spanning tree instance. SPAN output includes bridge protocol data unit (BPDU) Spanning-Tree Protocol hello packets.
- When a SPAN session contains source ports or VLAN sources that are monitored in the transmit or transmit and receive direction, packets that these ports receive might be replicated to the SPAN destination port even though the packets are not actually transmitted on the source ports. Some examples of this behavior on source ports are as follows:
 - Traffic that results from flooding
 - Broadcast and multicast traffic
 - You can enable SPAN for a source port before it becomes operationally active. Thus for Layer 2 ports, traffic flooded to the VLANs that contain these ports are captured even when the link is not connected for the ports.
- For VLAN SPAN sessions with both ingress and egress configured, two packets (one from ingress and one from egress) are forwarded from the destination port if the packets get switched on the same VLAN.
 - Beginning with Inspur INOS Release 6.2(2), the spanning of inband interfaces is as follows:
 - For Supervisor 1 systems, the two bidirectional traditional sessions can support an inband SPAN source.
 - For Supervisor 2 and Supervisor 2e systems, all the SPAN sessions can support an inband SPAN source.
 - Only one VDC can support inband SPAN at a time.
 - You can configure an RSPAN VLAN for use only as a SPAN session source.
 - You can configure a SPAN session on the local device only.
 - If you span a fabricpath core interface when inter-VLAN routing is enabled across Layer 2 multi-path (L2MP), it is not possible to capture the traffic egressing out of the core interface.
- SPAN is supported on Fabric Extender interfaces in Layer 2 access mode, Layer 2 trunk mode, and Layer 3 mode. Layer 3 subinterfaces are not supported.
 - Inspur INOS does not span Link Layer Discovery Protocol (LLDP) or Link Aggregation Control Protocol (LACP) packets when the source interface is a Fabric Extender HIF (downlink) port or HIF port channel.
 - SPAN sessions cannot capture packets with broadcast or multicast MAC addresses that reach the supervisor, such as ARP requests and Open Shortest Path First (OSPF) protocol hello packets, if the source of the session is the supervisor Ethernet in-band interface. To capture these packets, you must use the physical interface as the source in the SPAN sessions.
- The rate limit percentage of a SPAN session is based on 10G, 40G, and 100G for the respective modules (that is, 1 percent corresponds to 0.1G, 0.4G, or 1G respectively), and the value is applied per every forwarding engine instance.
 - Beginning with Inspur INOS Release 6.1, SPAN is supported for Supervisor 2.
 - SPAN does not capture pause frames in a Fibre Channel over Ethernet (FCoE) network because pause frames sent from the virtual expansion (VE) port are generated and terminated by the outermost MAC layer. For more information on FCoE, see the *Inspur INOS FCoE Configuration Guide for Inspur CN12700 and Inspur MDS 9500*.
 - On both Supervisor 1 and Supervisor 2, you cannot monitor the FCoE inband traffic.
 - You can monitor both ingress and egress FCoE traffic can be monitored in a local SPAN session through Ethernet interfaces, including shared interfaces, or VLANs. For shared interfaces, you can monitor the FCoE traffic

only in the storage VDC.

- The MAC in MAC (MiM) header in SPAN copies is preserved for the following SPAN destinations:
 - F2e modules with Release 6.2 or later releases.
 - F3 series modules with any Inspur INOS Release.
 - For F3 series modules with Release 6.2.(6a), 6.2.(6b), or 6.2(8), the Fabricpath (FP) header is preserved unconditionally. In Release 6.2.10, the FP header is preserved by default, but this behavior can be changed by using the **switchport monitor exclude header** command to remove the FP or VLAN tag header for a specified SPAN destination in a VDC or the **system default switchport monitor exclude header** command to remove the FP or VLAN tag header for all destination ports in the VDC. In Release 6.2.12, you can remove the FabricPath and VLAN tag headers using the **switchport monitor exclude header** command at the SPAN destination.
- The MiM header in SPAN copies is not preserved for the following SPAN destinations:
 - F1 and F2 series modules with any Inspur INOS Release.
 - F2e modules with Release 6.1(x).
 - For F3 series modules with Release 6.2.6, the FabricPath (FP) header is not preserved.

15.5.2 Guidelines and Limitations for F1 Series Module

• Prior to Inspur INOS Release 7.2(0)D1(1), multiple SPAN destinations are not supported when an F Series module is present in a VDC. If multiple SPAN destinations are configured in a SPAN session, the session is disabled until the F Series module is powered down or moved to another VDC or the multiple SPAN destinations are reduced to a single destination.

Starting from Inspur INOS Release 7.2(0)D1(1), multiple destination SPAN sessions are supported. Only the primary destination is used to transmit SPAN packets originated from Fx modules. Traffic from M series module goes to every destination port.

- A FabricPath core port is not supported as a SPAN destination when an F Series module is present in a VDC. However, a FabricPath core port can be configured as a SPAN source interface.
- F1 Series modules are Layer 2 domain modules. Packets from Layer 3 sources can be spanned and directed to an F1 Series module SPAN destination. An F1 Series module interface cannot be configured as Layer 3, but it can receive Layer 3 traffic in a SPAN destination mode.
- When using SPAN sessions on F1 Series or F2 Series modules, ensure that the total amount of source traffic in a given session is less than or equal to the capacity of the SPAN destination interface or port channel for that session. If the SPAN source traffic exceeds the capacity of the SPAN destination, packet drops might occur on the SPAN source interfaces. This guideline does not apply to F2e, F3 or M3 Series modules.
- MTU truncation and the SPAN rate limit are supported on F Series and M2 Series modules and Supervisor 2.
 - For F1 Series modules, MTU truncation on egress spanned FabricPath (core) packets has 16 fewer bytes than the configured value because the SPAN destination removes the core header. In addition, when trunk ports are used as the SPAN destination, the spanned ingress packets have 4 more bytes than the configured MTU truncation size.
 - For certain rate limit and packet size values on F Series modules, M2 Series modules, and Supervisor 2, the SPAN packet rate is less than the configured value because of the internal accounting of packet sizes and internal headers.
 - SPAN sampling is supported only on F Series modules.
 - Traditional SPAN sessions support traffic from the F Series and M Series modules. Extended SPAN sessions support traffic only from the F Series and M2 Series modules.
 - F1 Series modules have limited support for rule-based SPAN. They do not support IPv6 source IP and IPv6 destination IP filters. They support only IPv4 and IPv6 ToS filters with values from 0 to 3. Port channel member lane, FCoE source ID, and FCoE destination ID are not supported.

15.5.3 Guidelines and Limitations for F2/F2e Series Modules

- For certain rate limit and packet size values on F Series modules, M2 Series modules, and Supervisor 2, the SPAN packet rate is less than the configured value because of the internal accounting of packet sizes and internal headers.

- SPAN sampling is supported only on F Series modules.
- Traditional SPAN sessions support traffic from the F Series and M Series modules. Extended SPAN sessions support traffic only from the F Series and M2 Series modules.
- When the supervisor inband interface is monitored in the transmit direction on F2 Series modules, a 12-byte SHIM header is inserted after SMAC in SPAN packets.
- Prior to Inspur INOS Release 7.2(0)D1(1), multiple SPAN destinations are not supported when an F Series module is present in a VDC. If multiple SPAN destinations are configured in a SPAN session, the session is disabled until the F Series module is powered down or moved to another VDC or the multiple SPAN destinations are reduced to a single destination.

Starting from Inspur INOS Release 7.2(0)D1(1), multiple destination SPAN sessions are supported. Only the primary destination is used to transmit SPAN packets originated from Fx modules. Traffic from M series module goes to every destination port.

- A FabricPath core port is not supported as a SPAN destination when an F Series module is present in a VDC. However, a FabricPath core port can be configured as a SPAN source interface.
- SPAN source functionality on satellite ports and host interface port channels is not supported when the FEX is connected to F2 or F2e Series modules.
- When using SPAN sessions on F1 Series or F2 Series modules, ensure that the total amount of source traffic in a given session is less than or equal to the capacity of the SPAN destination interface or port channel for that session. If the SPAN source traffic exceeds the capacity of the SPAN destination, packet drops might occur on the SPAN source interfaces. This guideline does not apply to F2e, F3 or M3 Series modules.
- VLANs containing FEX interfaces can be a SPAN source, but the ingress traffic through the F2 Series module-based FEX ports cannot be captured.
- F2 Series modules support FEX, but they do not support FEX SPAN. Therefore, the FEX interfaces connected through the F2 Series modules cannot be made SPAN sources.
- You can span Fabric port channels on F2 Series modules.
- Layer 3 multicast egress packets cannot be spanned on F2 Series modules.
- MTU truncation and the SPAN rate limit are supported on F Series and M2 Series modules and Supervisor 2. These features are not supported on M1 Series modules.
- For F2 Series modules, ingress FEX packets spanned through the Fabric port channel have 6 fewer bytes than the configured MTU size because the VNTag header is removed on the SPAN destination.
- For F2 Series modules, egress SPAN packets of all traffic that ingresses on Layer 2 ports (including edge-to-edge traffic) have 16 fewer bytes than the configured MTU size because a MAC-in-MAC header is added internally and removed at the SPAN destination.
- For F2, F2e, and F3 Series modules using SPAN destination port channels, SPAN traffic is distributed among the member ports. However, the distribution pattern can be different from that of regular (non-SPAN destination) port channels. For example, you can have even load distribution for regular port channels but uneven load distribution (or no load balancing) for SPAN destination port channels.
- For certain rate limit and packet size values on F Series modules, M2 Series modules, and Supervisor 2, the SPAN packet rate is less than the configured value because of the internal accounting of packet sizes and internal headers.
- SPAN sampling is supported only on F Series modules. It is not supported on M Series modules.
- Beginning with Inspur INOS Release 6.1, FCoE SPAN on F2 Series modules is supported for storage VDCs.
- Hardware session 15 is used by NetFlow on F2 and F2e Series modules. Any extended session using this hardware ID will not span incoming traffic on the F2 and the F2e ports.
- F2 and F2e Series modules have limited support for rule-based SPAN. They do not support wildcards in the IPv6 source IP filter and IPv6 destination IP filter. They do not support egress SPAN filtering for destination MAC addresses and source MAC addresses.

15.5.4 Guidelines and Limitations for F3 Series Module

- For certain rate limit and packet size values on F Series modules, M2 Series modules, and Supervisor 2, the SPAN packet rate is less than the configured value because of the internal accounting of packet sizes and internal headers.

- SPAN sampling is supported only on F Series modules.
- Traditional SPAN sessions support traffic from the F Series modules. Extended SPAN sessions support traffic only from the F Series modules.
- Layer 3 multicast egress packets cannot be spanned on F3 Series modules.
- Prior to Inspur INOS Release 7.2(0)D1(1), multiple SPAN destinations are not supported when an F Series module is present in a VDC. If multiple SPAN destinations are configured in a SPAN session, the session is disabled until the F Series module is powered down or moved to another VDC or the multiple SPAN destinations are reduced to a single destination.

Starting from Inspur INOS Release 7.2(0)D1(1), multiple destination SPAN sessions are supported. Only the primary destination is used to transmit SPAN packets originated from Fx modules. Traffic from M series module goes to every destination port.

- MTU truncation and the SPAN rate limit are supported on F Series and Supervisor 2.
- A FabricPath core port is not supported as a SPAN destination when an F Series module is present in a VDC. However, a FabricPath core port can be configured as a SPAN source interface.
- F3 Series modules do not support wildcards in the IPv6 source IP filters and the IPv6 destination IP filters.

15.6 Default Settings for SPAN

The following table lists the default settings for SPAN parameters.

Parameters	Default
SPAN sessions	Created in the shut state
MTU truncation	Disabled
Multicast best effort mode	Disabled
SPAN rate limit for traditional SPAN sessions	Disabled
SPAN rate limit for extended SPAN sessions	Enabled
SPAN sampling	Disabled

15.7 Configuring SPAN

15.7.1 Configuring a SPAN Session

You can configure a SPAN session on the local device only. By default, SPAN sessions are created in the shut state.

For sources, you can specify Ethernet ports, port channels, the supervisor inband interface, and VLANs (ingress only).

A single SPAN session can include mixed sources in any combination of Ethernet ports, VLANs, or the inband interface to the control plane CPU. You cannot specify Ethernet port subinterfaces as sources for a SPAN session.

When you specify the supervisor inband interface for a SPAN source, the device monitors all packets that arrive on the supervisor hardware (ingress).

For destination ports, you can specify Ethernet ports or port channels in either access or trunk mode. You must enable monitor mode on all destination ports.

For bidirectional traditional sessions, you can configure the sessions without specifying the direction of the traffic.

For extended SPAN sessions, you can configure the sessions in one of the following ways:

- Configure a bidirectional session by not specifying any direction when you create the session and changing the mode to extended by entering the mode extended command.
- Configure a unidirectional session by specifying the traffic direction when you create the session.

Before you begin

Make sure you are in the correct VDC. To switch VDCs, use the `switchto vdc` command.

You must have already configured the destination ports in access or trunk mode. For more information, see the Inspur *CN12700 Series INOS Interfaces Configuration Guide*.

Procedure

	Command or Action	Purpose
Step 1	configure terminal Example: switch# configure terminal switch(config)#	Enters global configuration mode.
Step 2	interface ethernet <i>interface slot/port</i> Example: switch(config)# interface ethernet 2/5 switch(config-if)#	Enters interface configuration mode on the selected slot and port.
Step 3	switchport Example: switch(config-if)# switchport switch(config-if)#	Configures switchport parameters for the selected slot and port or range of ports.
Step 4	switchport mode [access trunk private-vlan] Example: switch(config-if)# switchport mode trunk switch(config-if)#	Configures switchport parameters for the selected slot and port or range of ports. <ul style="list-style-type: none"> • access • trunk • private-vlan
Step 5	switchport monitor [ingress [learning]] Example: switch(config-if)# switchport monitor	Configures the switchport interface as a SPAN destination: <ul style="list-style-type: none"> • ingress—Allows the SPAN destination port to inject packets that disrupt a certain TCP packet stream, for example, in networks with IDS. • ingress learning—Allows the SPAN destination port to inject packets, and allows the learning of MAC addresses, for example, the IDS MAC address.
Step 6	(Optional) Repeat Steps 2 and 3 to configure monitoring on additional SPAN destinations	—
Step 7	no monitor session <i>session-number</i> Example: switch(config)# no monitor session 3	Clears the configuration of the specified SPAN session. The new session configuration is added to the existing session configuration.
Step 8	monitor session <i>session-number</i> [shut] Example: switch(config)# monitor session 3 rx switch(config-monitor)# Example: switch(config)# monitor session 3 tx switch(config-monitor)#	Clears the configuration of the specified SPAN session. The new session configuration is added to the existing session configuration. Enters the monitor configuration mode. The new session configuration is added to the existing session configuration. By default, the session is created in the shut state, and the session is a

	Command or Action	Purpose
	<p>Example: switch(config)# monitor session 3 shut switch(config-monitor)#</p>	<p>local SPAN session. The optional keywords are as follows:</p> <ul style="list-style-type: none"> • rx—Specifies an ingress extended SPAN session. • tx—Specifies an egress extended SPAN session. • shut—Specifies a shut state for the selected session.
Step 9	<p>mode extended Example: switch(config-monitor)# mode extended</p>	<p>(Optional) Configures the SPAN session as an extended bidirectional session. Note You cannot use this command for a unidirectional SPAN session.</p>
Step 10	<p>description<i>description</i> Example: switch(config-monitor)# description my span session 3</p>	<p>Configures a description for the session. By default, no description is defined. The description can be up to 32 alphanumeric characters.</p>
Step 11	<p>source {interface {all <i>type</i>} vlan {<i>number</i> <i>range</i>}} [rx tx both] Example: switch(config-monitor)# source interface ethernet 2/1-3, ethernet 3/1 rx Example: switch(config-monitor)# source interface port-channel 2 Example: switch(config-monitor)# source interface sup-eth 0 both Example: switch(config-monitor)# source vlan 3, 6-8 rx Example: switch(config-monitor)# source interface ethernet 101/1/1-3 Example: switch(config-monitor)# source interface all rx</p>	<p>Configures sources and the traffic direction in which to copy packets. You can enter a range of Ethernet ports, a port channel, an inband interface, a range of VLANs, a Inspur CN3000 Series Fabric Extender interface, or a fabric port channel connected to a Inspur CN3000 Series Fabric Extender.</p> <p>You can configure one or more sources, as either a series of comma-separated entries or a range of numbers. You can specify up to 128 interfaces. The VLAN range is from 1 to 3967. The VLAN range of 4048 to 4093 is also supported for Inspur INOS releases prior to 6.1. You can specify the traffic direction to copy as ingress (rx), egress (tx), or both. By default, the direction is both. For a unidirectional session, the direction of the source must match the direction specified in the session.</p> <p>Beginning with Inspur INOS Release 7.3(0)D1(1), you can use the all keyword to enable the monitor session to monitor all VLANs and ports in the VDC such as physical ports, Port Channels, FEX ports and FEX Port Channels. The all keyword is supported only in Extended SPAN sessions.</p>
Step 12	<p>(Optional) Repeat Step 11 to configure all SPAN sources.</p>	—
Step 13	<p>(Optional) filter vlan {<i>number</i> <i>range</i>} [include-untagged] Example: switch(config-monitor)# filter vlan 3-5, 7</p>	<p>(Optional) Configures which VLANs to select from the configured sources. You can configure one or more VLANs, as either a series of comma-separated entries, or a range of numbers. The VLAN range is from 1 to 3967. The VLAN range of 4048 to 4093 is also supported for Inspur INOS releases prior to 6.1.</p>

	Command or Action	Purpose
		The include-untagged keyword applies a VLAN access map to one or more VLANs and includes untagged frames on a port with Layer 3 subinterfaces. You can enable monitoring of a higher number of specific VLAN sources than the VLAN source limits currently supported in extended SPAN monitor session by using the filter vlan command with the source interface all command to filter the irrelevant VLANs.
Step 14	(Optional) Repeat Step 13 to configure all source VLANs to filter.	—
Step 15	Required: destination interface type {number range} Example: switch(config-monitor)# destination interface ethernet 2/5, ethernet 3/7	Configures destinations for copied source packets. You can configure one or more destinations as either a series of comma-separated entries or a range of numbers. You can specify up to 128 interfaces. Note SPAN destination ports must be either access or trunk ports. Note The Inspur CN3000 Series Fabric Extender interfaces and the fabric port channels connected to the Inspur CN3000 Series Fabric Extender cannot be configured as SPAN destinations.
Step 16	(Optional) Repeat Step 15 to configure all SPAN destination ports.	—
Step 17	Required: no shut Example: switch(config-monitor)# no shut	Enables the SPAN session. By default, the session is created in the shut state.
Step 18	(Optional) show monitor session {all session-number range session-range} [brief] Example: switch(config-monitor)# show monitor session 3	Displays the SPAN configuration.
Step 19	(Optional) copy running-config startup-config Example: switch(config)# copy running-config startup-config	Copies the running configuration to the startup configuration.

15.7.2 Configuring Multi-Destination SPAN on F2 Series Modules

If you are configuring a multiple destination port for a SPAN session on a Inspur CN12700 switch, do the following:

- Remove the module type restriction when configuring multiple SPAN destination port to allow a SPAN session.
 - Designate a primary destination port for VDCs with any Fx module or supervisor to activate a SPAN session.
- For sources, you can specify ports, VLANs, or RSPAN VLANs.

Before you begin

Multiple destination SPAN sessions were not supported in VDCs with F-series modules (F1/F2/F2E/F3), and hence even if the sessions were configured, they were not enabled in the VDCs. Starting from Inspur INOS Release

7.2, multiple destination SPAN sessions are supported. The primary destination is used to transmit SPAN packets originated from Fx modules.

BEFORE YOU BEGIN

Ensure that you are in the correct VDC (or use the switch to vdc command).

Procedure

	Command or Action	Purpose
Step 1	configure terminal Example: switch# configure terminal switch(config)#	Enters global configuration mode.
Step 2	no monitor session <i>session-number</i> Example: switch(config)# no monitor session 3	Clears the configuration of the specified SPAN session. The new session configuration is added to the existing session configuration.
Step 3	monitor session <i>session-number</i> Example: switch(config)# monitor session 4 rx switch(config-monitor)# Example: switch(config)# monitor session 3 tx switch(config-monitor)#	Enters the monitor configuration mode. The new session configuration is added to the existing session configuration, which specifies the SPAN session for which the source rate limit is to be configured. By default, the session is created in the shut state, and the session is a local SPAN session.
Step 4	source { interface <i>type</i> vlan { <i>number</i> <i>range</i> }} [rx tx both] Example: switch(config-monitor)# source interface ethernet 2/1-3, ethernet 3/1 rx	Configures sources and the traffic direction in which to copy packets. You can enter a range of Ethernet ports, a port channel, an inband interface, or a range of VLANs. You can configure one or more sources, as either a series of comma-separated entries or a range of numbers. You can specify up to 128 interfaces. You can specify the traffic direction to copy as ingress (rx), egress (tx), or both. By default, the direction is both. Note Source VLANs are supported only in the ingress (rx) direction.
Step 5	(Optional) Repeat Step 4 to configure all virtual SPAN VLAN sources.	—
Step 6	Required: destination interface <i>type</i> { <i>number</i> <i>range</i> } [primary] Example: switch(config-monitor)# destination interface ethernet 2/5, ethernet 3/7 primary	Configures destinations for copied source packets. You can configure one or more destinations as either a series of comma-separated entries or a range of numbers. However, only one such primary port can be configured in a session. You can specify up to 128 interfaces. Note SPAN destination ports must be either access or trunk ports.
Step 7	Required: no rate-limit Example: switch(config-monitor)# no rate limit	Sets the rate limit for the SPAN traffic.

	Command or Action	Purpose
Step 8	Required: no destination interface <i>type</i> { <i>number</i> <i>range</i> } [primary] Example: switch(config-monitor)# destination interface ethernet 2/5, ethernet 3/7 primary	Checks the configuration to ensure that the primary attribute is not configured on the destination port. Displays an error message if more than one port is configured. Note ERROR: Cannot configure more than one "Primary" destination port in a session.
Step 9	(Optional) Repeat Step 12 to configure all source VLANs to filter.	—
Step 10	Required: no shut Example: switch(config-monitor)# no shut	Enables the SPAN session. By default, the session is created in the shut state.
Step 11	(Optional) show monitor session {all <i>session-number</i> range <i>session-range</i> } [brief] Example: switch(config-monitor)# show monitor session 3	Displays the SPAN configuration.
Step 12	(Optional) copy running-config startup-config Example: switch(config)# copy running-config startup-config	Copies the running configuration to the startup configuration.

15.7.3 Configuring Multiple SPAN Sessions on a SPAN Destination Port

BEFORE YOU BEGIN

Ensure that you are in the correct VDC (or use the switch to vdc command).

Before you begin

With the introduction of multiple SPAN sessions, it is important to share the destination interface across multiple SPAN sessions, which not only reduce the CN127 hardware cost of the SPAN sessions and the traffic monitoring equipment, it can also simplify the overall network connections.

- Rate limiter 'auto' mode is not allowed with span session(s) having shared span destination port(s).
- The 'manual' mode is recommended when the rate limit is required for individual SPAN session.

Procedure

	Command or Action	Purpose
Step 1	configure terminal Example: switch# configure terminal switch(config)#	Enters global configuration mode.
Step 2	monitor session <i>session-number</i> [<i>session-type</i>] Example: switch(config)# monitor session 3 span switch(config-monitor)#	Enters the monitor configuration mode and specifies a SPAN session.
Step 3	Required: destination interface { ethernet <i>x/y</i> port-channel <i>z</i> } Example: switch(config-monitor)# destination interface ethernet1/2	(Optional) Specifies the option to add a destination port. Note Rate limit auto should be disabled for sharing SPAN destination ports across multiple sessions. However, if the rate limit auto is enabled for a destination

	Command or Action	Purpose
		port and the destination port is already used in any other SPAN session, there will be a request to disable the auto mode first.
Step 4	Required: no rate-limit { auto rate-value } Example: switch(config-monitor-local)# no rate-limit auto	(Optional) Enables the rate limit. Note Auto rate limit should be disabled for sharing SPAN destination ports across multiple sessions. If a shared destination port is configured in the span session, the CLI gets rejected until you remove the shared destination port.

15.7.4 Configuring a Virtual SPAN Session

You can configure a virtual SPAN session to copy packets from source ports, VLANs, and RSPAN VLANs to destination ports on the local device. By default, SPAN sessions are created in the shut state.

For sources, you can specify ports, VLANs, or RSPAN VLANs.

Before you begin

Ensure that you are in the correct VDC (or use the `switchto vdc` command).

You have already configured the destination ports in trunk mode. For more information, see the Inspur CN12700 Series INOS Interfaces Configuration Guide.

You have already configured the destination ports to monitor a SPAN session with the `switchport monitor` command.

Procedure

	Command or Action	Purpose
Step 1	configure terminal Example: switch# configure terminal switch(config)#	Enters global configuration mode.
Step 2	no monitor session <i>session-number</i> Example: switch(config)# no monitor session 3	Clears the configuration of the specified SPAN session. The new session configuration is added to the existing session configuration.
Step 3	monitor session <i>session-number</i> Example: switch(config)# monitor session 3 rx switch(config-monitor)# Example: switch(config)# monitor session 3 tx switch(config-monitor)# Example: switch(config)# monitor session 3 shut switch(config-monitor)#	Enters the monitor configuration mode. The new session configuration is added to the existing session configuration. By default, the session is created in the shut state, and the session is a local SPAN session. The optional keyword <code>shut</code> specifies a shut state for the selected session.
Step 4	source { interface <i>type</i> vlan { <i>number</i> <i>range</i> }} [rx tx both] Example: switch(config-monitor)# source interface ethernet	Configures sources and the traffic direction in which to copy packets. You can enter a range of Ethernet ports, a port channel, an inband interface, or a range of VLANs.

	Command or Action	Purpose
	2/1-3, ethernet 3/1 rx Example: switch(config-monitor)# source interface port-channel 2 Example: switch(config-monitor)# source interface sup-eth 0 both Example: switch(config-monitor)# source vlan 3, 6-8 rx Example: switch(config-monitor)# source interface ethernet 101/1/1-3	You can configure one or more sources, as either a series of comma-separated entries or a range of numbers. You can specify up to 128 interfaces. You can specify the traffic direction to copy as ingress (rx), egress (tx), or both. By default, the direction is both. Note Source VLANs are supported only in the ingress (rx) direction. For a unidirectional session, the direction of the source must match the direction specified in the session.
Step 5	(Optional) Repeat Step 4 to configure all virtual SPAN VLAN sources.	—
Step 6	Required: destination interface type {number range} Example: switch(config-monitor)# destination interface ethernet 2/5, ethernet 3/7	Configures destinations for copied source packets. You can configure one or more destinations as either a series of comma-separated entries or a range of numbers. You can specify up to 128 interfaces. Note SPAN destination ports must be either access or trunk ports.
Step 7	(Optional) Repeat Step 12 to configure all source VLANs to filter.	—
Step 8	Required: no shut Example: switch(config-monitor)# no shut	Enables the SPAN session. By default, the session is created in the shut state.
Step 9	(Optional) show monitor session {all session-number range session-range} [brief] Example: switch(config-monitor)# show monitor session 3	Displays the SPAN configuration.
Step 10	Required: interface ethernet slot/port [port] Example: switch(config)# interface ethernet 2/5 switch(config-if)#	Enters interface configuration mode on the selected slot and port or range of ports.
Step 11	(Optional) switchport trunk allowed vlan {all session-number range session-range} [brief] Example: switch(config-monitor)# show monitor session 3	Configures the range of VLANs that are allowed on the interface. You can add to or remove from the existing VLANs, you can select all VLANs except those VLANs that you specify, or you can select all or none of the VLANs. By default, all VLANs are allowed on the interface. You can configure one or more VLANs as either a series of comma-separated entries or a range of numbers. The VLAN range is from 1 to 3967. The VLAN range of 4048 to 4093 is also supported for Inspur INOS releases prior to 6.1.
Step 12	(Optional) Repeat Steps 10 and 11 to configure the allowed VLANs on each destination port.	
Step 13	(Optional) show interface ethernet Example:	(Optional) Displays the interface trunking configuration for the selected slot and port or

	Command or Action	Purpose
	switch(config)# interface ethernet 2/5 switch(config-if)#	range of ports.
Step 14	(Optional) copy running-config startup-config Example: switch(config)# copy running-config startup-config	Copies the running configuration to the startup configuration.

15.7.5 Configuring an RSPAN VLAN

You can specify a remote SPAN (RSPAN) VLAN as a SPAN session source.

Before you begin

Ensure that you are in the correct VDC (or use the `switchto vdc` command).

Procedure

	Command or Action	Purpose
Step 1	configure terminal Example: switch# configure terminal switch(config)#	Enters global configuration mode.
Step 2	vlan vlan Example: switch(config)# vlan 901 switch(config-vlan)#	Enters VLAN configuration mode for the VLAN specified.
Step 3	remote-span Example: switch(config-vlan)# remote-span	Configures the VLAN as an RSPAN VLAN.
Step 4	exit Example: switch(config-vlan)# exit switch(config)#	Exits VLAN configuration mode.
Step 5	(Optional) show vlan Example: switch(config)# show vlan	(Optional) Displays the VLAN configuration. Remote SPAN VLANs are listed together.
Step 6	(Optional) copy running-config startup-config Example: switch(config)# copy running-config startup-config	(Optional) Copies the running configuration to the startup configuration.

15.7.6 Shutting Down or Resuming a SPAN Session

You can shut down SPAN sessions to discontinue the copying of packets from sources to destinations. You can shut down one session in order to free hardware resources to enable another session. By default, SPAN sessions are created in the shut state.

You can resume (enable) SPAN sessions to resume the copying of packets from sources to destinations. In order to enable a SPAN session that is already enabled but operationally down, you must first shut it down and then enable it.

You can configure the shut and enabled SPAN session states with either a global or monitor configuration mode command.

Procedure

	Command or Action	Purpose
Step 1	configure terminal Example: switch# configure terminal switch(config)#	Enters global configuration mode.
Step 2	[no] monitor session {<i>session-range</i> all} shut Example: switch(config)# monitor session 3 shut	Shuts down the specified SPAN sessions. By default, sessions are created in the shut state. The no form of the command resumes (enables) the specified SPAN sessions. By default, sessions are created in the shut state. Note If a monitor session is enabled but its operational status is down, to enable the session, you must first specify the monitor session shut command followed by the no monitor session shut command.
Step 3	monitor session <i>session-number</i> Example: switch(config)# monitor session 3 switch(config-monitor)#	Enters the monitor configuration mode. The new session configuration is added to the existing session configuration.
Step 4	[no] shut Example: switch(config-monitor)# shut	Shuts down the SPAN session. By default, the session is created in the shut state. The no form of the command enables the SPAN session. By default, the session is created in the shut state.
Step 5	(Optional) show monitor Example: switch(config-monitor)# show monitor	Displays the status of SPAN sessions.
Step 6	(Optional) copy running-config startup-config Example: switch(config)# copy running-config startup-config	Copies the running configuration to the startup configuration.

15.7.7 Configuring MTU Truncation for Each SPAN Session

To reduce the SPAN traffic bandwidth, you can configure the maximum bytes allowed for each replicated packet in a SPAN session. This value is called the maximum transmission unit (MTU) truncation size. Any SPAN packet larger than the configured size is truncated to the configured size.

Before you begin

Ensure that you are in the correct VDC (or use the `switchto vdc` command).

Procedure

	Command or Action	Purpose
Step 1	configure terminal Example: switch# configure terminal switch(config)#	Enters global configuration mode.

	Command or Action	Purpose
Step 2	monitor session <i>session-number</i> Example: switch(config)# monitor session 3 switch(config-monitor)#	Enters the monitor configuration mode and specifies the SPAN session for which the MTU truncation size is to be configured.
Step 3	Required: [no] mtu <i>mtu</i> Example: switch(config-monitor)# mtu 64	Configures the MTU truncation size for packets in the specified SPAN session. The range is from 64 to 1500 bytes.
Step 4	show monitor session <i>session-number</i> Example: switch(config)# monitor session 3 switch(config-monitor)#	(Optional) Displays the status of SPAN sessions, including the configuration status of MTU truncation, the maximum bytes allowed for each packet per session, and the modules on which MTU truncation is and is not supported.
Step 5	(Optional) copy running-config startup-config Example: switch(config)# copy running-config startup-config	Copies the running configuration to the startup configuration.

15.7.8 Configuring a Source Rate Limit for Each SPAN Session

When a SPAN session is configured with multiple interfaces or VLANs as the sources in a high-traffic environment, the destination port can be overloaded, causing the normal data traffic to be disrupted at the source port. You can alleviate this problem as well as traffic overload on the source forwarding instance by configuring a source rate limit for each SPAN session.

Before you begin

Ensure that you are in the correct VDC (or use the `switchto vdc` command).

Procedure

	Command or Action	Purpose
Step 1	configure terminal Example: switch# configure terminal switch(config)#	Enters global configuration mode.
Step 2	monitor session <i>session-number</i> Example: switch(config)# monitor session 3 switch(config-monitor)#	Enters the monitor configuration mode and specifies the SPAN session for which the source rate limit is to be configured.
Step 3	Required: [no] rate-limit {auto rate-limit} Example: switch(config-monitor)# rate-limit auto	Configures the source rate limit for SPAN packets in the specified SPAN session in automatic or manual: <ul style="list-style-type: none"> Auto mode—Automatically calculates the rate limit on a per-gigabyte basis as follows: destination bandwidth / aggregate source bandwidth. For example, if the rate limit per gigabyte is 0.5, for every 1G of source traffic, only 0.5G of packets are spanned. For ingress traffic, the per-gigabyte limit is applied to each forwarding engine of the F Series

	Command or Action	Purpose
		<p>module based on how many ports are used as the SPAN source so that the source can be spanned at the maximum available bandwidth. For egress traffic, the per-gigabyte limit is applied to each forwarding engine of the F Series module without considering how many ports are used as the SPAN source.</p> <ul style="list-style-type: none"> Manual mode—Specifies the percentage of the maximum rate of SPAN packets that can be sent out from each forwarding engine on a module. The range is from 1 to 100. For example, if the rate limit is 10 percent, the maximum rate of SPAN packets that can be sent out from each of the forwarding engines on an F Series module is 1G (or 10 percent of the 10G line rate).
Step 4	<p>show monitor session <i>session-number</i></p> <p>Example: switch(config)# monitor session 3 switch(config-monitor)#</p>	(Optional) Displays the status of SPAN sessions, including the configuration status of the rate limit, the percentage of the maximum SPAN rate allowed per session, and the modules on which the rate limit is and is not supported.
Step 5	<p>(Optional) copy running-config startup-config</p> <p>Example: switch(config)# copy running-config startup-config</p>	Copies the running configuration to the startup configuration.

15.7.9 Configuring Sampling for Each SPAN Session

Beginning with Inspur INOS Release 6.1, you can configure a sampling range for spanned traffic in order to reduce the SPAN traffic bandwidth and to monitor peer-to-peer traffic. Packet range-based sampling is used to provide an accurate count of the SPAN source packets.

Before you begin

Ensure that you are in the correct VDC (or use the `switchto vdc` command).

Procedure

	Command or Action	Purpose
Step 1	<p>configure terminal</p> <p>Example: switch# configure terminal switch(config)#</p>	Enters global configuration mode.
Step 2	<p>monitor session <i>session-number</i></p> <p>Example: switch(config)# monitor session 3 switch(config-monitor)#</p>	
Step 3	<p>monitor session <i>session-number</i> [<i>rt</i> <i>tx</i>] [<i>shut</i>]</p> <p>Example: switch(config-monitor)# sampling 100</p>	Configures the sampling range for SPAN source packets. The sampling value is the range in which one packet out of x packets will be spanned,

	Command or Action	Purpose
		where x is from 2 to 1023. In this example, 1 out of every 100 packets will be spanned.
Step 4	(Optional) show monitor session {all <i>session-number</i> range <i>session-range</i> } [brief] Example: switch(config-monitor)# show monitor session 3	Displays the status of SPAN sessions, including the configuration status of SPAN sampling, the sampling value, and the modules on which sampling is and is not supported.
Step 5	(Optional) copy running-config startup-config Example: switch(config)# copy running-config startup-config	Copies the running configuration to the startup configuration.

15.7.10 Complex Rule-based SPAN

Before you begin

Complex filter rules can be created with multiple filters and product table resources. A few keywords, Match, Permit, Deny and Filter-list have been introduced in this release. The "Match" keyword helps to match on the fields and values set by the user. "Permit" keyword followed by the filter names allow a SPAN copy to be generated if all filters are hit. "Deny" keyword followed by the filter names allow a SPAN copy to be generated if all the filters are missed. "Filter-list" is a keyword that specifies all the rules defined by the permit and deny keywords.

15.7.10.1 Creating Filters

BEFORE YOU BEGIN

Ensure that you are in the correct VDC (or use the switchto vdc command).

Procedure

	Command or Action	Purpose
Step 1	configure terminal Example: switch# configure terminal switch(config)#	Enters global configuration mode.
Step 2	monitor filter <i>filter-name</i> Example: switch(config)# monitor filter test-filter switch(config-monitor-filter)#	Enters the monitor filter configuration mode. Note The length of the string should not exceed 32 characters.
Step 3	match [eth-type <i>eth-type</i> src-mac <i>mac-address mac-mask</i> dest-mac <i>mac-address mac-mask</i> frame-type [<i>arp</i> <i>eth</i> <i>fcoe</i> <i>ipv4</i> <i>ipv6</i>] Example: switch(config-monitor-filter)# match eth-type 0x0800 switch(config-monitor-filter)# match src-mac 40:55:39:0c:98:c1 ff:ff:ff:ff:ff:00 dest-mac 40:55:39:0c:98:c1 ff:ff:ff:ff:ff:00	Match specific fields in the packet under monitor filter configuration mode. Note Specifying match criteria in the same line or in multiple lines will have the same result.

15.7.10.2 Creating Filter-Lists

BEFORE YOU BEGIN

Ensure that you are in the correct VDC (or use the `switchto vdc` command).

Procedure

	Command or Action	Purpose
Step 1	configure terminal Example: switch# configure terminal switch(config)#	Enters global configuration mode.
Step 2	monitor filter-list <i>filter-list-name</i> Example: switch(config)# monitor filter-list sample-filter-list switch(config-monitor-filter-list)#	Enters the monitor filter configuration mode. Note The length of the string should not exceed 32 characters.
Step 3	permit filter <i>filter-names</i> deny filter <i>filter-names</i> Example: switch(config-monitor-filter-list)# permit filter test-filter deny filter test-filter1 switch(config-monitor-filter-list)# switch(config-monitor-filter-list)# permit filter test-filter2 switch(config-monitor-filter-list)# switch(config-monitor-filter-list)# deny filter test-filter3 switch(config-monitor-filter-list)#	Use this command to permit and/or deny filters within the filter-list. Note <ul style="list-style-type: none"> When the command permit filter <i>filter-names</i> deny filter <i>filter-names</i> is specified in the same line, the rule matches all permit and deny criteria, where packets matching filter x and filter y in permit filter X and deny filter Y are SPAN-ed—this is an AND condition. When the command permit filter <i>filter-names</i> deny filter <i>filter-names</i> is specified in separate lines, the rule matches either permit or deny criteria, where packets match filter x OR filter y in permit filter X and deny filter Y are SPAN-ed—it is an OR condition.

15.7.10.3 Associating a Filter List to a Monitor Session**BEFORE YOU BEGIN**

Ensure that you are in the correct VDC (or use the `switchto vdc` command).

Procedure

	Command or Action	Purpose
Step 1	configure terminal Example: switch# configure terminal switch(config)#	Enters global configuration mode.
Step 2	monitor session <i>session-number</i> [<i>rt</i> <i>tx</i>] Example: switch(config)# monitor session 3 rx switch(config-monitor)# filter filter-list sample-filter-list	Enters the monitor configuration mode and specifies the SPAN session. The optional keywords are as follows: <ul style="list-style-type: none"> <i>rx</i>—Specifies an ingress extended SPAN session. <i>tx</i>—Specifies an egress extended SPAN

	Command or Action	Purpose
		session. Note <ul style="list-style-type: none"> • If you are attaching a filter-list to a SPAN session on a Inspur CN12700 series switch, then the mode extended command should be specified within the SPAN session. • The direction of the filter is derived from the SPAN session direction.
Step 3	exit Example: switch(config-monitor)# exit	Returns to the global configuration mode.

15.7.10.4 Configuring a Session with Rules Enabled

To create a local/erspan-source unidirectional/bidirectional session, configure the following:

Procedure

	Command or Action	Purpose
Step 1	configure terminal Example: switch# configure terminal switch(config)#	Enters global configuration mode.
Step 2	monitor session <i>session-number</i> [<i>rt</i> <i>tx</i>] [<i>shut</i>] Example: switch(config)# monitor session 3 rx switch(config-monitor)#	Enters the monitor configuration mode to configure a local SPAN/ERSPAN session. The optional keywords are as follows: <ul style="list-style-type: none"> • <i>rx</i>—Specifies an ingress extended SPAN session. • <i>tx</i>—Specifies an egress extended SPAN session. • <i>shut</i>—Specifies a shut state for the selected session.
Step 3	mode extended Example: switch(config-monitor)# mode extended	(Optional) Changes mode to extended mode for bidirectional sessions.
Step 4	filter frame-type source-ip src-ip Example: switch(config-monitor)# filter frame-type ipv4 src-ip 10.1.1.3/32 cos 3	Associates the rule-based filters to the session.
Step 5	Required: source interface ethernet x/y Example: switch(conf-monitor)# source interface Ethernet 4/7 switch(conf-monitor)# destination interface Ethernet 4/7	Associates the source port and the destination port.
Step 6	Required: no shut Example: switch(config-monitor)# no shut	Brings up the session. Note Filter command can be split into separate lines and configured under the session mode. All the filters specified

	Command or Action	Purpose
		under a session will be under the AND rule.

15.7.11 Configuring the Multicast Best Effort Mode for a SPAN Session

You can configure the multicast best effort mode for any SPAN session. By default, SPAN replication occurs on both the ingress and egress modules. When you enable the multicast best effort mode, SPAN replication occurs only on the ingress module for multicast traffic or on the egress module for packets that egress out of Layer 3 interfaces (that is, on the egress module, packets that egress out of Layer 2 interfaces are not replicated for SPAN).

Before you begin

Ensure that you are in the correct VDC (or use the `switchto vdc` command).

Procedure

	Command or Action	Purpose
Step 1	configure terminal Example: switch# configure terminal switch(config)#	Enters global configuration mode.
Step 2	monitor session <i>session-number</i> Example: switch(config)# monitor session 3 switch(config-monitor)#	Enters the monitor configuration mode and specifies the SPAN session for which the source rate limit is to be configured.
Step 3	Required: [no] multicast best-effort Example: switch(config-monitor)# multicast best-effort	Configures the multicast best effort mode for the specified SPAN session.
Step 4	show monitor session <i>session-number</i> Example: switch(config)# monitor session 3 switch(config-monitor)#	(Optional) Displays the status of SPAN sessions, including the configuration status of the rate limit, the percentage of the maximum SPAN rate allowed per session, and the modules on which the rate limit is and is not supported.
Step 5	(Optional) copy running-config startup-config Example: switch(config)# copy running-config startup-config	Copies the running configuration to the startup configuration.

15.7.12 Configuring Rule-Based SPAN

You can configure filters for ingress or egress SPAN traffic based on a set of rules. A simple filter has only one rule, and multiple fields or conditions can be added to this rule. The packets are spanned only if all conditions are met.

Before you begin

Ensure that you are in the correct VDC (or use the `switchto vdc` command).

Procedure

	Command or Action	Purpose
Step 1	configure terminal	Enters global configuration mode.

	Command or Action	Purpose
	Example: switch# configure terminal switch(config)#	
Step 2	monitor session <i>session-number</i> [shut] Example: switch(config)# monitor session 3 switch(config-monitor)#	Enters the monitor configuration mode. The new session configuration is added to the existing session configuration. By default, the session is created in the shut state, and the session is a local SPAN session. The optional keywords are as follows: <ul style="list-style-type: none"> rx—Specifies an ingress extended SPAN session. tx—Specifies an egress extended SPAN session. shut—Specifies a shut state for the selected session.
Step 3	mode extended Example: switch(config-monitor)# mode extended	(Optional) Configures the SPAN session as an extended bidirectional session.
Step 4	[no] filter [<i>vlan-range</i>] [bpdu [true false]] [cos <i>cos-value</i>] [dest-mac <i>dest-mac</i>] [eth-type <i>eth-value</i>] [flow-hash <i>flow-value</i>] [frame-type [eth arp fcoe ipv4 ipv6]] [pc-lane <i>port-number</i>] [src_mac <i>mac-address</i>] [trace-route [true false]] Example: switch(config-monitor)# filter vlan 10,20 switch(config-monitor)# filter frame-type arp trace-route true switch(config-monitor)# filter bpdu false	Configures the filter for the SPAN session. To remove the filter from the session, enter the no form of the command. The optional keywords are as follows: <ul style="list-style-type: none"> vlan—Specifies a filter based on a VLAN range. bpdu—Specifies a filter based on the bridge protocol data unit (BPDU) class of packets. cos—Specifies a filter based on the class of service (CoS) in the dot1q header. dest-mac—Specifies a filter based on a destination MAC address. eth-type—Specifies a filter based on the Ethernet type. flow-hash—Specifies a filter based on the result bundle hash (RBH) value. frame-type—Specifies a filter based on a frame type. pc-lane—Specifies a filter based on a member of the port channel. src-mac—Specifies a filter based on a source MAC address. trace-route—Specifies a filter based on the route bit in the header.
Step 5	(Optional) [no] filter frame-type eth Example: switch(config-monitor)# filter frame-type eth	(Optional) Configures the Ethernet frame type filter for the SPAN session. To remove the filter from the session, enter the no form of the command.
Step 6	(Optional) [no] filter frame-type arp [[arp-rarp [arp rarp]] [req-resp [req rsp]] [sender-ip <i>ip-address</i>] [target-ip <i>ip-address</i>]] Example:	(Optional) Configures the ARP frame type filter for the SPAN session. To remove the filter from the session, enter the no form of the command. The optional keywords are as follows:

	Command or Action	Purpose
	switch(config-monitor)# filter frame-type arp arp-rarp arp	<ul style="list-style-type: none"> • arp-rarp—Specifies an ARP or RARP frame type filter. • req-resp—Specifies a filter based on a request or response. • sender-ip—Specifies a filter based on a sender IP address. • target-ip—Specifies a filter based on a target IP address.
Step 7	(Optional) [no]filter frame-type fcoe fcoe [[fc-sid FC-source-ID] [fc-did FC-dest-ID] [fcoe-type fcoe-value] [r-ctl r-ctl-value] [sof sof-value] [cmd-code cmd-value]] Example: switch(config-monitor)# filter frame-type fcoe	(Optional) Configures the FCoE frame type filter for the SPAN session. To remove the filter from the session, enter the no form of the command. The optional keywords are as follows: <ul style="list-style-type: none"> • fc-sid—Specifies a filter based on an FC source ID. • fc-did—Specifies a filter based on an FC destination ID. • fcoe-type—Specifies a filter based on an FCoE type. • r-ctl—Specifies a filter based on the routing control flags (R CTL) value. • sof—Specifies a filter based on the start of frame (SOF) packets. • cmd-code—Specifies a filter based on a command code.
Step 8	(Optional) [no]filter frame-type ipv4 [[src-ip src-ip] [dest-ip dest-ip] [tos tos-value] [l4-protocol l4-value]] Example: switch(config-monitor)# filter frame-type ipv4 l4-protocol 3	(Optional) Configures the IPv4 frame type filter for the SPAN session. To remove the filter from the session, enter the no form of the command. The optional keywords are as follows: <ul style="list-style-type: none"> • src-ip—Specifies a filter based on an IPv4 source IP address. • dest-ip—Specifies a filter based on an IPv4 destination IP address. • tos—Specifies a filter based on the type of service (TOS) in the IP header. • l4-protocol—Specifies a filter based on a Layer 4 protocol number set in the protocol field of the IP header.
Step 9	(Optional) [no]filter frame-type ipv6 [[src-ip src-ip] [dest-ip dest-ip] [tos tos-value] [l4-protocol l4-value]] Example: switch(config-monitor)# filter frame-type ipv6 src-ip 10.0.0.1	(Optional) Configures the IPv6 frame type filter for the SPAN session. To remove the filter from the session, enter the no form of the command. The optional keywords are as follows: <ul style="list-style-type: none"> • src-ip—Specifies a filter based on an IPv6 source IP address. • dest-ip—Specifies a filter based on an IPv4 destination IP address. • tos—Specifies a filter based on the type of service (TOS) in the IP header. • l4-protocol—Specifies a filter based on a Layer 4 protocol number set in the protocol

	Command or Action	Purpose
		field of the IP header.
Step 10	(Optional) Repeat Steps 4 to 9 for all filters for the session.	
Step 11	source { interface <i>type</i> vlan { <i>number</i> <i>range</i> }} [rx tx both] Example: switch# configure terminal switch(config)#	(Optional) Configures sources and the traffic direction in which to copy packets. You can enter a range of Ethernet ports, a port channel, an inband interface, a range of VLANs, a Inspur CN 3000 Series Fabric Extender interface, or a fabric port channel connected to a Inspur CN 3000 Series Fabric Extender can configure one or more sources, as either a series of comma-separated entries or a range of numbers. You can specify up to 128 interfaces. The VLAN range is from 1 to 3967. The VLAN range of 4048 to 4093 is also supported for Inspur INOS releases prior to 6.1. You can specify the traffic direction to copy as ingress (rx), egress (tx), or both. By default, the direction is both. For a unidirectional session, the direction of the source must match the direction specified in the session.
Step 12	destination interface <i>type</i> { <i>number</i> <i>range</i> } Example: switch(config-monitor)# destination interface ethernet 2/5, ethernet 3/7	Configures destinations for copied source packets. You can configure one or more destinations as either a series of comma-separated entries or a range of numbers. You can specify up to 128 interfaces. Note SPAN destination ports must be either access or trunk ports. Note The Inspur CN 3000 Series Fabric Extender interfaces and the fabric port channels connected to the FEX cannot be configured as SPAN destinations.
Step 13	no shut Example: switch(config-monitor)# no shut	Enables the SPAN session. By default, the session is created in the shut state.
Step 14	(Optional) show monitor session { all <i>session-number</i> range <i>session-range</i> } [brief] Example: switch(config-monitor)# show monitor session 3	Displays the SPAN configuration.
Step 15	(Optional) copy running-config startup-config Example: switch(config)# copy running-config startup-config	Copies the running configuration to the startup configuration.

15.7.13 Configuring Exception SPAN

You can configure the device to span exception packets.

Before you begin

Ensure that you are in the correct VDC (or use the `switchto vdc` command).

Procedure

	Command or Action	Purpose
Step 1	configure terminal Example: switch# configure terminal switch(config)#	Enters global configuration mode.
Step 2	monitor session <i>session-number</i> [rx tx both] Example: switch(config)# monitor session 3 switch(config-monitor)#	Enters the monitor configuration mode and specifies the SPAN session. The optional keywords are as follows: <ul style="list-style-type: none"> • rx—Specifies an ingress extended SPAN session. • tx—Specifies an egress extended SPAN session. • shut—Specifies a shut state for the selected session.
Step 3	(Optional) mode extended Example: switch(config-monitor)# mode extended	(Optional) Configures the SPAN session as an extended bidirectional session form of the command.
Step 4	(Optional) [source exception {layer3 fabricpath other all}] Example: switch(config-monitor)# filter frame-type eth	Configures the source as an exception SPAN session. These exception types are supported: <ul style="list-style-type: none"> • layer3—Specifies the Layer 3 exception type. • fabricpath—Specifies the FabricPath exception type. • other—Specifies other exceptions that are dropped through redirect registers programmed with a drop destination interface. • all—Includes all Layer 3, FabricPath, and other exceptions.
Step 5	destination interface <i>type</i> [<i>number</i> <i>range</i>] Example: switch(config-monitor)# destination interface ethernet 2/5, ethernet 3/7	Configures destinations for copied source packets. You can configure one or more destinations as either a series of comma-separated entries or a range of numbers. You can specify up to 128 interfaces. Note SPAN destination ports must be either access or trunk ports. Note The Inspur CN3000 Series Fabric Extender interfaces and the fabric port channels connected to the FEX cannot be configured as SPAN destinations.
Step 6	no shut Example: switch(config)# no shut	Enables the SPAN session. By default, the session is created in the shut state.
Step 7	show monitor session <i>session-number</i> Example:	(Optional) Displays the status of SPAN sessions, including the configuration status of the rate

	switch(config)# show monitor session 3	limit, the percentage of the maximum SPAN rate allowed per session, and the modules on which the rate limit is and is not supported.
Step 8	(Optional) copy running-config startup-config Example: switch(config)# copy running-config startup-config	Copies the running configuration to the startup configuration.

15.7.14 Removing FabricPath and VNTAG Headers

If you are working with a device connected to a SPAN destination port that does not understand FabricPath or VNTAG headers, you may want those headers stripped from the packet.

You can do this at either the global or port level. If you want to strip the headers to all SPAN destination ports in the VDC, you can apply the global command. If you want to apply the command only to a certain port, you can use the port-level command. If the ports are not SPAN destination ports, the command is rejected.

When you enter both the global and port-level configurations for this feature, the port-level overrides the global configuration.

15.7.14.1 Removing Headers Globally

Before you begin

Ensure that you are in the correct VDC (or use the switchto vdc command).

Procedure

	Command or Action	Purpose
Step 1	switch# configure terminal	Enters global configuration mode.
Step 2	switch(config)# system default switchport monitor exclude header	Removes the FabricPath and VNTAG headers for all SPAN destination ports in the VDC. Use the no form of the command to preserve the headers on packets for SPAN destination ports.
Step 3	(Optional) switch(config)# copy running-config startup-config	Copies the running configuration to the startup configuration.

15.7.14.2 Removing Headers per Port

Before you begin

Ensure that you are in the correct VDC (or use the switchto vdc command).

Procedure

	Command or Action	Purpose
Step 1	switch# configure terminal	Enters global configuration mode.
Step 2	switch(config)# interface type {module port}	Enters the interface mode and specifies the port or ports from which you want to remove the FabricPath and VNTAG headers.
Step 3	(Optional) switch(config)# [no]switchport monitor exclude header	Removes the FabricPath and VNTAG headers for the specified SPAN destination ports in the VDC. Use the no form of the command to preserve the headers on packets for SPAN destination ports.

Step 4	(Optional) <code>switch(config)# exit</code>	Returns to global configuration mode.
Step 5	(Optional) <code>switch# copy running-config startup-config</code>	Copies the running configuration to the startup configuration.

15.8 Verifying the SPAN Configuration

To display the SPAN configuration, perform one of the following tasks:

Command	Purpose
<code>show monitor session {all session-number range session-range} [brief]</code>	Displays the SPAN session configuration.
<code>show resource monitor-session</code>	Displays the resources that are available for the traditional sessions.
<code>show resource monitor-session-extended</code>	Displays the resources that are available for the extended session.
<code>show running-config</code>	Displays configuration of the commands for removing the FabricPath and VNTAG headers for SPAN.

15.9 Configuration Examples for SPAN

15.9.1 Configuration Example for a SPAN Session

To configure a SPAN session, follow these steps:

Procedure

Step 1 Configure destination ports in access mode and enable SPAN monitoring.

Example:

```
switch# configure terminal
switch(config)# interface ethernet 2/5
switch(config-if)# switchport
switch(config-if)# switchport monitor
switch(config-if)# no shut
switch(config-if)# exit
switch(config)#
```

Step 2 Configure a SPAN session.

Example:

```
switch(config)# no monitor session 3
switch(config)# monitor session 3
switch(config-monitor)# source interface ethernet 2/1-3, ethernet 3/1 rx
switch(config-monitor)# source interface port-channel 2
switch(config-monitor)# source interface sup-eth 0 both
switch(config-monitor)# source vlan 3, 6-8 rx
switch(config-monitor)# source interface ethernet 101/1/1-3
switch(config-monitor)# filter vlan 3-5, 7
switch(config-monitor)# destination interface ethernet 2/5
switch(config-monitor)# no shut

switch(config-monitor)# exit
switch(config)# show monitor session 3
switch(config)# copy running-config startup-config
```

15.9.2 Configuration Example to Monitor All VLANs and Ports in an Extended SPAN Monitor Session

Example

This example shows how to monitor all VLANs and ports in an Extended SPAN monitor session:

```
switch# configure terminal
switch(config)# monitor session 3
switch(config-monitor)# mode extended
switch(config-monitor)# source interface all
switch(config-monitor)# destination interface ethernet 2/5
switch(config-monitor)# no shut
switch(config-monitor)# exit
switch(config)# show monitor session 3
switch(config)# copy running-config startup-config
```

This example shows how to monitor a higher number of specific VLAN sources than the VLAN source limits currently supported in the extended SPAN monitor session:

```
switch# configure terminal
switch(config)# monitor session 2
switch(config-monitor)# mode extended
switch(config-monitor)# source interface all
switch(config-monitor)# filter vlan 1-1000
switch(config-monitor)# destination interface ethernet 4/1
switch(config-monitor)# no shut
switch(config-monitor)# exit
switch(config)# show monitor session 2
switch(config)# copy running-config startup-config
```

15.9.3 Configuration Example for a Unidirectional SPAN Session

To configure a unidirectional SPAN session, follow these steps:

Procedure

-
- Step 1** Configure destination ports in access mode and enable SPAN monitoring.

Example:

```
switch# configure terminal
switch(config)# interface ethernet 2/5
switch(config-if)# switchport
switch(config-if)# switchport monitor
switch(config-if)# no shut
switch(config-if)# exit
switch(config)#
```

- Step 2** Configure a SPAN session.

Example:

```
switch(config)# no monitor session 3
switch(config)# monitor session 3 rx
switch(config-monitor)# source interface ethernet 2/1-3, ethernet 3/1 rx
switch(config-monitor)# filter vlan 3-5, 7
switch(config-monitor)# destination interface ethernet 2/5
switch(config-monitor)# no shut
switch(config-monitor)# exit
```



```
switch(config)# show monitor session 3
switch(config)# copy running-config startup-config
```

15.9.4 Configuration Example for a Virtual SPAN Session

Procedure

- Step 1** Configure destination ports in access or trunk mode, and enable SPAN monitoring.

Example:

```
switch# configure terminal
switch(config)# interface ethernet 3/1
switch(config-if)# switchport
switch(config-if)# switchport mode trunk
switch(config-if)# switchport trunk allowed vlan add 100-200
switch(config-if)# switchport monitor
switch(config-if)# no shut
switch(config-if)# exit
switch(config)# interface ethernet 3/2
switch(config-if)# switchport
switch(config-if)# switchport mode trunk
switch(config-if)# switchport trunk allowed vlan add 201-300
switch(config-if)# switchport monitor
switch(config-if)# no shut
switch(config-if)# exit
switch(config)#
```

- Step 2** Configure a SPAN session.

Example:

```
switch(config)# no monitor session 4
switch(config)# monitor session 4tx
switch(config-monitor)# source vlan 100-300
switch(config-monitor)# destination interface ethernet 3/1-2
switch(config-monitor)# no shut
switch(config-monitor)# exit
switch(config)# show monitor session 4
switch(config)# copy running-config startup-config
```

15.9.5 Configuration Example for a SPAN Session with a Private VLAN Source

To configure a SPAN session that includes a private VLAN source, follow these steps:

Procedure

- Step 1** Configure source VLANs.

Example:

```
switch# configure terminal
switch(config)# vlan 100
switch(config-vlan)# private-vlan primary
switch(config-vlan)# exit
switch(config)# interface ethernet 3/1
switch(config-if)# switchport
switch(config-if)# switchport access vlan 100
switch(config-if)# no shut
```

```

switch(config-if)# exit
switch(config)# interface ethernet 3/2
switch(config-if)# switchport
switch(config-if)# switchport mode trunk
switch(config-if)# switchport trunk native vlan 100
switch(config-if)# no shut
switch(config-if)# exit
switch(config)#

```

Step 2 Configure destination ports in access or trunk mode, and enable SPAN monitoring.

Example:

```

switch# configure terminal
switch(config)# interface ethernet 3/3
switch(config-if)# switchport
switch(config-if)# switchport mode trunk
switch(config-if)# switchport trunk allowed vlan add 100-200
switch(config-if)# switchport monitor
switch(config-if)# switchport access vlan 100
switch(config-if)# no shut
switch(config-if)# exit
switch(config)#

```

Step 3 Configure a SPAN session.

Example:

```

switch# no monitor session 3
switch(config)# monitor session 3
switch(config-if)# source vlan 100
switch(config-if)# destination interface ethernet 3/3
switch(config-if)# no shut
switch(config-if)# exit
switch(config-if)# show monitor session 3
switch(config-if)# copy running-config startup-config

```

15.9.6 Configuration Example for SPAN with MTU Truncation and SPAN Sampling

Example

This example shows how to configure MTU truncation and SPAN sampling for a SPAN session:

```

switch# configure terminal
switch(config)# monitor session 3
switch(config-monitor)# mtu 100
switch(config-monitor)# sampling 10
switch(config-monitor)# show monitor session 3

```

15.9.7 Configuration Example for Rule-Based SPAN

Example

This example shows how to configure a rule-based SPAN session:

```

switch# configure terminal
switch(config)# monitor session 3
switch(config-monitor)# mode extended
switch(config-monitor)# filter frame-type ipv4 src-ip 10.1.1.1/24
switch(config-monitor)# source interface ethernet 2/1-3, ethernet 3/1 rx
switch(config-monitor)# destination interface ethernet 2/5, ethernet 3/7
switch(config-monitor)# no shut
switch(config)# show monitor session 3

```

15.9.8 Configuration Example for Exception SPAN

Example

This example shows how to configure a SPAN session to span exception packets:

```
switch# configure terminal
switch(config)# monitor session 3
switch(config-monitor)# source exception all
switch(config-monitor)# destination interface ethernet 2/5, ethernet 3/7
switch(config-monitor)# no shut
switch(config)# show monitor session 3
```

15.10 Related Documents

Table 29 Related Documents

Related Topic	Document Title
Inspur Network Analysis Module (NAM)	<i>Inspur Network Analysis Module (NAM) for CN12700 Quick Start Guide</i>
VDCs	<i>Inspur CN12700 Series INOS Virtual Device Context Configuration Guide</i>
Fabric Extender	<i>Inspur CN3000 Series Fabric Extender Software Configuration Guide</i>
SPAN commands: complete command syntax, command modes, command history, defaults, usage guidelines, and examples	<i>Inspur CN12700 Series INOS System Management Command Reference</i>

15.11 Feature History for SPAN

The table below summarizes the new and changed features for this document and shows the releases in which each feature is supported. Your software release might not support all the features in this document. For the latest caveats and feature information, the release notes for your software release.

Table 30 Feature History for SPAN

Feature Name	Releases	Feature Information
SPAN	7.3(0)DX(1)	Added support for M3 Series modules.
SPAN	7.3(0)D1(1)	Added support for 4K VLANs per SPAN Session.
SPAN	6.2(10)	Added support to remove FabricPath and VLAN tag headers from SPAN packets.
SPAN	6.2(2)	Added NAM support for SPAN data sources.
SPAN	6.2(2)	Added support for FEX ports as a SPAN source in the Tx direction only on F2e Series modules
SPAN	6.2(2)	Added support for extended SPAN.
SPAN	6.2(2)	Added support for rule-based SPAN.
SPAN	6.2(2)	Added support for exception SPAN.
SPAN	6.1(1)	Added support for SPAN sampling.
SPAN	6.1(1)	Allowed the inband interface to be added as a source from any VDC except the admin VDC.
SPAN	6.1(1)	Added support for Supervisor 2.
SPAN	6.1(1)	Added support for M2 Series modules.
SPAN	6.1(1)	Added FCoE SPAN support on F2 Series modules for storage VDCs.
SPAN	6.0(1)	Added support for F2 Series modules.

SPAN	5.2(1)	Added SPAN source support for Inspur CN3000 Series Fabric Extender interfaces.
SPAN	5.2(1)	Added the ability to configure MTU truncation, the source rate limit, and the multicast best effort mode for each SPAN session.
SPAN	5.1(1)	Added support for F1 Series modules and increased the number of supported SPAN sessions from 18 to 48.
SPAN	4.1(3)	Added a table of SPAN session limits.

CHAPTER 16 Configuring ERSPAN

This chapter describes how to configure an encapsulated remote switched port analyzer (ERSPAN) to transport mirrored traffic in an IP network on Inspur INOS devices.

This chapter contains the following sections:

- Finding Feature Information
- About ERSPAN
- Licensing Requirements for ERSPAN
- Prerequisites for ERSPAN
- Guidelines and Limitations for ERSPAN
- Default Settings
- Configuring ERSPAN
- Verifying the ERSPAN Configuration
- Configuration Examples for ERSPAN
- Related Documents
- Feature History for ERSPAN

16.1 Finding Feature Information

Your software release might not support all the features documented in this module. For the latest caveats and feature information, the release notes for your software release. To find information about the features documented in this module, and to see a list of the releases in which each feature is supported, see the "New and Changed Information" chapter or the Feature History table in this chapter.

16.2 About ERSPAN

ERSPAN transports mirrored traffic over an IP network, which provides remote monitoring of multiple switches across your network. The traffic is encapsulated at the source router and is transferred across the network. The packet is decapsulated at the destination router and then sent to the destination interface.

16.2.1 ERSPAN Types

Inspur INOS Release 6.1 and later releases support ERSPAN Type II and Type III. All previous Inspur INOS releases support only ERSPAN Type II.

ERSPAN Type III supports all of the ERSPAN Type II features and functionality and adds these enhancements:

- Provides timestamp information in the ERSPAN Type III header that can be used to calculate packet latency among edge, aggregate, and core switches.
- Identifies possible traffic sources using the ERSPAN Type III header fields.
- Provides the ability to configure timestamp granularity across all VDCs to determine how the clock manager synchronizes the ERSPAN timers.

16.2.2 ERSPAN Sources

The interfaces from which traffic can be monitored are called ERSPAN sources. Sources designate the traffic to monitor and whether to copy ingress, egress, or both directions of traffic. ERSPAN sources include the following:

- Ethernet ports and port channels.
- The inband interface to the control plane CPU—You can monitor the inband interface only from the default virtual device context (VDC). Inband traffic from all VDCs is monitored.

- VLANs (ingress only)—When a VLAN is specified as an ERSPAN source, all supported interfaces in the VLAN are ERSPAN sources.

- Fabric port channels connected to the Inspur CN3000 Series Fabric Extender (FEX).

- Satellite ports and host interface port channels on the Inspur CN3000 Series Fabric Extender— These interfaces are supported in Layer 2 access mode, Layer 2 trunk mode, and Layer 3 mode.

See the Inspur CN12700 Series INOS Verified Scalability Guide for information on the number of supported ERSPAN sessions.

ERSPAN source ports have the following characteristics:

- A port configured as a source port cannot also be configured as a destination port.

- ERSPAN does not monitor any packets that are generated by Supervisor 1, regardless of their source. This limitation does not apply to Supervisor 2.

16.2.3 ERSPAN Destinations

Destination ports receive the copied traffic from ERSPAN sources. ERSPAN destination ports have the following characteristics:

- Destinations for an ERSPAN session include Ethernet ports or port-channel interfaces in either access or trunk mode.

- A port configured as a destination port cannot also be configured as a source port.

- A destination port can be configured in only one ERSPAN session at a time.

- Destination ports do not participate in any spanning tree instance or any Layer 3 protocols.

- Ingress and ingress learning options are not supported on monitor destination ports.

- F Series module core ports, Fabric Extender host interface (HIF) ports, HIF port channels, and fabric port-channel ports are not supported as ERSPAN destination ports.

16.2.4 ERSPAN Sessions

You can create ERSPAN sessions that designate sources and destinations to monitor. The figure below shows an ERSPAN configuration.

Figure 6 ERSPAN Configuration

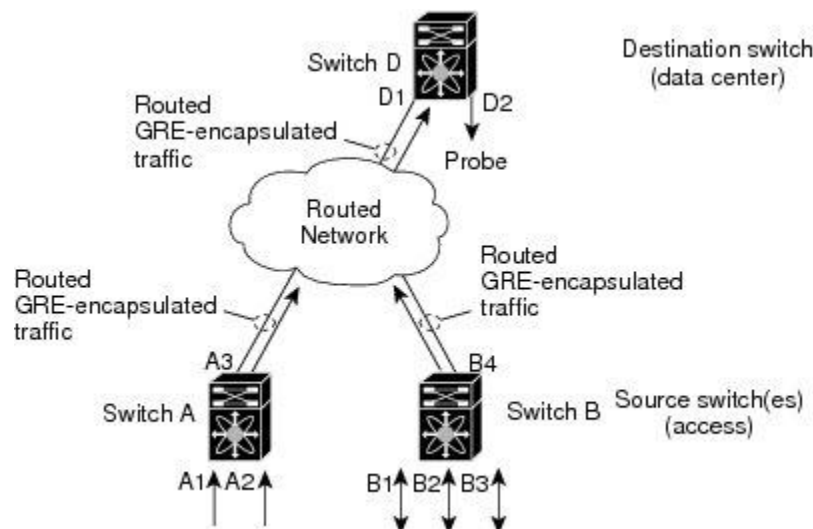

16.2.5 Extended ERSPAN Session

Inspur INOS Release 6.2(2) and later releases support extended ERSPAN sessions in addition to the two traditional ERSPAN sessions in prior releases. Extended ERSPAN sessions can be bidirectional or unidirectional. The session direction is specified during session creation. A pool of 12 independent session resources are available. Unidirectional sessions use one resource, and bidirectional use two resources. These 12 resources are shared between local and ERSPAN source sessions across all VDCs.

If you are configuring an extended SPAN session on a Inspur CN 12700, the following applies:

- You can configure 16 sessions as unidirectional or bidirectional, as required.
- You do not need to maintain two traditional sessions.
- You do not need to use the resource manager to reserve the two traditional sessions.
- ERSPAN ACL-based filtering is not supported.

16.2.6 4K VLANs per ERSPAN Session

Inspur INOS Release 7.3(0)D1(1) and later releases support 4K VLANs per ERSPAN session. You can use the source interface all command to enable the monitor session on the switch to monitor all VLANs and ports in the VDC such as physical ports, Port Channels, FEX ports and FEX Port Channels. The 4K VLANs per ERSPAN Session feature also enables monitoring of a higher number of specific VLAN sources than the VLAN source limits currently supported in the monitor session by using the filter vlan command with the source interface all command to filter the irrelevant VLANs.

The 4K VLANs per ERSPAN Session feature has the following characteristics:

- You can use the source interface all command for multiple sessions in the same VDC.
- Supports all session parameters such as MTU truncation, Sampling and Rate Limiting.
- Simple and Complex Rule-based SPAN is supported with the source interface all command. This enables traffic flow-based monitoring using a set of filter rules across the VDC.
- Traffic generated by Supervisors is not spanned.
- Supported only in Ethernet VDCs of Inspur CN12700 Series switches.
- Supported only in extended SPAN sessions.

16.2.7 Rule-Based ERSPAN

Rule-based ERSPAN filters the ingress or egress ERSPAN traffic based on a set of rules. For Inspur INOS releases prior to 6.2(2), you can filter on VLANs, the destination index, and the source index. Beginning with Inspur INOS Release 6.2(2), you can filter the ERSPAN traffic based on a combination of fields in the Layer 2, Layer 3, or Layer 4 header packet.

Every ERSPAN session (traditional and extended) has an associated filter. Every ERSPAN session has one filter resource. A simple filter has only one rule, and you can add multiple fields or conditions to this rule. The packets are spanned only if all conditions are met.

Ethernet	IPv4	IPv6	ARP/RARP	FCoE
Frame Type	Frame Type	Frame Type	Frame Type	Frame Type
VLAN	VLAN	VLAN	VLAN	VLAN
TR	TR	TR	TR	TR
BPDU	BPDU	BPDU	BPDU	BPDU
Port Channel	Port Channel	Port Channel	Port Channel	Port Channel
Lane	Lane	Lane	Lane	Lane
Flow Hash	Flow Hash	Flow Hash	Flow Hash	Flow Hash
L2 MAC DA	L2 MAC DA	L2 MAC DA	L2 MAC DA	L2 MAC DA

Ethernet	IPv4	IPv6	ARP/RARP	FCoE
L2 MAC SA EtherType CoS/VL	L2 MAC SA EtherType CoS/VL ToS L4 Protocol IPv4 SA IPv4 DA	L2 MAC SA EtherType CoS/VL ToS L4 Protocol IPv6 SA IPv6 DA	L2 MAC SA EtherType CoS/VL ARP Request Sender IP Target IP	L2 MAC SA EtherType CoS/VL FCD_ID FCS_ID SOF R_CTL TYPE Cmd_Code Sec_Hdr Exists

16.2.8 Exception ERSPAN

Exception ERSPAN enables you to span exception packets. Packets that have failed an intrusion detection system (IDS), Layer 3 IP verification, and FabricPath are treated as exception packets.

The exception ERSPAN session is supported in either one of the two traditional ERSPAN sessions or in one of the extended ERSPAN sessions. Rate limiters, MTU truncation, and sampling are supported in the exception ERSPAN session. Only the exception packets sent to the drop destination interface are supported as an ERSPAN source. Exception packets that are pushed to the supervisor, the ACLQoS, or Layer 2 are not spanned. Each VDC supports one exception ERSPAN session.

Exception ERSPAN is supported in the egress direction only. In the case of an extended ERSPAN Rx session, the exception source configuration will be rejected.

16.2.9 Network Analysis Module

You can also use the Inspur Network Analysis Module (NAM) to monitor ERSPAN data sources for application performance, traffic analysis, and packet header analysis.

To use NAM for monitoring the Inspur CN12700 ERSPAN data sources, see the Inspur CN12700 Series Network Analysis Module (NAM-NX1) Quick Start Guide.

16.2.10 High Availability

The ERSPAN feature supports stateless and stateful restarts. After a reboot or supervisor switchover, the running configuration is applied.

For more information on high availability, see the *Inspur CN12700 Series INOS High Availability and Redundancy Guide*.

16.2.11 Virtualization Support

A virtual device context (VDC) is a logical representation of a set of system resources. ERSPAN applies only to the VDC where the commands are entered.

For information about configuring VDCs, see the *Inspur CN12700 Series INOS Virtual Device Context Configuration Guide*.

16.3 Licensing Requirements for ERSPAN

The following table shows the licensing requirements for this feature:

Product	License Requirement
Inspur INOS	ERSPAN requires no license. Any feature not included in a license package is bundled with the INOS image and is provided at no extra charge to you. For a complete explanation of the Inspur INOS licensing scheme, see the <i>Inspur INOS Licensing Guide</i> .

16.4 Prerequisites for ERSPAN

ERSPAN has the following prerequisites:

- You must first configure the ports on each device to support the desired ERSPAN configuration. For more information, see the *Inspur CN12700 Series INOS Interfaces Configuration Guide*.

16.5 Guidelines and Limitations for ERSPAN

ERSPAN has the following configuration guidelines and limitations:

- For ERSPAN session limits, see the *Inspur CN12700 Series INOS Verified Scalability Guide*.
- All ERSPAN replication is performed in the hardware. The supervisor CPU is not involved.
- Control plane traffic generated by Supervisor 2 can be ERSPAN encapsulated but cannot be filtered by an ERSPAN ACL.
- Control plane packets generated by Supervisor 1 cannot be ERSPAN encapsulated or filtered by an ERSPAN ACL.
- When you configure ERSPAN source on a Inspur CN12700 Series switch that acts as a MPLS PE and the destination of the ERSPAN session is remote across the MPLS network, the ERSPAN packet will be transmitted as a regular IP packet and does not include the MPLS label. It causes the packet being dropped at the remote PE.
- ERSPAN and ERSPAN ACLs are not supported on F1 Series modules. For the VDCs that have F1 Series modules only, you can configure ERSPAN source and destination sessions and ERSPAN ACL source sessions but never come up.
- ERSPAN source sessions are supported on F2 Series and F2e (enhanced) Series modules. Beginning with Inspur INOS Release 6.2(2), ERSPAN destination sessions are also supported on these modules. However, ERSPAN ACL sessions are not supported on F2 Series and F2e Series modules.
- ERSPAN source, destination, and ACL sessions are supported on M Series modules.
- The decapsulation of generic routing encapsulation (GRE) or ERSPAN packets received on an F1 Series module is not supported.
- ERSPAN and ERSPAN ACL sessions are terminated identically at the destination router.
- ERSPAN is not supported for management ports.
- ERSPAN does not support packet fragmentation. The "do not fragment" bit is set in the IP header of ERSPAN packets.
- A destination port can be configured in only one ERSPAN session at a time.
- You cannot configure a port as both a source and destination port.
- A single ERSPAN session can include mixed sources in any combination of the following:
 - Ethernet ports or port channels but not subinterfaces
 - VLANs (ingress only)
 - The inband interface or port channels to the control plane CPU
- Destination ports do not participate in any spanning tree instance or Layer 3 protocols.
- When an ERSPAN session contains source ports or VLAN sources that are monitored in the transmit or receive direction, packets that these ports receive might be replicated to the ERSPAN destination port even though the packets are not actually transmitted on the source ports. Some examples of this behavior on source ports are as follows:
 - Traffic that results from flooding
 - Broadcast and multicast traffic
 - You can enable ERSPAN for a source port before it becomes operationally active. For Layer 2 ports, traffic

flooded to the VLANs that contain these ports are captured even when the link is not connected for the ports.

- For VLAN ERSPAN sessions with both ingress and egress configured, two packets (one from ingress and one from egress) are forwarded from the destination port if the packets get switched on the same VLAN.
- You can monitor the inband interface only from the default VDC. Inband traffic from all VDCs is monitored.
- Beginning with Inspur INOS Release 5.2, you can configure the Inspur CN3000 Series Fabric Extender (FEX) interfaces and the fabric port channels connected to the Inspur CN3000 Series Fabric Extender as ERSPAN sources. However, you cannot configure them as ERSPAN destinations.
- For ERSPAN sessions, the recommended MTU size is 144 bytes or greater because MTU truncation occurs after the packets are encapsulated.
- The rate limit percentage of an ERSPAN session is based on 10G, 40G, and 100G for the respective modules (that is, 1 percent corresponds to 0.1G, 0.4G, or 1G respectively), and the value is applied per every forwarding engine instance.
- While setting IP TTL in the ERSPAN header,
- In M-series LC, after ERSPAN encapsulation / de-capsulation, the packets are sent to EARL for recirculating and hence, the TTL is decremented by EARL.
- Multicast best effort mode applies only to M1 Series modules.
- Beginning with Inspur INOS Release 6.1, ERSPAN source sessions are supported on Supervisor 2, but ERSPAN ACL sessions are not.
- Supervisor 2 supports ERSPAN Type II and ERSPAN Type III for inband ports, but timestamps are not synchronized with the Precision Time Protocol (PTP) master timers.
- 1588 granularity mode is not supported in Inspur INOS Release 6.1 and is rejected if selected.
- If you enable ERSPAN on a vPC and ERSPAN packets need to be routed to the destination through the vPC, packets that come through the vPC peer-link cannot be captured.
- ERSPAN ACLs are not supported for use with OTV.
- ERSPAN source sessions are supported on F3 Series modules. Beginning with Inspur INOS Release 7.2, ERSPAN destination sessions are also supported on these modules. However, ERSPAN ACL sessions are not supported on F3 Series modules.
- The ERSPAN termination takes place at the ingress point of entry of the destination switch (and not the final destination), so the ingress module at the destination switch must support ERSPAN termination. Beginning with Inspur INOS release 7.2(0)D1(1), ERSPAN Termination is supported on F3 linecards.

16.6 Default Settings

The following table lists the default settings for ERSPAN parameters.

Table 31 Default ERSPAN Parameters

Parameters	Default
ERSPAN sampling	Disabled
ERSPAN sessions	Created in the shut state
ERSPAN source rate limit for traditional ERSPAN sessions	Disabled
ERSPAN source rate limit for extended ERSPAN sessions	Enabled
Global granularity of ERSPAN Type III sessions	100 microseconds
MTU truncation	Disabled
Multicast best effort mode	Disabled

16.7 Configuring ERSPAN

16.7.1 Configuring an ERSPAN Source Session

You can configure an ERSPAN session on the local device only. By default, ERSPAN sessions are created in the shut state.

For sources, you can specify Ethernet ports, port channels, the supervisor inband interface, and VLANs (ingress only). A single ERSPAN session can include mixed sources in any combination of Ethernet ports, VLANs, or the inband interface to the control plane CPU.

For traditional sessions, you can configure the sessions without specifying the direction of the traffic.

Procedure

	Command or Action	Purpose
Step 1	switch# configure terminal	Enters global configuration mode.
Step 2	switch(config)# monitor erspan origin ip-address ip-address global	Configures the ERSPAN global origin IP address.
Step 3	switch(config)# no monitor session { <i>session-number</i> all }	Clears the configuration of the specified ERSPAN session. The new session configuration is added to the existing session configuration.
Step 4	switch(config)# monitor session { <i>session-number</i> all } type erspan-source [shut]	Configures an ERSPAN Type II source session. By default the session is bidirectional. The optional keyword shut specifies a shut state for the selected session.
Step 5	switch(config-erspan-src)# description <i>description</i>	Configures a description for the session. By default, no description is defined. The description can be up to 32 alphanumeric characters.
Step 6	switch(config-erspan-src)# source {[interface [all] [<i>type slot/port[-port]</i>], <i>type</i> <i>slot/port[-port]</i>]} [port-channel <i>channel-number</i>] [vlan { <i>number</i> <i>range</i> }] [rx tx both]	Configures the sources and traffic direction in which to copy packets. You can enter a range of Ethernet ports, a port channel, an inband interface, or a range of VLANs. You can configure one or more sources, as either a series of comma-separated entries or a range of numbers. You can specify the traffic direction to copy as ingress, egress, or both. The default direction is both. Note Source VLANs are supported only in the ingress (rx) direction. For a unidirectional session, the direction of the source must match the direction specified in the session. Beginning with Inspur INOS Release 7.3(0)D1(1), you can use the all keyword to enable the monitor session to monitor all VLANs and ports in the VDC such as physical ports, Port Channels, FEX ports and FEX Port Channels. The all keyword is supported only in extended ERSPAN sessions.
Step 7	(Optional) Repeat Step 6 to configure all ERSPAN sources.	—
Step 8	(Optional) switch(config-erspan-src)# filter vlan { <i>number</i> <i>range</i> }	Configures which VLANs to select from the configured sources. You can configure one or

	Command or Action	Purpose
		more VLANs, as either a series of comma-separated entries or a range of numbers. For information on the VLAN range, see the <i>Inspur CN12700 Series INOS Layer 2 Switching Configuration Guide</i> . You can enable monitoring of a higher number of specific VLAN sources than the VLAN source limits currently supported in extended ERSPAN monitor session by using the filter vlan command with the source interface all command to filter the irrelevant VLANs.
Step 9	(Optional) Repeat Step 8 to configure all source VLANs to filter.	—
Step 10	(Optional) switch(config-erspan-src)# filter access-group <i>acl-filter</i>	Associates an ACL with the ERSPAN session. Note You can create an ACL using the standard ACL configuration process. For more information, see the <i>Inspur CN12700 Series INOS Security Configuration Guide</i> .
Step 11	switch(config-erspan-src)# destination ip <i>ip-address</i>	Configures the destination IP address in the ERSPAN session. Only one destination IP address is supported per ERSPAN source session.
Step 12	switch(config-erspan-src)# erspan-id <i>erspan-id</i>	Configures the ERSPAN ID for the ERSPAN source session. The ERSPAN range is from 1 to 1023.
Step 13	switch(config-erspan-src)# vrf <i>vrf-name</i>	Configures the virtual routing and forwarding (VRF) instance that the ERSPAN source session uses for traffic forwarding. The VRF name can be any case-sensitive, alphanumeric string up to 32 characters.
Step 14	(Optional) switch(config-erspan-src)# ip ttl <i>ttl-number</i>	Configures the IP time-to-live (TTL) value for the ERSPAN traffic. The range is from 1 to 255.
Step 15	(Optional) switch(config-erspan-src)# ip dscp <i>dscp-number</i>	Configures the differentiated services code point (DSCP) value of the packets in the ERSPAN traffic. The range is from 0 to 63.
Step 16	switch(config-erspan-src)# no shut	Enables the ERSPAN source session. By default, the session is created in the shut state.
Step 17	switch(config-erspan-src)# exit	Exits the monitor configuration mode.
Step 18	(Optional) switch(config)# show monitor session { all <i>session-number</i> range <i>session-range</i> } [brief]	Displays the ERSPAN session configuration.
Step 19	(Optional) switch(config)# show running-config monitor	Displays the running ERSPAN configuration.
Step 20	(Optional) switch(config)# show startup-config monitor	Displays the ERSPAN startup configuration.
Step 21	(Optional) switch(config)# copy running-config startup-config	Copies the running configuration to the startup configuration.

16.7.2 Configuring an ERSPAN Destination Session

You can configure an ERSPAN destination session to copy packets from a source IP address to destination ports on the local device. By default, ERSPAN destination sessions are created in the shut state.

Before you begin

Ensure that you are in the correct VDC (or use the `switchto vdc` command).

Ensure that you have already configured the destination ports in monitor mode. For more information, see the *Inspur CN12700 Series INOS Interfaces Configuration Guide*.

Procedure

	Command or Action	Purpose
Step 1	switch# configure terminal	Enters global configuration mode.
Step 2	switch(config)# interface ethernet <i>slot/port[-port]</i>	Enters interface configuration mode on the selected slot and port or range of ports.
Step 3	switch(config-if)# switchport	Configures switchport parameters for the selected slot and port or range of ports.
Step 4	switch(config-if)# switchport mode [access trunk]	Configures the following switchport modes for the selected slot and port or range of ports: <ul style="list-style-type: none"> • access • trunk
Step 5	switch(config-if)# switchport monitor	Configures the switchport interface as an ERSPAN destination.
Step 6	(Optional) Repeat Steps 2 to 5 to configure monitoring on additional ERSPAN destinations.	—
Step 7	switch(config-if)# no monitor session { <i>session-number</i> all }	Clears the configuration of the specified ERSPAN session. The new session configuration is added to the existing session configuration.
Step 8	switch(config-if)# monitor session { <i>session-number</i> all } type erspan-destination	Configures an ERSPAN destination session.
Step 9	switch(config-erspan-dst)# description <i>description</i>	Configures a description for the session. By default, no description is defined. The description can be up to 32 alphanumeric characters.
Step 10	switch(config-erspan-dst)# source ip <i>ip-address</i>	Configures the source IP address in the ERSPAN session. Only one source IP address is supported per ERSPAN destination session. Note The source IP address must be the IP address on the local device that is configured as the destination IP address on the ERSPAN source. This is the interface on the local device where the Inspur CN12700 device expects to receive packets for decapsulation.
Step 11	switch(config-erspan-dst)# destination { [interface [<i>type slot/port[-port]</i>], <i>type slot/port[-port]</i>] [port-channel <i>channel-</i>	Configures a destination for copied source packets. You can configure one or more interfaces as a series of comma-separated

	Command or Action	Purpose
	<code>number]]}</code>	entries. Note You can configure destination ports as trunk ports. For more information, see the <i>Inspur CN12700 Series INOS Interfaces Configuration Guide</i> .
Step 12	(Optional) Repeat Step 11 to configure all ERSPAN destination ports.	—
Step 13	<code>switch(config-erspan-dst)# erspan-id erspan-id</code>	Configures the ERSPAN ID for the ERSPAN session. The range is from 1 to 1023.
Step 14	<code>switch(config-erspan-dst)# vrf vrf-name</code>	Configures the VRF that the ERSPAN destination session uses for traffic forwarding.
Step 15	<code>switch(config-erspan-dst)# no shut</code>	Enables the ERSPAN destination session. By default, the session is created in the shut state.
Step 16	<code>switch(config-erspan-dst)# exit</code>	Exits monitor configuration mode.
Step 17	<code>switch(config)# exit</code>	Exits global configuration mode.
Step 18	(Optional) <code>switch# show monitor session {all session-number range session-range} [brief]</code>	Displays the ERSPAN session configuration.
Step 19	(Optional) <code>switch# show running-config monitor</code>	Displays the running ERSPAN configuration.
Step 20	(Optional) <code>switch# show startup-config monitor</code>	Displays the ERSPAN startup configuration.
Step 21	(Optional) <code>switch# copy running-config startup-config [vdc-all]</code>	Copies the running configuration to the startup configuration.

16.7.3 Shutting Down or Activating an ERSPAN Session

You can shut down ERSPAN sessions to discontinue the copying of packets from sources to destinations. You can shut down one session in order to free hardware resources to enable another session. By default, ERSPAN sessions are created in the shut state.

You can enable ERSPAN sessions to activate the copying of packets from sources to destinations. To enable an ERSPAN session that is already enabled but operationally down, you must first shut it down and then enable it. You can shut down and enable the ERSPAN session states with either a global or monitor configuration mode command.

Procedure

	Command or Action	Purpose
Step 1	<code>switch# configure terminal</code>	Enters global configuration mode.
Step 2	<code>switch(config)# monitor session {session-range all} shut</code>	Shuts down the specified ERSPAN sessions. By default, sessions are created in the shut state.
Step 3	<code>switch(config)# no monitor session {session-range all} shut</code>	Resumes (enables) the specified ERSPAN sessions. By default, sessions are created in the shut state. If a monitor session is enabled but its operational status is down, then to enable the session, you must first specify the monitor session shut command followed by the no monitor session shut command.
Step 4	<code>switch(config)# monitor session session-number type erspan-source</code>	Enters the monitor configuration mode for the ERSPAN source type. The new session

	Command or Action	Purpose
		configuration is added to the existing session configuration.
Step 5	switch(config-erspan-src)# monitor session <i>session-number</i> type erspan-destination	Enters the monitor configuration mode for the ERSPAN destination type.
Step 6	switch(config-erspan-src)# shut	Shuts down the ERSPAN session. By default, the session is created in the shut state.
Step 7	switch(config-erspan-src)# no shut	Enables the ERSPAN session. By default, the session is created in the shut state.
Step 8	switch(config-erspan-src)# exit	Exits the monitor configuration mode.
Step 9	(Optional) switch(config)# show monitor session all	Displays the status of ERSPAN sessions.
Step 10	(Optional) switch(config)# show running-config monitor	Displays the ERSPAN running configuration.
Step 11	(Optional) switch(config)# show startup-config monitor	Displays the ERSPAN startup configuration.
Step 12	(Optional) switch(config)# copy running-config startup-config	Copies the running configuration to the startup configuration.

16.7.4 Configuring MTU Truncation for Each ERSPAN Session

Beginning with Inspur INOS Release 6.1, in order to reduce the ERSPAN traffic bandwidth, you can configure the maximum bytes allowed for each replicated packet in an ERSPAN session. This value is called the maximum transmission unit (MTU) truncation size. Any ERSPAN packet larger than the configured size is truncated to the configured size.

Before you begin

Ensure that you are in the correct VDC (or use the switchto vdc command).

Procedure

	Command or Action	Purpose
Step 1	switch# configure terminal	Enters global configuration mode.
Step 2	switch(config)# monitor session <i>session-number</i> type erspan-source	Enters the monitor configuration mode for the ERSPAN source type and specifies the ERSPAN session for which the MTU truncation size is to be configured.
Step 3	(Optional) switch(config-erspan-src)# header-type <i>version</i>	Changes the ERSPAN source session from Type II to Type III.
Step 4	switch(config-erspan-src)# [no] mtu <i>mtu</i>	Configures the MTU truncation size for packets in the specified ERSPAN session. The range is from 176 to 1500 bytes.
Step 5	switch(config-erspan-src)# exit	Exits monitor configuration mode.
Step 6	switch(config)# exit	Exits global configuration mode.
Step 7	(Optional) switch# show monitor session <i>session-number</i>	Displays the status of ERSPAN sessions, including the configuration status of MTU truncation, the maximum bytes allowed for each packet per session, and the modules on which MTU truncation is and is not supported.
Step 8	(Optional) switch# copy running-config	Copies the running configuration to the startup

	Command or Action	Purpose
	startup-config [vdc-all]	configuration.

16.7.5 Configuring a Source Rate Limit for Each ERSPAN Session

When an ERSPAN session is configured with multiple interfaces as the sources in a high-traffic environment, the destination port can be overloaded, causing the normal data traffic to be disrupted at the source port.

Beginning with Inspur INOS Release 6.1, you can alleviate this problem as well as traffic overload on the source forwarding instance by configuring a source rate limit for each ERSPAN session.

Procedure

	Command or Action	Purpose
Step 1	switch# configure terminal	Enters global configuration mode.
Step 2	switch(config)# monitor session session-number type erspan-source	Enters the monitor configuration mode for the ERSPAN source type and specifies the ERSPAN session for which the source rate limit is to be configured.
Step 3	(Optional) switch(config-erspan-src)# header-type version	Changes the ERSPAN source session from Type II to Type III.
Step 4	switch(config-erspan-src)# [no] rate-limit {auto rate-limit}	Configures the source rate limit for ERSPAN packets in the specified ERSPAN session in automatic or manual mode: <ul style="list-style-type: none"> Auto mode—Automatically calculates the rate limit on a per-gigabyte basis as follows: destination bandwidth / aggregate source bandwidth. For example, if the rate limit per gigabyte is 0.5, for every 1G of source traffic, only 0.5G of packets are spanned. For ingress traffic, the per-gigabyte limit is applied to each forwarding engine of the F2 Series or F2e Series module based on how many ports are used as the ERSPAN source so that the source can be spanned at the maximum available bandwidth. For egress traffic, the per-gigabyte limit is applied to each forwarding engine of the F2 Series or F2e Series module without considering how many ports are used as the ERSPAN source. Manual mode—Specifies the percentage of the maximum rate of ERSPAN packets that can be sent out from each forwarding engine on a module. The range is from 1 to 100. For example, if the rate limit is 10 percent, the maximum rate of ERSPAN packets that can be sent out from each of the forwarding engines on an F2 Series or F2e Series module is 1G (or 10 percent of the 10G line rate).
Step 5	switch(config-erspan-src)# exit	Exits monitor configuration mode.
Step 6	switch(config)# exit	Exits global configuration mode.

	Command or Action	Purpose
Step 7	(Optional) switch# show monitor session <i>session-number</i>	Displays the status of ERSPAN sessions, including the configuration status of the rate limit, the percentage of the maximum ERSPAN rate allowed per session, and the modules on which the rate limit is and is not supported.
Step 8	(Optional) switch# copy running-config startup-config [vdc-all]	Copies the running configuration to the startup configuration.

16.7.6 Configuring Sampling for Each ERSPAN Session

Beginning with Inspur INOS Release 6.1, you can configure a sampling range for spanned traffic in order to reduce the ERSPAN traffic bandwidth and to monitor peer-to-peer traffic. Packet range-based sampling is used to provide an accurate count of the ERSPAN source packets.

Before you begin

Ensure that you are in the correct VDC (or use the `switchto vdc` command).

Procedure

	Command or Action	Purpose
Step 1	switch# configure terminal	Enters global configuration mode.
Step 2	switch(config)# monitor session <i>session-number</i> type erspan-source	Enters the monitor configuration mode for the ERSPAN source type and specifies the ERSPAN session for which ERSPAN sampling is to be configured.
Step 3	(Optional) switch(config-erspan-src)# header-type version	Changes the ERSPAN source session from Type II to Type III.
Step 4	switch(config-erspan-src)# [no] sampling range	Configures the sampling range for ERSPAN source packets. The sampling value is the range in which one packet out of x packets will be spanned, where x is from 2 to 1023. In this example, 1 out of every 100 packets will be spanned.
Step 5	switch(config-erspan-src)# exit	Exits monitor configuration mode.
Step 6	switch(config)# exit	Exits global configuration mode.
Step 7	(Optional) switch# show monitor session <i>session-number</i>	Displays the status of ERSPAN sessions, including the configuration status of ERSPAN sampling, the sampling value, and the modules on which sampling is and is not supported.
Step 8	(Optional) switch# copy running-config startup-config [vdc-all]	Copies the running configuration to the startup configuration.

16.7.7 Configuring the Multicast Best Effort Mode for an ERSPAN Session

You can configure the multicast best effort mode for any ERSPAN session. By default, ERSPAN replication occurs on both the ingress and egress modules. When you enable the multicast best effort mode, ERSPAN replication occurs only on the ingress module for multicast traffic or on the egress module for packets that egress out of Layer 3 interfaces (that is, on the egress module, packets that egress out of Layer 2 interfaces are not replicated for ERSPAN).

Before you begin

Ensure that you are in the correct VDC (or use the `switchto vdc` command).

Procedure

	Command or Action	Purpose
Step 1	<code>switch# configure terminal</code>	Enters global configuration mode.
Step 2	<code>switch(config)# monitor session <i>session-number</i> type erspan-source</code>	Enters the monitor configuration mode for the ERSPAN source type and specifies the ERSPAN session for which the multicast best effort mode is to be configured.
Step 3	(Optional) <code>switch(config-erspan-src)# header-type <i>version</i></code>	Changes the ERSPAN source session from Type II to Type III.
Step 4	<code>switch(config-erspan-src)# [no] multicast best-effort</code>	Configures the multicast best effort mode for the specified ERSPAN session.

16.7.8 Configuring Rule-Based ERSPAN

You can configure filters for ingress or egress ERSPAN traffic based on a set of rules. A simple filter has only one rule, and multiple fields or conditions can be added to this rule. The packets are spanned only if all conditions are met.

Before you begin

Ensure that you are in the correct VDC (or use the `switchto vdc` command).

Procedure

	Command or Action	Purpose
Step 1	<code>switch# configure terminal</code>	Enters global configuration mode.
Step 2	<code>switch(config)# monitor erspan origin ip-address <i>ip-address</i> global</code>	Configures the ERSPAN global origin IP address. The global origin IP address can be configured in either the default VDC or the admin VDC. The value that is configured in this VDC is valid across all VDCs. Any change made in the default or admin VDC is applied across all nondefault VDCs.
Step 3	(Optional) <code>switch(config)# monitor erspan granularity {100_ms 100_ns 1588 ns}</code>	Specifies the granularity of all ERSPAN Type III sessions across all VDCs. The granularity options are 100 microseconds (ms), 100 nanoseconds (ns), IEEE 1588 (in seconds or nanoseconds), and nanoseconds. Note The clock manager adjusts the ERSPAN timers based on the granularity setting. If you configure IEEE 1588, the clock manager synchronizes the ERSPAN timers across switches. Otherwise, the clock manager synchronizes the ERSPAN timer with the master timer in the switch.

	Command or Action	Purpose
		<p>Note 1588 granularity mode is not supported in Inspur INOS Release 6.1 and is rejected if selected.</p> <p>Note This command can be applied only in the default VDC.</p>
Step 4	switch(config)# no monitor session { <i>session-number</i> all }	Clears the configuration of the specified ERSPAN session. The new session configuration is added to the existing session configuration.
Step 5	switch(config)# monitor session { <i>session-number</i> all } type erspan-source [rx tx] [shut]	<p>Configures an ERSPAN Type II source session. By default the session is bidirectional. The optional keywords are as follows:</p> <ul style="list-style-type: none"> rx—Specifies an ingress extended ERSPAN source session. tx—Specifies an egress extended ERSPAN source session. shut—Specifies a shut state for the selected session.
Step 6	(Optional) switch(config-erspan-src)# mode extended	<p>Configures the ERSPAN source session as an extended bidirectional session.</p> <p>Note You cannot use this command on a unidirectional ERSPAN source session.</p>
Step 7	(Optional) switch(config-erspan-src)# header-type version	<p>Changes the ERSPAN source session from Type II to Type III.</p> <p>Note You can use the no form of this command to change an ERSPAN source session from Type III to Type II.</p>
Step 8	(Optional) switch(config-erspan-src)# description <i>description</i>	Configures a description for the session. By default, no description is defined. The description can be up to 32 alphanumeric characters.
Step 9	switch(config-erspan-src)# [no] filter [access-group <i>acl-filter</i>] [vlan <i>vlan-range</i>] [bpdu [true false]] [cos <i>cos-value</i>] [dest-mac <i>dest-mac</i>] [eth-type <i>eth-value</i>] [flow-hash <i>flow-value</i>] [frame-type [eth arp fcoe ipv4 ipv6]] [pc-lane <i>port-number</i>] [src_mac <i>mac-address</i>] [trace-route [true false]]	<p>Configures the filter for the ERSPAN session. To remove the filter from the session, enter the no form of the command. The optional keywords are as follows:</p> <ul style="list-style-type: none"> access-group—Specifies a filter based on an access control group. vlan—Specifies a filter based on a VLAN range. bpdu—Specifies a filter based on the bridge protocol data unit (BPDU) class of packets. cos—Specifies a filter based on the class of service (CoS) in the dot1q header. dest-mac—Specifies a filter based on a destination MAC address. eth-type—Specifies a filter based on the Ethernet type. flow-hash—Specifies a filter based on the

	Command or Action	Purpose
		result bundle hash (RBH) value. <ul style="list-style-type: none"> • frame-type—Specifies a filter based on a frame type. • pc-lane—Specifies a filter based on a member of the port channel. • src-mac—Specifies a filter based on a source MAC address. • trace-route—Specifies a filter based on the route bit in the header.
Step 10	(Optional) switch(config-erspan-src)# [no] filter frame-type eth	Configures the Ethernet frame type filter for the ERSPAN session. To remove the filter from the session, enter the no form of the command.
Step 11	(Optional) switch(config-erspan-src)# [no] filter frame-type arp [[arp-rarp [arp rarp]] [req-resp [req rsp]] [sender-ip ip-address] [target-ip ip-address]]	Configures the ARP frame type filter for the ERSPAN session. To remove the filter from the session, enter the no form of the command. <ul style="list-style-type: none"> • arp-rarp—Specifies an ARP or RARP frame type filter. • req-resp—Specifies a filter based on a request or response. • sender-ip—Specifies a filter based on a sender IP address. • target-ip—Specifies a filter based on a target IP address.
Step 12	(Optional) switch(config-erspan-src)# [no] filter frame-type fcoe [[fc-sid FC-source-ID] [fc-did FC-dest-ID] [fcoe-type fcoe-value] [r-ctl r-ctl-value] [sof sof-value] [cmd-code cmd-value]]	Configures the FCoE frame type filter for the ERSPAN session. To remove the filter from the session, enter the no form of the command. The optional keywords are as follows: <ul style="list-style-type: none"> • fc-sid—Specifies a filter based on an FC source ID. • fc-did—Specifies a filter based on an FC destination ID. • fcoe-type—Specifies a filter based on an FCoE type. • r-ctl—Specifies a filter based on the routing control flags (R CTL) value. • sof—Specifies a filter based on the start of frame (SOF) packets. • cmd-code—Specifies a filter based on a command code.
Step 13	(Optional) switch(config-erspan-src)# [no] filter frame-type ipv4 [[src-ip src-ip] [dest-ip dest-ip] [tos tos-value] [l4-protocol l4-value]]	Configures the IPv4 frame type filter for the ERSPAN session. To remove the filter from the session, enter the no form of the command. The optional keywords are as follows: <ul style="list-style-type: none"> • src-ip—Specifies a filter based on an IPv4 source IP address. • dest-ip—Specifies a filter based on an IPv4 destination IP address. • tos—Specifies a filter based on the type of service (ToS) in the IP header. • l4-protocol—Specifies a filter based on

	Command or Action	Purpose
		a Layer 4 protocol number set in the protocol field of the IP header.
Step 14	(Optional) <code>switch(config-erspan-src)# [no] filter frame-type ipv6 [[src-ip src-ip] [dest-ip dest-ip] [tos tos-value] [l4-protocol l4-value]]</code>	Configures the IPv6 frame type filter for the ERSPAN session. To remove the filter from the session, enter the no form of the command. The optional keywords are as follows: <ul style="list-style-type: none"> • src-ip—Specifies a filter based on an IPv6 source IP address. • dest-ip—Specifies a filter based on an IPv6 destination IP address. • tos—Specifies a filter based on the type of service (ToS) in the IP header. • l4-protocol—Specifies a filter based on a Layer 4 protocol number set in the protocol field of the IP header.
Step 15	(Optional) Repeat Steps 9 to 14 for all filters for the session.	—
Step 16	<code>switch(config-erspan-src)# source {[interface [type slot/port [-port] [,type slot/port[-port]]] [port-channel channel-number]} [vlan {number range}]} [rx tx both]</code>	Configures sources and the traffic direction in which to copy packets. You can enter a range of Ethernet ports, a port channel, an inband interface, a range of VLANs, a Inspur CN3000 Series Fabric Extender interface, or a fabric port channel connected to a Inspur CN3000 Series Fabric Extender. You can configure one or more sources, as either a series of comma-separated entries or a range of numbers. You can specify up to 128 interfaces. The VLAN range is from 1 to 3967. The VLAN range of 4048 to 4093 is also supported for Inspur INOS releases prior to 6.1. You can specify the traffic direction to copy as ingress (rx), egress (tx) , or both. By default, the direction is both. For a unidirectional session, the direction of the source must match the direction specified in the session.
Step 17	(Optional) Repeat Step 16 to configure all ERSPAN sources.	—
Step 18	<code>switch(config-erspan-src)# destination ip ip-address</code>	Configures the destination IP address in the ERSPAN session. Only one destination IP address is supported per ERSPAN source session. Note The Inspur CN3000 Series Fabric Extender interfaces and the fabric port channels connected to the FEX cannot be configured as ERSPAN destinations.
Step 19	<code>switch(config-erspan-src)# erspan-id erspan-id</code>	Configures the ERSPAN ID for the ERSPAN session. The ERSPAN range is from 1 to 1023.
Step 20	<code>switch(config-erspan-src)# vrf vrf-name</code>	Configures the VRF instance that the ERSPAN

	Command or Action	Purpose
		source session uses for traffic forwarding. The VRF name can be any case-sensitive, alphanumeric string up to 32 characters.
Step 21	(Optional) switch(config-erspan-src)# ip ttl <i>ttl-number</i>	Configures the IP time-to-live (TTL) value for the ERSPAN traffic. The range is from 1 to 255.
Step 22	(Optional) switch(config-erspan-src)# ip dscp <i>dscp-number</i>	Configures the differentiated services code point (DSCP) value of the packets in the ERSPAN traffic. The range is from 0 to 63.
Step 23	switch(config-erspan-src)# no shut	Enables the ERSPAN session. By default, the session is created in the shut state.
Step 24	switch(config-erspan-src)# exit	Exits monitor configuration mode.
Step 25	switch(config)# exit	Exits global configuration mode.
Step 26	(Optional) switch# show monitor session { all <i>session-number</i> range session-range } [brief]	Displays the status of ERSPAN sessions, including the configuration status of the multicast best effort mode and the modules on which the best effort mode is and is not supported.
Step 27	(Optional) switch# copy running-config startup-config	Copies the running configuration to the startup configuration.

16.7.9 Configuring Exception ERSPAN

You can configure the device to span exception packets.

Before you begin

Ensure that you are in the correct VDC (or use the `switchto vdc` command).

Procedure

	Command or Action	Purpose
Step 1	switch# configure terminal	Enters global configuration mode.
Step 2	switch(config)# monitor session <i>session-number</i> type erspan-source [rx tx] [shut]	Enters the monitor configuration mode and specifies the ERSPAN session. The exception ERSPAN is supported in the egress direction only. In the case of an extended ERSPAN Rx session, the exception source configuration will be rejected. The optional keywords are as follows: <ul style="list-style-type: none"> rx—Specifies an ingress extended ERSPAN source session. tx—Specifies an egress extended ERSPAN source session. shut—Specifies a shut state for the selected session.
Step 3	(Optional) switch(config-erspan-src)# mode extended	Configures the ERSPAN session as an extended bidirectional session.
Step 4	switch(config-erspan-src)# source exception { layer3 fabricpath other all }	Configures the source as an exception ERSPAN session. These exception types are supported: <ul style="list-style-type: none"> layer3—Specifies the Layer 3 exception

	Command or Action	Purpose
		type for F2 Series and M Series modules. <ul style="list-style-type: none"> • fabricpath—Specifies the FabricPath exception type for F Series modules. • other—Specifies exceptions for M Series modules that are dropped through redirect registers programmed with a drop destination interface. • all—Includes all Layer 3, FabricPath, and other exceptions.
Step 5	switch(config-erspan-src)# destination ip <i>ip-address</i>	Configures the destination IP address in the ERSPAN session. Only one destination IP address is supported per ERSPAN source session. Note The Inspur CN3000 Series Fabric Extender interfaces and the fabric port channels connected to the FEX cannot be configured as ERSPAN destinations.
Step 6	switch(config-erspan-src)# no shut	Enables the ERSPAN session. By default, the session is created in the shut state.
Step 7	switch(config-erspan-src)# exit	Exits module configuration mode.
Step 8	switch(config)# exit	Exits global configuration mode.
Step 9	(Optional) switch# show monitor session <i>session-number</i>	Displays the status of ERSPAN sessions, including the configuration status of the multicast best effort mode and the modules on which the best effort mode is and is not supported.
Step 10	(Optional) switch# copy running-config startup-config [<i>vdc-all</i>]	Copies the running configuration to the startup configuration.

16.8 Verifying the ERSPAN Configuration

To display the ERSPAN configuration, perform one of the following tasks:

Command	Purpose
show monitor session { <i>all</i> <i>session-number</i> <i>range</i> <i>session-range</i> } [<i>brief</i>]	Displays the ERSPAN session configuration.
show running-config monitor	Displays the running ERSPAN configuration.
show startup-config monitor	Displays the ERSPAN startup configuration.
show resource monitor-session-extended	Displays the resources that are available for the extended session.
show resource monitor-session-mx-exception-src	Displays the resources that are available for the exception session.

For detailed information about the fields in the output from these commands, see the *Inspur CN12700 Series INOS System Management Command Reference*.

16.9 Configuration Examples for ERSPAN

16.9.1.1 Configuration Example for an ERSPAN Type III Source Session

This example shows how to configure an ERSPAN Type III source session:

```
switch# configure terminal
switch(config)# interface ethernet 14/30
switch(config-if)# no shut
switch(config-if)# exit
switch(config)# monitor erspan origin ip-address 3.3.3.3 global
switch(config)# monitor erspan granularity 100_ns
switch(config)# monitor session 1 type erspan-source
switch(config-erspan-src)# mode extended
switch(config-erspan-src)# header-type 3
switch(config-erspan-src)# source interface ethernet 14/30
switch(config-erspan-src)# erspan-id 1
switch(config-erspan-src)# ip ttl 16
switch(config-erspan-src)# ip dscp 5
switch(config-erspan-src)# vrf default
switch(config-erspan-src)# destination ip 9.1.1.2
switch(config-erspan-src)# no shut
switch(config-erspan-src)# exit
switch(config)# show monitor session 1
```

16.9.2 Configuration Example to Monitor All VLANs and Ports in an Extended ERSPAN Monitor Session

This example shows how to monitor all VLANs and ports in an extended ERSPAN monitor session:

```
switch# configure terminal
switch(config)# monitor session 1 type erspan-source
switch(config-monitor)# mode extended
switch(config-monitor)# source interface all
switch(config-monitor)# destination interface ethernet 14/29
switch(config-monitor)# vrf default
switch(config-monitor)# erspan-id 200
switch(config-monitor)# no shut
switch(config-monitor)# exit
switch(config)# show monitor session 1
switch(config)# copy running-config startup-config
```

This example shows how to monitor a higher number of specific VLAN sources than the VLAN source limits currently supported in an extended ERSPAN monitor session:

```
switch# configure terminal
switch(config)# monitor session 2 type erspan-source
switch(config-monitor)# mode extended
switch(config-monitor)# source interface all tx
switch(config-monitor)# destination ip 192.0.2.1
switch(config-monitor)# vrf default
switch(config-monitor)# erspan-id 200
switch(config-monitor)# filter vlan 1-1000
switch(config-monitor)# no shut
switch(config-monitor)# exit
switch(config)# show monitor session 2
switch(config)# copy running-config startup-config
```

16.9.3 Configuration Example for a Unidirectional ERSPAN Session

This example shows how to configure a unidirectional ERSPAN session:

```
switch# configure terminal
switch(config)# interface ethernet 14/30
switch(config-if)# no shut
switch(config-if)# exit
switch(config)# no monitor session 3
switch(config)# monitor session 3 rx
switch(config-erspan-src)# source interface ethernet 2/1-3 rx
switch(config-erspan-src)# erspan-id 1
switch(config-erspan-src)# ip ttl 16
switch(config-erspan-src)# ip dscp 5
switch(config-erspan-src)# vrf default
switch(config-erspan-src)# destination ip 9.1.1.2
switch(config-erspan-src)# no shut
switch(config-erspan-src)# exit
switch(config)# show monitor session 1
```

16.9.4 Configuration Example for an ERSPAN Destination Session

This example shows how to configure an ERSPAN destination session:

```
switch# configure terminal
switch(config)# interface e14/29
switch(config-if)# no shut
switch(config-if)# switchport
switch(config-if)# switchport monitor
switch(config-if)# exit
switch(config)# monitor session 2 type erspan-destination
switch(config-erspan-dst)# source ip 9.1.1.2
switch(config-erspan-dst)# destination interface e14/29
switch(config-erspan-dst)# erspan-id 1
switch(config-erspan-dst)# vrf default
switch(config-erspan-dst)# no shut
switch(config-erspan-dst)# exit
switch(config)# show monitor session 2
```

16.9.5 Configuration Example for an ERSPAN ACL

This example shows how to configure an ERSPAN ACL:

```
switch# configure terminal
switch(config)# ip access-list match_11_pkts
switch(config-acl)# permit ip 11.0.0.0 0.255.255.255 any
switch(config-acl)# exit
switch(config)# ip access-list match_12_pkts
switch(config-acl)# permit ip 12.0.0.0 0.255.255.255 any
switch(config-acl)# exit
switch(config)# vlan access-map erspan_filter 5
switch(config-access-map)# match ip address match_11_pkts
switch(config-access-map)# action forward
switch(config-access-map)# exit
switch(config)# vlan access-map erspan_filter 10
switch(config-access-map)# match ip address match_12_pkts
switch(config-access-map)# action forward
switch(config-access-map)# exit
switch(config)# monitor session 1 type erspan-source
switch(config-erspan-src)# header-type 3
```

```
switch(config-erspan-src)# filter access_group erspan_filter
```

16.9.6 Configuration Example for ERSPAN with MTU Truncation and ERSPAN Sampling

This example shows how to configure MTU truncation and ERSPAN sampling for an ERSPAN session:

```
switch# configure terminal
switch(config)# monitor session 1 type erspan-source
switch(config-erspan-src)# mtu 100
switch(config-erspan-src)# sampling 10
switch(config-erspan-src)# show monitor session 1
```

16.9.7 Configuration Example for ERSPAN Using the Multicast Best Effort Mode

This example shows how to configure the multicast best effort mode for an ERSPAN session:

```
switch# configure terminal
switch(config)# monitor session 1 type erspan-source
switch(config-erspan-src)# multicast best-effort
switch(config-erspan-src)# show monitor session 1
```

16.9.8 Configuration Example for Rule-Based ERSPAN

This example shows how to configure a rule-based ERSPAN session:

```
switch# configure terminal
switch(config)# monitor erspan origin ip-address 10.0.0.1 global
switch(config)# monitor erspan granularity 100_ns
switch(config)# no monitor session 3
switch(config)# monitor session 3 type erspan-source
switch(config-erspan-src)# mode extended
switch(config-erspan-src)# header-type 3
switch(config-erspan-src)# description erspan_src_session_3
switch(config-erspan-src)# filter frame-type ipv4 src-ip 10.1.1.1/24
switch(config-erspan-src)# filter vlan 10,20
switch(config-erspan-src)# source interface ethernet 2/1-3, ethernet 3/1 rx
switch(config-erspan-src)# destination ip 10.1.1.1
switch(config-erspan-src)# erspan-id 5
switch(config-erspan-src)# vrf default
switch(config-erspan-src)# ip ttl 25
switch(config-erspan-src)# ip dscp 42
switch(config-erspan-src)# no shut
switch# show monitor session 3
```

16.9.9 Configuration Example for Exception ERSPAN

This example shows how to configure an exception ERSPAN session:

```
switch# configure terminal
switch(config)# monitor session 3 type erspan-source
switch(config-erspan-src)# mode extended
switch(config-erspan-src)# source exception all
switch(config-erspan-src)# destination ip 10.1.1.1
switch(config-erspan-src)# no shut
switch# show monitor session 3
```

16.10 Related Documents

Related Topic	Document Title
ERSPAN commands: complete command syntax, command modes, command history, defaults, usage guidelines, and examples	<i>Inspur CN12700 Series INOS System Management Command Reference</i>
VDCs	<i>Inspur CN12700 Series INOS Virtual Device Context Configuration Guide</i>
Inspur Network Analysis Module (NAM)	<i>Inspur Network Analysis Module (NAM) for CN12700 Quick Start Guide</i>
Fabric Extender	<i>Inspur CN3000 Series Fabric Extender Software Configuration Guide</i>

16.11 Feature History for ERSPAN

The table below summarizes the new and changed features for this document and shows the releases in which each feature is supported. Your software release might not support all the features in this document. For the latest caveats and feature information, the release notes for your software release.

Table 36: Feature History for ERSPAN

Feature Name	Releases	Feature Information
ERSPAN	7.3(0)DX(1)	Added support for ERSPAN source and destination sessions on M3 Series modules.
ERSPAN	7.3(0)D1(1)	Added support for 4K VLANs per ERSPAN Session.
ERSPAN	6.2(2)	Added support for ERSPAN destination sessions on F2 and F2e Series modules.
ERSPAN	6.2(2)	Added NAM support for ERSPAN data sources.
ERSPAN	6.2(2)	Added support for extended ERSPAN.
ERSPAN	6.2(2)	Added support for rule-based ERSPAN.
ERSPAN	6.2(2)	Added support for exception ERSPAN.
ERSPAN	6.2(2)	Added support for ERSPAN termination on F2 or F2e Series modules.
ERSPAN	6.1(2)	Added support for F2e Series modules.
ERSPAN	6.1(1)	Added support for ERSPAN Type III.
ERSPAN	6.1(1)	Added support for Supervisor 2.
ERSPAN	6.1(1)	Added support for F2 and M2 Series modules.
ERSPAN	6.1(1)	Added support for ERSPAN sampling.
ERSPAN	6.1(1)	Added the ability to configure MTU truncation and the source rate limit for each ERSPAN session.
ERSPAN	6.0(1)	ERSPAN and ERSPAN ACLs are not supported on F2 Series modules.
ERSPAN	5.2(1)	Added ERSPAN source support for Inspur CN3000 Series Fabric Extender interfaces.
ERSPAN	5.2(1)	Added the ability to configure the multicast best effort mode for an ERSPAN session.
ERSPAN and ERSPAN ACLs	5.1(1)	This feature was introduced.
ERSPAN	7.2	ERSPAN source sessions are supported on F3 Series modules. However, ERSPAN ACL sessions are not supported on F3 Series modules.

CHAPTER 17 Configuring LLDP

This chapter describes how to configure the Link Layer Discovery Protocol (LLDP) in order to discover other devices on the local network.

This chapter includes the following sections:

- Finding Feature Information
- About LLDP
- Licensing Requirements for LLDP
- Guidelines and Limitations for LLDP
- Default Settings for LLDP
- Configuring LLDP
- Verifying the LLDP Configuration
- Configuration Example for LLDP
- Related Documents
- Feature History for LLDP

17.1 Finding Feature Information

Your software release might not support all the features documented in this module. For the latest caveats and feature information, the release notes for your software release. To find information about the features documented in this module, and to see a list of the releases in which each feature is supported, see the "New and Changed Information" chapter or the Feature History table in this chapter.

17.2 About LLDP

The Inspur Discovery Protocol (CDP) is a device discovery protocol that allows network management applications to automatically discover and learn about other Inspur devices that are connected to the network.

To permit the discovery of non-Inspur devices, the switch also supports the Link Layer Discovery Protocol (LLDP), a vendor-neutral device discovery protocol that is defined in the IEEE 802.1ab standard. LLDP allows network devices to advertise information about themselves to other devices on the network. This protocol runs over the data-link layer, which allows two systems running different network layer protocols to learn about each other.

LLDP is a one-way protocol that transmits information about the capabilities and status of a device and its interfaces. LLDP devices use the protocol to solicit information only from other LLDP devices.

LLDP supports a set of attributes that it uses to discover other devices. These attributes contain type, length, and value (TLV) descriptions. LLDP devices can use TLVs to send and receive information to other devices on the network. Details such as configuration information, device capabilities, and device identity can be advertised using this protocol.

LLDP advertises the following TLVs by default:

- DCBXP
- Management address
- Port description
- Port VLAN
- System capabilities
- System description
- System name

17.2.1 About DCBXP

The Data Center Bridging Exchange Protocol (DCBXP) is an extension of LLDP. It is used to announce, exchange, and negotiate node parameters between peers. DCBXP parameters are packaged into a specific DCBXP TLV. This TLV is designed to provide an acknowledgement to the received LLDP packet. In this way, DCBXP adds a lightweight acknowledgement mechanism on top of LLDP so that any application that needs a request-response semantic from a link-level protocol can make use of DCBXP.

Other applications that need to exchange and negotiate parameters with peer nodes using DCBXP are as follows:

- Priority-based Flow Control (PFC)—PFC is an enhancement to the existing Pause mechanism in Ethernet. It enables Pause based on user priorities or classes of service. A physical link divided into eight virtual links with PFC provides the capability to use Pause on a single virtual link without affecting traffic on the other virtual links. Enabling Pause on a per-user-priority basis allows administrators to create lossless links for traffic requiring no-drop service while retaining packet-drop congestion management for IP traffic.

- Enhanced Transmission Selection (ETS)—ETS enables optimal bandwidth management of virtual links. ETS is also called priority grouping. It enables differentiated treatments within the same priority classes of PFC. ETS provides prioritized processing based on bandwidth allocation, low latency, or best effort, resulting in per-group traffic class allocation. For example, an Ethernet class of traffic may have a

high-priority designation and a best effort within that same class. ETS allows differentiation between traffic of the same priority class, thus creating priority groups.

- Application Priority Configuration TLV—Carries information about which VLANs will be used by specific protocols.

DCBXP is enabled by default, provided LLDP is enabled. When LLDP is enabled, DCBXP can be enabled or disabled using the `[no] lldp tlv-select dcbxp` command. DCBXP is disabled on ports where LLDP transmit or receive is disabled.

17.2.2 High Availability

The LLDP feature supports stateless and stateful restarts. After a reboot or supervisor switchover, the running configuration is applied.

For more information on high availability, see the *Inspur CN12700 Series INOS High Availability and Redundancy Guide*.

17.2.3 Virtualization Support

One instance of LLDP is supported.

17.3 Licensing Requirements for LLDP

Product	License Requirement
Inspur INOS	LLDP requires no license. Any feature not included in a license package is bundled with the INOS image and is provided at no extra charge to you. For a complete explanation of the Inspur INOS licensing scheme, see the <i>Inspur INOS Licensing Guide</i> .

17.4 Guidelines and Limitations for LLDP

LLDP has the following configuration guidelines and limitations:

- LLDP must be enabled on the device before you can enable or disable it on any interfaces.
- LLDP is supported only on physical interfaces.
- LLDP can discover up to one device per port.
- LLDP can discover Linux servers, provided they are not using a converged network adapter (CNA). LLDP cannot discover other types of servers.

- DCBXP incompatibility messages might appear when you change the network QoS policy if a physical loopback connection is in the device. The incompatibility exists for only a short time and then clears.
- DCBXP is not supported for the Inspur CN3000 Series Fabric Extender.
- Beginning with Inspur INOS Release 5.2, LLDP is supported for the Inspur CN3000 Series Fabric Extender. LLDP packets can now be sent and received through the Fabric Extender ports for neighbor discovery.
- All LLDP configuration on Fabric Extender ports occurs on the supervisor. LLDP configuration and show commands are not visible on the Fabric Extender console.
- LLDP is not supported for a Fabric Extender-virtual port channel (vPC) connection.

17.5 Default Settings for LLDP

This table lists the LLDP default settings.

Parameters	Default
Global LLDP	Disabled
LLDP on interfaces	Enabled, after LLDP is enabled globally
LLDP hold time (before discarding)	120 seconds
LLDP reinitialization delay	2 seconds
LLDP timer (packet update frequency)	30 seconds
LLDP TLVs	Enabled
LLDP receive	Enabled, after LLDP is enabled globally
LLDP transmit	Enabled, after LLDP is enabled globally
DCBXP	Enabled, provided LLDP is enabled

17.6 Configuring LLDP

17.6.1 Enabling or Disabling LLDP Globally

You can enable or disable LLDP globally on a device. You must enable LLDP globally to allow a device to send and receive LLDP packets.

Procedure

	Command or Action	Purpose
Step 1	switch# configure terminal	Enters global configuration mode.
Step 2	switch(config)# [no] feature lldp	Enables or disables LLDP on the device. LLDP is disabled by default.
Step 3	(Optional) switch(config)# show running-config lldp	Displays the global LLDP configuration. If LLDP is enabled, it shows "feature lldp." If LLDP is disabled, it shows an "Invalid command" error.
Step 4	(Optional) switch(config)# copy running-config startup-config	Copies the running configuration to the startup configuration.

17.6.2 Enabling or Disabling LLDP on an Interface

After you globally enable LLDP, it is enabled on all supported interfaces by default. However, you can enable or disable LLDP on individual interfaces or selectively configure an interface to only send or only receive LLDP packets.

Before you begin

Make sure that you have globally enabled LLDP on the device.

Procedure

	Command or Action	Purpose
Step 1	switch# configure terminal	Enters global configuration mode.
Step 2	switch(config)# interface <i>interface slot/port</i>	Specifies the interface on which you are enabling LLDP and enters the interface configuration mode.
Step 3	switch(config-if)# [no] lldp transmit	Enables or disables the transmission of LLDP packets on an interface. After you globally enable LLDP, it is enabled on all supported interfaces by default.
Step 4	switch(config-if)# [no] lldp receive	Enables or disables the reception of LLDP packets on an interface. After you globally enable LLDP, it is enabled on all supported interfaces by default.
Step 5	(Optional) switch(config-if)# show lldp interface <i>interface slot/port</i>	Displays the LLDP configuration on the interface.
Step 6	(Optional) switch(config)# copy running-config startup-config	Copies the running configuration to the startup configuration.

17.6.3 Configuring Optional LLDP Parameters

You can configure the frequency of LLDP updates, the amount of time for a receiving device to hold the information before discarding it, and the initialization delay time. You can also select the TLVs to include in LLDP packets.

Procedure

	Command or Action	Purpose
Step 1	switch# configure terminal	Enters global configuration mode.
Step 2	(Optional) switch(config)# [no] lldp holdtime <i>seconds</i>	Specifies the amount of time in seconds that a receiving device should hold the information sent by your device before discarding it. The range is 10 to 255 seconds; the default is 120 seconds.
Step 3	(Optional) switch(config)# [no] lldp reinit <i>seconds</i>	Specifies the delay time in seconds for LLDP to initialize on any interface. The range is 1 to 10 seconds; the default is 2 seconds.
Step 4	(Optional) switch(config)# [no] lldp timer <i>seconds</i>	Specifies the transmission frequency of LLDP updates in seconds. The range is 5 to 254 seconds; the default is 30 seconds.
Step 5	(Optional) switch(config)# show lldp timers	Displays the LLDP hold time, delay time, and update frequency configuration.
Step 6	(Optional) switch(config)# [no] lldp tlv-select <i>tlv</i>	Specifies the TLVs to send and receive in LLDP packets. The available TLVs are debxp, management-address, port-description,

	Command or Action	Purpose
		port-vlan, system-capabilities, system-description, and system-name. All available TLVs are enabled by default.
Step 7	(Optional) switch(config)# show lldp tlv-select	Displays the LLDP TLV configuration.
Step 8	(Optional) switch(config)# copy running-config startup-config	Copies the running configuration to the startup configuration.

17.7 Verifying the LLDP Configuration

To display the LLDP configuration, perform one of the following tasks:

Command	Purpose
show running-config lldp	Displays the global LLDP configuration.
show lldp interface <i>interface slot/port</i>	Displays the LLDP interface configuration.
show lldp timers	Displays the LLDP hold time, delay time, and update frequency configuration.
show lldp tlv-select	Displays the LLDP TLV configuration.
show lldp dcbox interface <i>interface slot/port</i>	Displays the local DCBX control status.
show lldp neighbors { detail interface <i>interface slot/port</i> }	Displays the LLDP neighbor device status.
show lldp traffic	Displays the LLDP counters, including the number of LLDP packets sent and received by the device, the number of discarded packets, and the number of unrecognized TLVs.
show lldp traffic interface <i>interface slot/port</i>	Displays the number of LLDP packets sent and received on the interface.

Use the `clear lldp counters` command to clear the LLDP statistics.

17.8 Configuration Example for LLDP

This example shows how to enable LLDP on a device; disable LLDP on some interfaces; configure optional parameters such as hold time, delay time, and update frequency; and disable several LLDP TLVs:

```
switch# configure terminal
Enter configuration commands, one per line. End with CNTL/Z.
switch(config)# feature lldp
switch(config)# interface ethernet 7/9
switch(config-if)# no lldp transmit
switch(config-if)# no lldp receive
switch(config-if)# exit
switch(config)# interface ethernet 7/10
switch(config-if)# no lldp transmit
switch(config-if)# no lldp receive
switch(config-if)# exit
switch(config)# lldp holdtime 200
switch(config)# lldp reinit 5
switch(config)# lldp timer 50
switch(config)# no lldp tlv-select port-vlan
switch(config)# no lldp tlv-select system-name
```

17.9 Related Documents

Related Topic	Related Topic
LLDP commands: complete command syntax, command modes, command history, defaults, usage guidelines, and examples	<i>Inspur CN12700 Series INOS System Management Command Reference</i>
VDCs	<i>Inspur CN3000 Series Fabric Extender Software Configuration Guide</i>
Fabric Extender	<i>Inspur Network Analysis Module (NAM) for CN12700 Quick Start Guide</i>

17.10 Feature History for LLDP

The table below summarizes the new and changed features for this document and shows the releases in which each feature is supported. Your software release might not support all the features in this document. For the latest caveats and feature information, the release notes for your software release.

Table 32 Feature History for LLDP

Feature Name	Releases	Feature Information
LLDP	5.2(1)	Added LLDP support for the Inspur CN3000 Series Fabric Extender.
DCBXP	5.1(1)	This feature was introduced.
LLDP	5.0(2)	This feature was introduced.

CHAPTER 18 Configuring NetFlow

This chapter describes how to configure the NetFlow feature on Inspur INOS devices.

- Finding Feature Information
- NetFlow
- Licensing Requirements for NetFlow
- Prerequisites for NetFlow
- Guidelines and Limitations for NetFlow
- Default Settings for NetFlow
- Configuring NetFlow
- Verifying the NetFlow Configuration
- Monitoring NetFlow
- Configuration Examples for NetFlow
- Verification Examples for NetFlow CoPP Interface Support
- Related Documents
- Feature History for NetFlow

18.1 Finding Feature Information

Your software release might not support all the features documented in this module. For the latest caveats and feature information, the release notes for your software release. To find information about the features documented in this module, and to see a list of the releases in which each feature is supported, see the “New and Changed Information” chapter or the Feature History table.

18.2 NetFlow

NetFlow identifies packet flows for both ingress and egress IP packets and provide statistics based on these packet flows. NetFlow does not require any change to either the packets themselves or to any networking device.

18.2.1 Netflow Overview

NetFlow uses flows to provide statistics for accounting, network monitoring, and network planning. A flow is a unidirectional stream of packets that arrives on a source interface (or VLAN) and has the same values for the keys. A key is an identified value for a field within the packet. You create a flow using a flow record to define the unique keys for your flow.

Inspur INOS supports the Flexible NetFlow feature that enables enhanced network anomalies and security detection. Flexible NetFlow allows you to define an optimal flow record for a particular application by selecting the keys from a large collection of predefined fields.

All key values must match for the packet to count in a given flow. A flow might gather other fields of interest, depending on the export record version that you configure. Flows are stored in the NetFlow cache.

You can export the data that NetFlow gathers for your flow by using a flow exporter and export this data to a remote NetFlow collector. Inspur INOS exports a flow as part of a NetFlow export User Datagram Protocol (UDP) datagram under the following circumstances:

- The flow has been inactive or active for too long.
- The flow cache is getting full.
- One of the counters (packets or bytes) has exceeded its maximum value.

- You have forced the flow to export.

The flow record determines the size of the data to be collected for a flow. The flow monitor combines the flow record and flow exporter with the NetFlow cache information.

Inspur INOS can gather NetFlow statistics in either full or sampled mode. Inspur INOS analyzes all packets on the interface or subinterface for full NetFlow mode. For sampled mode, you configure the rate at which Inspur INOS analyzes packets.

18.2.2 Flow Records

A flow record defines the keys that NetFlow uses to identify packets in the flow as well as other fields of interest that NetFlow gathers for the flow. You can define a flow record with any combination of keys and fields of interest. Inspur INOS supports a rich set of keys. A flow record also defines the types of counters gathered per flow. You can configure 32-bit or 64-bit packet or byte counters.

The key fields are specified with the match keyword. The fields of interest and counters are specified under the collect keyword.

Inspur INOS enables the following match fields as the defaults when you create a flow record:

- match interface input
- match interface output
- match flow direction

18.2.3 Flow Exporters

A flow exporter contains network layer and transport layer details for the NetFlow export packet. You can configure the following information in a flow exporter:

- Export destination IP address
- Source interface
- UDP port number (where the collector is listening for NetFlow packets)

Inspur INOS exports data to the collector whenever a timeout occurs or when the flow is terminated (TCP FIN or RST received, for example). You can configure the following timers to force a flow export:

- Active timeout—Removes the cache entries from the cache. Prevents long-lasting flows from becoming invisible to the collector for a long period of time. The value of the active timeout should always be greater than that of the inactive timeout. Active timeout is supported on the M1, M2, F3 and M3 Series modules.
- Inactive timeout—Removes the cache entries from the cache. Inactive timeout is supported on the M1, M2, F3 and M3 Series modules.
- Fast timeout—Flushes low-hitting flows for the M1 and M2 Series modules.
- Aggressive timeout—Aggressively times out the flows when the cache starts getting full for the M1 and M2 Series modules.
- Flush cache timeout—Flushes the cache for F3 Series modules.

The active and inactive timeouts exist by default and cannot be unconfigured. Only their time values can be configured.

18.2.4 Export Formats

Inspur INOS supports the Version 5 and Version 9 export formats. We recommend that you use the Version 9 export format for the following reasons:

- More efficient network utilization
- Support for IPv6 and Layer 2 fields

If you configure the Version 5 export format, you have these limitations:

- Fixed field specifications
- No support for IPv6 and Layer 2 fields
- The `Netflow.InputInterface` and `Netflow.OutputInterface` represent a 16-bit I/O descriptor (IOD) of the interface.

18.2.5 Flow Monitors

A flow monitor references the flow record and flow exporter. You apply a flow monitor to an interface.

18.2.6 Samplers

Inspur INOS supports sampled NetFlow. This feature samples incoming and outgoing packets on an interface. The packets sampled then qualify to create flows.

Sampled NetFlow reduces the amount of export data sent to the collector by limiting the number of packets that create flows and the number of flows. It is essential when flows are created on a line card or external device, instead of on the forwarding engine. F2, F2e, F3, and M3 Series modules support only sampled NetFlow.

Implementing NetFlow on F2 and F2e Series modules creates flows in the software. Too many packets trying to create or update flows can increase the load on the CPU, thereby increasing the need for a protective rate limiter. The rate limiter limits the number of packets that reach the CPU to approximately 1000 packets per second. F3 and M3 Series modules use a special hardware called FSA, which is used as a NetFlow processor, to create flows.

The sampling mode supported on F2, F2e, F3, M3, M1, and M2 modules is M out of N, where M packets are selected randomly out of every N packets for sampling, and only those packets can create flows.

Rate limiter limits the number of packets that reach the CPU to approximately 1000 packets per second on the F2 and F2e Series modules. On the F3 Series module, rate limiting of 500 PPS per ASIC (SoC) is implemented. Hence, for Inspur INOS 12700, if the F3 Series module has 6 SoCs, then it will rate limit $500 * 6 = 3000$ PPS to the CPU, per F3 Series module; and for Inspur CN12700, if the F3 Series module has 12 SoCs, then it will rate limit $500 * 12 = 6000$ PPS to the CPU, per F3 Series module.

The F3 Series module supports more sampling rate, 1:131071 compared to 1:8191 on other F2 and F2e series modules.

On M3 series modules, the default rate limit value is 8000 PPS per ASIC (SoC). Use the hardware rate-limiter layer-2 netflow rate module `m3module` command on a specific M3 Series module to configure the rate limit value to 24000 PPS. This configuration will enable the M3 series module to rate limit $24000 * 2 = 48000$ PPS to the CPU per M3 Series module.

Use the hardware rate-limiter layer-2 netflow rate module `m3module` command on a specific M3 Series module to configure the rate limit value to 12000 PPS. This configuration will enable the M3 Series module to rate limit $12000 * 4 = 48000$ PPS to the CPU per M3 Series module.

18.2.7 Netflow on CoPP Interface Support

Netflow on CoPP Interface Support features enables application of Netflow on packets that are destined to the supervisor module, which is the control plane.

Netflow on CoPP Interface Support feature enables the monitoring of packets that are egressing to the control plane. This monitoring feature was added in INOS release 7.3(0)D1(1).

For more information on Control Plane Policing, See the *Inspur CN12700 Series INOS Security Configuration Guide*.

18.2.8 Network Analysis Module

You can also use the Inspur Network Analysis Module (NAM) to monitor NetFlow data sources. NAM enables traffic analysis views and reports such as hosts, applications, conversations, VLAN, and QoS. See the NAM configuration example in the Configuration Examples for NetFlow.

To use NAM for monitoring the Inspur CN12700 NetFlow data sources, see the *Inspur CN12700 Series Network Analysis Module (NAM-NX1) Quick Start Guide*.

18.2.9 High Availability

Inspur INOS supports stateful restarts for NetFlow. After a reboot or supervisor switchover, Inspur INOS applies the running configuration.

Because the flow cache is not preserved across restarts of the process and packets that come to the software during restarts cannot be processed, all of the flows during switchovers are lost and cannot be recovered.

18.2.10 Virtualization Support

A virtual device context (VDC) is a logical representation of a set of system resources. Within each VDC, you can configure NetFlow. By default, Inspur INOS places you in the default VDC and any flows that you define in this mode are only available for interfaces in the default VDC.

For information about configuring VDCs, see the *Inspur CN12700 Series INOS Virtual Device Context Configuration Guide*.

18.3 Licensing Requirements for NetFlow

Table 33 NetFlow Licensing Requirements

Product	License Requirement
Inspur INOS	NetFlow requires no license. Any feature not included in a license package is bundled with the Inspur INOS system images and is provided at no extra charge to you. For a complete explanation of the Inspur INOS licensing scheme, see the Inspur INOS Licensing Guide.

18.4 Prerequisites for NetFlow

NetFlow has the following prerequisites:

- You must understand the resources required on your device because NetFlow consumes additional memory and CPU resources.
- If you configure VDCs, install the appropriate license and enter the desired VDC. See the Inspur CN12700 Series INOS Virtual Device Context Configuration Guide for configuration information and the Inspur INOS Licensing Guide for licensing information.

18.5 Guidelines and Limitations for NetFlow

NetFlow has the following configuration guidelines and limitations:

- You must configure a source interface for the NDE export. If you do not configure a source interface, the flow exporter will remain in a disabled state.
- You must configure a valid record name for every flow monitor.
- All of the NetFlow timeouts, except the flow timeout, The flow timeout is supported only for F3 Series modules. Only active and inactive timeouts are applicable for M3 Series modules.
- A rollback will fail if you try to modify a record that is programmed in the hardware during a rollback.
- Only Layer 2 NetFlow is applied on Layer 2 interfaces, and only Layer 3 NetFlow is applied on Layer 3 interfaces.
- If you add a member to a port channel that is already configured for Layer 2 NetFlow, its NetFlow

configuration is removed and the Layer 2 configuration of the port channel is added to it.

- If you change a Layer 2 interface to a Layer 3 interface, the software removes the Layer 2 NetFlow configuration from the interface.
 - Use NetFlow v9 export to see the full 32-bit SNMP ifIndex values at the NetFlow connector.
 - The maximum number of supported NetFlow entries is 512,000.
 - On tunnel interface, NetFlow is not supported, even though its configurable.
 - The Inspur CN3000 Series Fabric Extender (FEX) supports a Layer 3 NetFlow configuration on FEX ports.
 - The Inspur CN3000 Series FEX supports bridged NetFlow (for flows within a VLAN).
 - F3 Series modules do not support the following changes:
 - Changing the fields in a record that is applied on the active monitor.
 - Changing the sampling mode value on a sampler that is applied on the active monitor.
- Beginning with Inspur INOS Release 5.2, NetFlow is supported on switch virtual interfaces (SVIs) for F1 Series ports, if at least one M1 Series module is present. SVI NetFlow is for traffic that is routed between VLANs.
 - For M Series modules, if you apply a Layer 3 NetFlow input flow monitor to an SVI and apply a Layer 2 NetFlow input flow monitor to a Layer 2 interface such as a trunk that allows the same underlying VLAN, all input flows into both interfaces are reported by the Layer 2 NetFlow flow monitor only.
 - F2, F2e, F3, and M3 Series modules support only sampled NetFlow.
 - Beginning with Inspur INOS Release 6.2(6), sampled NetFlow is supported on F3 Series modules.
 - Egress NetFlow is not supported on F2, F2e modules, and on any mixed VDC the modules are present in.
 - Beginning from Inspur INOS Release 7.2(0)D1(1), Egress NetFlow is supported on F3 modules.
 - Beginning from Inspur INOS Release 7.2(1)D1(1), Sub-interfaces are supported on F3 series modules.
 - By default, you cannot use ingress NetFlow sampling and DHCP relay together on the same interface. However, beginning with Inspur INOS Release 6.2(2), you can override the default and configure these two features on the same interface using the **hardware access-list resource feature bank-mapping command**, after you have entered the necessary commands to enable each of these features individually. For more information on this command, see the **Configuring IP ACLs** chapter of the *Inspur CN12700 Series INOS Security Configuration Guide*.
 - Beginning with Inspur INOS Release 6.2(2), full NetFlow is supported on the Inspur NetFlow Generation Appliance (NGA) through SPAN. Sampled NetFlow is supported on the NGA through sampled SPAN.

NetFlow has the following limitations for mixed VDCs with both M1, M2 Series and F2, F2e, F3, and M3 Series modules:

- A VDC is classified as a mixed VDC only when it contains at least one F2e Series port or at least one F3 Series port.
 - Layer 2 NetFlow—Sampled and full NetFlow is supported on the M1 and M2 Series module ports, and only sampled NetFlow is supported on the F3 Series module ports.
 - Layer 3 NetFlow—Sampled and full NetFlow is supported on the M1 and M2 Series module ports. The F2 and F2e Series module ports come up in proxy mode and, therefore, cannot be configured as Layer 3 ports. Thus, Layer 3 NetFlow and subinterface NetFlow do not work with these ports. Sampled NetFlow is supported on F3 and M3 Series module ports.
 - VLANs, SVIs, and port channels—Only sampled NetFlow is supported on VLANs, SVIs, and port channels for both the M1 and M2 Series and F2e, F3, and M3 Series modules.
 - Subinterfaces (physical/port channels)—NetFlow configuration is supported on the F2, F2e, F3, and M3 Series module interfaces.
- Dynamic configuration change is not available in the mixed VDC for the policies applied on the F3 Series modules.
 - Flow timeout applies only to the F3 Series modules.
 - Egress NetFlow is completely blocked in VDCs that contain both F3 Series modules.

Guidelines and Limitations Specific to NetFlow on CoPP Interface Support feature:

- The feature can be configured only on the default VDC.

- Only unicast packets are supported.
- The feature supports capture of Layer 3 NetFlow fields only. Capture of Layer 2 fields are not supported.
- The feature requires mandatory configuration of a sampler.
- After the feature is enabled, it is applied on all the line cards in the system as follows:
- F3 line cards create flows in the software. The limits on the size of PPS per table is shared with the regular NetFlow.
 - The feature can be applied only in the egress direction, because the packets egress to the supervisor module.

18.6 Default Settings for NetFlow

The following table lists the default settings for NetFlow parameters.

Table 34 Default NetFlow Parameters

Parameters	Default
Egress and ingress cache size	512,000
Flow active timeout	1800 seconds
Flow timeout (for F3 Series modules only)	15 seconds
Flow timeout aggressive threshold	Disabled
Flow timeout fast threshold	Disabled
Flow timeout inactive	15 seconds
Flow timeout session aging	Disabled

18.7 Configuring NetFlow

To configure NetFlow, follow these steps:

Procedure

-
- Step 1** Enable the NetFlow feature.
 - Step 2** Define a flow record by specifying keys and fields to the flow.
 - Step 3** Define an optional flow exporter by specifying the export format, protocol, destination, and other parameters.
 - Step 4** Define a flow monitor based on the flow record and flow exporter.
 - Step 5** Apply the flow monitor to a source interface, subinterface, VLAN interface.
-

18.7.1 Enabling the NetFlow Feature

You must globally enable NetFlow before you can configure any flows. Use the following command in global configuration mode to enable NetFlow:

Command	Purpose
feature netflow	Enables the NetFlow feature.
Example: switch(config)# feature netflow	
no feature netflow	Disables the NetFlow feature. The default is disabled.

Example:	
switch(config)# no feature netflow	

18.7.2 Creating a Flow Record

You can create a flow record and add keys to match on and nonkey fields to collect in the flow.

Before you begin

Make sure that you are in the correct VDC. To change the VDC, use the `switchto vdc` command.

Procedure

	Command or Action	Purpose
Step 1	configure t Example: switch# config t Enter configuration commands, one per line. End with CNTL/Z. switch(config)#	Enters global configuration mode.
Step 2	flow record <i>name</i> Example: switch(config)# flow record Test switch(config-flow-record)#	Creates a flow record and enters flow record configuration mode. You can enter up to 63 alphanumeric characters for the flow record name.
Step 3	(Optional) description <i>string</i> Example: switch(config-flow-record)# description Ipv4Flow	(Optional) Describes this flow record as a maximum 63-character string.
Step 4	(Optional) match <i>type</i> Example: switch(config-flow-record)# match transport destination-port	Specifies a match key. Note The match transport destination-port and the match ip protocol commands are required to export Layer 4 port data.
Step 5	collect <i>type</i> Example: switch(config-flow-record)# collect counter packets	(Optional) Specifies the collection field.
Step 6	show flow record [<i>name</i>] [<i>record-name</i>] netflow-original netflow protocol-port netflow { <i>ipv4</i> <i>ipv6</i> } { original-input original-output }} Example: switch(config-flow-exporter)# show flow record netflow protocol-port	(Optional) Displays information about NetFlow flow records. You can enter up to 63 alphanumeric characters for the flow record name.
Step 7	copy running-config startup-config Example: switch(config-flow-exporter)# copy running-config startup-config	(Optional) Saves this configuration change.

18.7.2.1 Specifying the Match Parameters

You must configure at least one of the following match parameters for flow records:

Command	Purpose
match ip {protocol tos} Example: switch(config-flow-record)# match ip protocol	Specifies the IP protocol or ToS fields as keys Note The match transport destination-port and the match ip protocol commands are required to export Layer 4 port data. The data is collected and displayed in the output of the show hardware flow ip command but is not collected and exported until you configure both commands.
match ipv4 {destination address source address} Example: switch(config-flow-record)# match ipv4 destination address	Specifies the IPv4 source or destination address as a key.
match ipv6 {destination address source address flow-label options } Example: switch(config-flow-record)# match ipv6 flow label	Specifies the IPv6 key.
match transport {destination-port source-port} Example: switch(config-flow-record)# match transport destination-port	Specifies the transport source or destination port as a key. Note The match transport destination-port and the match ip protocol commands are required to export Layer 4 port data. The data is collected and displayed in the output of the show hardware flow ip command but is not collected and exported until you configure both commands.
match datalink {mac source-address mac destination-address ethernet vlan} Example: switch(config-flow-record)# match datalink ethernet	Specifies the Layer 2 attribute as a key.

18.7.2.2 Specifying the Collect Parameters

You must configure at least one of the following collect parameters for flow records:

Command	Purpose
collect counter {bytes packets} [long] Example: switch(config-flow-record)# switch(config-flow-record)# collect counter packets	Collects either packet-based or byte counters from the flow. You can optionally specify that 64-bit counters are used.
collect flow sampler id Example: switch(config-flow-record)# collect flow sampler	Collects the sampler identifier used for the flow.
collect timestamp sys-uptime {first last} Example: switch(config-flow-record)# collect timestamp sys-uptime last	Collects the system up time for the first or last packet in the flow.
collect transport tcp flags Example: switch(config-flow-record)# collect transport tcp flags	Collects the TCP transport layer flags for the packets in the flow.

collect ip version Example: switch(config-flow-record)# collect ip version	Collects the IP version for the flow.
--	---------------------------------------

18.7.3 Creating a Flow Exporter

The flow exporter configuration defines the export parameters for a flow and specifies reachability information for remote NetFlow collector.

Procedure

	Command or Action	Purpose
Step 1	configure terminal Example: switch# configure terminal switch(config)#	Enters global configuration mode.
Step 2	flow exporter <i>name</i> Example: switch(config)# flow exporter flow-exporter-one	Creates a flow exporter and enters flow exporter configuration mode. You can enter up to 63 alphanumeric characters for the flow exporter name.
Step 3	destination { ipv4-address ipv6-address } [use-vrf <i>name</i>] Example: switch(config-flow-exporter)# destination 192.0.2.1	Sets the destination IPv4 or IPv6 address for this flow exporter. You can optionally configure the VRF to use to reach the NetFlow collector. You can enter up to 32 alphanumeric characters for the VRF name.
Step 4	source interface-type <i>name/port</i> Example: switch(config-flow-exporter)# source ethernet 2/1	Specifies the interface to use to reach the NetFlow collector at the configured destination.
Step 5	(Optional) description <i>string</i> Example: switch(config-flow-exporter)# description exportversion9	(Optional) Describes this flow exporter. You can enter up to 63 alphanumeric characters for the description.
Step 6	(Optional) dscp <i>value</i> Example: switch(config-flow-exporter)# dscp 0	(Optional) Specifies the differentiated services codepoint value. The range is from 0 to 63.
Step 7	(Optional) transport udp <i>port</i> Example: switch(config-flow-exporter)# transport udp 200	(Optional) Specifies the UDP port to use to reach the NetFlow collector. The range is from 0 to 65535. Note If you do not specify the UDP port, 9995 is selected as the default.
Step 8	version { 5 9 } Example: switch(config-flow-exporter)# version 9	Specifies the NetFlow export version. Choose version 9 to enter the flow exporter version 9 configuration submode.
Step 9	(Optional) option { exporter-stats interface-table sampler-table } timeout <i>seconds</i> Example: switch(config-flow-exporter-version-9)# option exporter-stats timeout 1200	Sets the flow exporter statistics resend timer. The range is from 1 to 86400 seconds.
Step 10	(Optional) template data timeout <i>seconds</i> Example:	Sets the template data resend timer. The range is from 1 to 86400 seconds.

	Command or Action	Purpose
	switch(config-flow-exporter-version-9)# template data timeout 1200	
Step 11	exit Example: switch(config-flow-exporter-version-9)# exit	Returns to flow exporter configuration mode.
Step 12	exit Example: switch(config-flow-exporter)# exit	Returns to global configuration mode.
Step 13	(Optional) copy running-config startup-config Example: switch(config)# copy running-config startup-config	Saves the change persistently through reboots and restarts by copying the running configuration to the startup configuration.

18.7.4 Creating a Flow Monitor

You can create a flow monitor and associate it with a flow record and a flow exporter. All the flows that belong to a monitor use the associated flow record to match on the different fields and the data is exported to the specified flow exporter.

Procedure

	Command or Action	Purpose
Step 1	configure terminal Example: switch# configure terminal switch(config)#	Enters global configuration mode.
Step 2	flow monitor <i>name</i> Example: switch(config)# flow monitor flow-monitor-one	Creates a flow monitor and enters flow monitor configuration mode. You can enter up to 63 alphanumeric characters for the flow monitor name.
Step 3	(Optional) description <i>string</i> Example: switch(config-flow-monitor)# description IPv4Monitor	Describes this flow monitor. You can enter up to 63 alphanumeric characters for the description.
Step 4	(Optional) exporter <i>name</i> Example: switch(config-flow-monitor)# export v9	Associates a flow exporter with this flow monitor. You can enter up to 63 alphanumeric characters for the exporter name.
Step 5	record { <i>name</i> netflow-original netflow protocol-port netflow {ipv4 ipv6} {original-input original-output} } Example: switch(config-flow-monitor)# record IPv4Flow	Associates a flow record with the specified flow monitor. You can enter up to 63 alphanumeric characters for the record name.
Step 6	exit Example: switch(config-flow-monitor)# exit	Returns to global configuration mode.
Step 7	(Optional) copy running-config startup-config Example: switch(config)# copy running-config startup-config	Saves the change persistently through reboots and restarts by copying the running configuration to the startup configuration.

18.7.5 Creating a Sampler

You can create a flow sampler to define the NetFlow sampling rate for a flow.

Procedure

	Command or Action	Purpose
Step 1	configure terminal Example: switch# configure terminal switch(config)#	Enters global configuration mode.
Step 2	sampler name Example: switch(config)# sampler testsampler	Creates a sampler and enters flow sampler configuration mode. You can enter up to 63 alphanumeric characters for the flow sampler name.
Step 3	(Optional) description string Example: switch(config-flow-sampler)# description samples	(Optional) Describes this sampler. You can enter up to 63 alphanumeric characters for the description.
Step 4	mode sample-number out-of packet-number Example: switch(config-flow-sampler)# mode 1 out-of 128	Defines the number of samples to take per the number of packets received. The sample-number range is from 1 to 64, and the packet-number range is from 1 to 65536 packets.
Step 5	exit Example: switch(config-flow-sampler)# exit	Returns to global configuration mode.
Step 6	(Optional) copy running-config startup-config Example: switch(config)# copy running-config startup-config	Saves the change persistently through reboots and restarts by copying the running configuration to the startup configuration.

18.7.6 Applying a Flow Monitor to an Interface

Procedure

	Command or Action	Purpose
Step 1	configure terminal Example: switch# configure terminal switch(config)#	Enters global configuration mode.
Step 2	interface interface-type slot/port Example: switch(config)# interface ethernet 2/1	Enters interface configuration mode. The interface type can be Ethernet (including subinterfaces), port channel, or VLAN interface.
Step 3	ip flow monitor name input sampler name Example: switch(config-if)# ip flow monitor testmonitor input sampler testsampler	Associates an IPv4 flow monitor and a sampler to the interface for input packets. You can enter up to 63 alphanumeric characters for the flow monitor name and the sampler name.
Step 4	ipv6 flow monitor name input sampler name Example: switch(config-if)# ipv6 flow monitor	Associates an IPv6 flow monitor and a sampler to the interface for input packets. You can enter up to 63 alphanumeric characters for the flow

	Command or Action	Purpose
	testmonitorv6 input sampler testsamplerv6	monitor name and the sampler name.
Step 5	layer2-switched flow monitor <i>name</i> input sampler <i>name</i> Example: switch(config-if)# layer2-switched flow monitor testmonitorl2 input sampler testsamplerl2	Associates a Layer 2-switched flow monitor and a sampler to the interface for input packets. You can enter up to 63 alphanumeric characters for the flow monitor name and the sampler name.
Step 6	exit Example: switch(config-if)# exit	Returns to global configuration mode.
Step 7	(Optional) copy running-config startup-config Example: switch(config)# copy running-config startup-config	Saves the change persistently through reboots and restarts by copying the running configuration to the startup configuration.

18.7.7 Configuring Netflow on CoPP Interface Support

You can create a flow record and add keys to match on and nonkey fields to collect in the flow.

Before you begin

Perform the following configuration on the default VDC.

Procedure

-
- Step 1** Enter global configuration mode:
- ```
switch# configure terminal
```
- Step 2** Enter control-plane configuration mode. Enable users to associate attributes that are associated with the control plane of the device:
- ```
switch(config)# control-plane
```
- Step 3** Associate an IPv4 flow monitor and a sampler to the control-plane for output packets. You can enter up to 63 alphanumeric characters for the flow monitor name and the sampler name:
- ```
switch(config-cp)# ip flow monitor name output sampler name
```
- 

#### What to do next

You must perform the following tasks to complete configuring Netflow on COPP Interface Support feature:

- Creating a Flow Record
- Creating a Flow Monitor
- Creating a Sampler

### 18.7.8 Configuring Bridged NetFlow on a VLAN

You can apply a flow monitor and a sampler to a VLAN.

#### Procedure

|  | Command or Action | Purpose |
|--|-------------------|---------|
|--|-------------------|---------|

|        | Command or Action                                                                                                                                                           | Purpose                                                                                                                                                                                                                                           |
|--------|-----------------------------------------------------------------------------------------------------------------------------------------------------------------------------|---------------------------------------------------------------------------------------------------------------------------------------------------------------------------------------------------------------------------------------------------|
| Step 1 | <b>configure terminal</b><br><b>Example:</b><br>switch# configure terminal<br>switch(config)#                                                                               | Enters global configuration mode.                                                                                                                                                                                                                 |
| Step 2 | <b>vlan configuration <i>vlan-id</i></b><br><b>Example:</b><br>switch(config)# vlan configuration 30                                                                        | Enters VLAN configuration mode. The <i>vlan-id</i> range is from 1 to 3967 or from 4048 to 4093.<br><b>Note</b> VLAN configuration mode enables you to configure VLANs independently of their creation, which is required for VTP client support. |
| Step 3 | <b>{ip ipv6} flow monitor <i>name</i> input sampler <i>name</i></b><br><b>Example:</b><br>switch(config-vlan-config)# ip flow monitor testmonitor input sampler testsampler | Associates a flow monitor and a sampler to the VLAN for input packets. You can enter up to 63 alphanumeric characters for the flow monitor name and the sampler name.                                                                             |
| Step 4 | <b>exit</b><br><b>Example:</b><br>switch(config-vlan-config)# exit                                                                                                          | Returns to global configuration mode.                                                                                                                                                                                                             |
| Step 5 | (Optional) <b>copy running-config startup-config</b><br><b>Example:</b><br>switch(config)# copy running-config startup-config                                               | Saves the change persistently through reboots and restarts by copying the running configuration to the startup configuration.                                                                                                                     |

### 18.7.9 Configuring Layer 2 NetFlow

You can define Layer 2 keys in flexible NetFlow records that you can use to capture flows in Layer 2 interfaces. The Layer 2 keys are as follows:

- Source and destination MAC addresses
- Source VLAN ID
- EtherType from the Ethernet frame

You can apply Layer 2 NetFlow to the following interfaces for the ingress direction:

- Switch ports in access mode
- Switch ports in trunk mode
- Layer 2 port channels

#### Before you begin

Make sure that you are in the correct VDC. To change the VDC, use the `switchto vdc` command.

#### Procedure

|        | Command or Action                                                                                                                   | Purpose                                |
|--------|-------------------------------------------------------------------------------------------------------------------------------------|----------------------------------------|
| Step 1 | <b>configure t</b><br><b>Example:</b><br>switch# configure terminal<br>Enter configuration commands, one per line. End with CNTL/Z. | Enters global configuration mode.      |
| Step 2 | Required: <b>flow record <i>name</i></b><br><b>Example:</b>                                                                         | Enters flow record configuration mode. |

|               | Command or Action                                                                                                                                                                                          | Purpose                                                                                                                                                                                                                                     |
|---------------|------------------------------------------------------------------------------------------------------------------------------------------------------------------------------------------------------------|---------------------------------------------------------------------------------------------------------------------------------------------------------------------------------------------------------------------------------------------|
|               | switch(config)# flow record L2_record                                                                                                                                                                      |                                                                                                                                                                                                                                             |
| <b>Step 3</b> | Required: <b>match datalink</b> { <b>mac source-address</b>   <b>mac destination-address</b>   <b>ethertype</b>   <b>vlan</b> }<br><b>Example:</b><br>switch(config-flow-record)# match datalink ethertype | Specifies the Layer 2 attribute as a key.                                                                                                                                                                                                   |
| <b>Step 4</b> | Required: <b>interface</b> { <b>ethernet slotport</b> }   { <b>port-channel number</b> }<br><b>Example:</b><br>switch(config-flow-record)# interface Ethernet 6/3                                          | Enters interface configuration mode. The interface type can be a physical Ethernet port or a port channel.                                                                                                                                  |
| <b>Step 5</b> | Required: <b>switchport</b><br><b>Example:</b><br>switch(config-if)# switchport                                                                                                                            | Changes the interface to a Layer 2 physical interface. For information about configuring switch ports, see the <i>Inspur CN12700 Series INOS Layer 2 Switching Configuration Guide</i> .                                                    |
| <b>Step 6</b> | Required: <b>mac packet-classify</b><br><b>Example:</b><br>switch(config-if)# mac packet-classify                                                                                                          | Forces MAC classification of packets. For more information about using the mac packet-classify command, see the <i>Inspur CN12700 Series INOS Security Configuration Guide</i> .<br><b>Note</b> You must use this command to capture flows. |
| <b>Step 7</b> | Required: <b>layer2-switched flow monitor flow-name input [sampler sampler-name]</b><br><b>Example:</b><br>switch(config-vlan)# layer2-switched flow monitor L2_monitor input sampler L2_sampler           | Associates a flow monitor and an optional sampler to the switch port input packets. <ul style="list-style-type: none"> <li>You can enter up to 63 alphanumeric characters for the flow monitor name and the sampler name.</li> </ul>        |
| <b>Step 8</b> | Required: <b>show flow record netflow layer2-switched input</b><br><b>Example:</b><br>switch(config-if)# show flow record netflow layer2-switched input                                                    | (Optional) Displays information about the Layer 2 NetFlow default record.                                                                                                                                                                   |
| <b>Step 9</b> | Required: <b>copy running-config startup-config</b><br><b>Example:</b><br>switch(config-vlan)# copy running-config startup-config                                                                          | (Optional) Saves this configuration change.                                                                                                                                                                                                 |

### 18.7.10 Configuring NetFlow Timeouts

You can optionally configure global NetFlow timeouts that apply to all flows in the system.

#### Procedure

|               | Command or Action                                                          | Purpose                           |
|---------------|----------------------------------------------------------------------------|-----------------------------------|
| <b>Step 1</b> | <b>configure terminal</b><br><b>Example:</b><br>switch# configure terminal | Enters global configuration mode. |

|               | Command or Action                                                                                                             | Purpose                                                                                                                       |
|---------------|-------------------------------------------------------------------------------------------------------------------------------|-------------------------------------------------------------------------------------------------------------------------------|
|               | switch(config)#                                                                                                               |                                                                                                                               |
| <b>Step 2</b> | <b>flow timeout</b> <i>seconds</i><br><b>Example:</b><br>switch(config)# flow timeout 30                                      | Sets the flush timeout value in seconds. The range is from 5 to 60 seconds.                                                   |
| <b>Step 3</b> | (Optional) <b>copy running-config startup-config</b><br><b>Example:</b><br>switch(config)# copy running-config startup-config | Saves the change persistently through reboots and restarts by copying the running configuration to the startup configuration. |

## 18.8 Verifying the NetFlow Configuration

To display the NetFlow configuration, perform one of the following tasks:

| Command                                                        | Purpose                                                                                                                                      |
|----------------------------------------------------------------|----------------------------------------------------------------------------------------------------------------------------------------------|
| <b>show flow exporter</b> [ <i>name</i> ]                      | Displays information about NetFlow flow exporters and statistics. You can enter up to 63 alphanumeric characters for the flow exporter name. |
| <b>show flow interface</b> [ <i>interface-type slot/port</i> ] | Displays information about NetFlow interfaces.                                                                                               |
| <b>show flow record</b> [ <i>name</i> ]                        | Displays information about NetFlow flow records. You can enter up to 63 alphanumeric characters for the flow record name.                    |
| <b>show flow record netflow layer2-switched input</b>          | Displays information about the Layer 2 NetFlow configuration.                                                                                |
| <b>show flow timeout</b>                                       | Displays information about NetFlow timeouts.                                                                                                 |
| <b>show sampler</b> [ <i>name</i> ]                            | Displays information about NetFlow samplers. You can enter up to 63 alphanumeric characters for the sampler name.                            |
| <b>show hardware ip flow</b>                                   | Displays information about NetFlow hardware IP flows.                                                                                        |
| <b>show running-config netflow</b>                             | Displays the NetFlow configuration that is currently on your device.                                                                         |

## 18.9 Monitoring NetFlow

Use the show flow exporter command to display NetFlow statistics. Use the clear flow exporter command to clear NetFlow flow exporter statistics.

## 18.10 Configuration Examples for NetFlow

This example shows how to configure a NetFlow exporter configuration for IPv4 :

```
feature netflow
flow exporter ee
version 9
flow record rr
match ipv4 source address
match ipv4 destination address
collect counter bytes
collect counter packets
flow monitor foo
record rr
exporter ee
interface Ethernet2/45
```



```

ip flow monitor foo input
ip address 10.20.1.1/24
no shutdown

```

This example shows a NetFlow exporter configuration for IPv4 from the Inspur CN12700 Series switch to NAM:

```

flow exporter pw
 destination 172.20.101.87 use-vrf management
 transport udp 3000
 source mgmt0
 version 9

flow record pw
 match ipv4 source address
 match ipv4 destination address
 match ip protocol
 match ip tos
 match transport source-port
 match transport destination-port
 collect counter bytes long
 collect counter packets long
 collect timestamp sys-uptime first
 collect timestamp sys-uptime last
 collect ip version

flow monitor pw
 record pw
 exporter pw

interface Ethernet2/9
 ip flow monitor pw input
 ip flow monitor pw output

```

## 18.11 Verification Examples for NetFlow CoPP Interface Support

### Sample Output for the show hardware flow ip Command

```

switch(config-if)# show hardware flow ip

D - Direction; L4 Info - Protocol:Source Port:Destination Port
IF - Interface: (Eth)ernet, (S)vi, (V)lan, (P)ortchannel, (T)unnel
TCP Flags: Ack, Flush, Push, Reset, Syn, Urgent

D IF SrcAddr DstAddr L4 Info PktCnt TCP Fl
--+-----+-----+-----+-----+-----+-----
CP sup-eth1 010.014.014.002 010.014.014.001 001:00000:00000 0000000021

```

### Sample Output for the show running-configuration netflow Command

```

switch# show running-configuration netflow

version 7.3(0)D1(1)

feature netflow

flow timeout active 60
flow exporter expl
 destination 10.76.80.132 use-vrf management
 transport udp 9995
 source mgmt0 version 9
 template data timeout 5 option
 sampler-table timeout 8

```

```
sampler s3
mode 2 out-of 3
flow monitor M2
record netflow ipv4 original-input
exporter expl
control-plane
ip flow monitor M2 output sampler s3
```

## 18.12 Related Documents

| Related Topic                             | Related Topic                                                                |
|-------------------------------------------|------------------------------------------------------------------------------|
| NetFlow CLI commands                      | <i>Inspur CN12700 Series INOS System Management Command Reference</i>        |
| VDCs and VRFs                             | <i>Inspur CN12700 Series INOS Virtual Device Context Configuration Guide</i> |
| Inspur Network Analysis Module (NAM)      | <i>Inspur Network Analysis Module (NAM) for CN12700 Quick Start Guide</i>    |
| Inspur NetFlow Generation Appliance (NGA) | <i>Inspur CN12700 Series INOS Virtual Device Context Configuration Guide</i> |

## 18.13 Feature History for NetFlow

The table below summarizes the new and changed features for this document and shows the releases in which each feature is supported. Your software release might not support all the features in this document. For the latest caveats and feature information, the release notes for your software release.

Table 35 Feature History for NetFlow

| Feature Name    | Releases    | Feature Information                                                                                                                                     |
|-----------------|-------------|---------------------------------------------------------------------------------------------------------------------------------------------------------|
| NetFlow         | 8.0(1)      | The first switched and the last switched sizes are changed to 8 bytes (from 4 bytes).                                                                   |
| NetFlow         | 7.3(2)D1(2) | The first switched and the last switched sizes are changed to 8 bytes (from 4 bytes).                                                                   |
| NetFlow         | 7.3(0)DX(1) | Added support for NetFlow on M3 Series modules.                                                                                                         |
| NetFlow         | 7.3(0)D1(1) | Added Netflow on CoPP Interface support.                                                                                                                |
| NetFlow         | 7.2(0)D1(1) | Enhanced the F3 Series module packet processing rate to 50000 pps.                                                                                      |
| NetFlow         | 6.2(6)      | Added support for F3 Series modules.                                                                                                                    |
| NetFlow         | 6.2(2)      | Added support for ingress NetFlow sampling and DHCPrelay to be configured on the same interface.                                                        |
| NetFlow         | 6.2(2)      | Added NAM support for NetFlow data sources.                                                                                                             |
| NetFlow         | 6.2(2)      | Added support for full NetFlow and sampled NetFlow on the Inspur NetFlow Generation Appliance (NGA).                                                    |
| NetFlow         | 6.1(2)      | Added support for sampled NetFlow on F2 Series and F2eSeries modules.                                                                                   |
| NetFlow         | 6.1(2)      | Added the flow timeout seconds command for F2 Series and F2e Series modules.                                                                            |
| NetFlow         | 6.0(1)      | NetFlow is not supported on F2 Series modules.                                                                                                          |
| NetFlow         | 6.0(1)      | Added support for the collect routing forwarding-status command to trigger the collection of flows denied by ACL entries.                               |
| NetFlow         | 5.2(1)      | NetFlow is supported on switch virtual interfaces (SVIs) for F1 Series ports.                                                                           |
| Bridged NetFlow | 5.1(1)      | VLAN configuration mode, which enables you to configure VLANs independently of their creation, is supported when configuring bridged NetFlow on a VLAN. |

---

| <b>Feature Name</b>     | <b>Releases</b> | <b>Feature Information</b>                                                                                           |
|-------------------------|-----------------|----------------------------------------------------------------------------------------------------------------------|
| NetFlow verification    | 5.0(2)          | You can specify the NetFlow instance for which you want to display NetFlow IPv4 flows and NetFlow table utilization. |
| Layer 2 NetFlow         | 4.2(1)          | You can define Layer 2 keys in flexible NetFlow records that you can use to capture flows in Layer 2 interfaces.     |
| Rollback during NetFlow | 4.1(3)          | Rollback fails for NetFlow if, during rollback, you try to modify a record that is programmed in the hardware.       |

## CHAPTER 19 Configuring EEE

---

This chapter describes how to configure Energy Efficient Ethernet (EEE) on Inspur INOS devices.

- Finding Feature Information
- Information About EEE
- Virtualization Support
- Licensing Requirements for EEE
- Prerequisites for EEE
- Guidelines and Limitations
- Default Settings
- Configuring EEE
- Verifying the EEE Configuration
- Configuration Examples for EEE
- Related Documents
- Feature History for EEE

### 19.1 Finding Feature Information

Your software release might not support all the features documented in this module. For the latest caveats and feature information, the release notes for your software release. To find information about the features documented in this module, and to see a list of the releases in which each feature is supported, see the “New and Changed Information” chapter or the Feature History table.

### 19.2 Information About EEE

#### 19.2.1 EEE

Energy Efficient Ethernet (EEE) is an IEEE 802.3az standard that is designed to reduce power consumption in Ethernet networks during idle periods. EEE can be enabled on devices that support low power idle (LPI) mode. Such devices can save power by entering LPI mode during periods of low utilization. In LPI mode, systems on both ends of the link can save power by shutting down certain services. EEE provides the protocol needed to transition into and out of LPI mode in a way that is transparent to upper layer protocols and applications.

#### 19.2.2 EEE LPI Sleep Threshold

The EEE LPI sleep threshold specifies how long an interface should wait to go to sleep after detecting an idle state. You can configure the threshold to be aggressive or nonaggressive.

#### 19.2.3 EEE Latency

The EEE latency specifies the EEE delay that is added to your traffic. The default value is a constant latency of 6 microseconds.

### 19.3 Virtualization Support

By default, Inspur INOS places you in the default virtual device context (VDC) unless you specifically configure another VDC. For more information about VDCs, see the *Inspur CN12700 Series INOS Virtual Device Context Configuration Guide*.

## 19.4 Licensing Requirements for EEE

| Product     | License Requirement                                                                                                                                                                                                                                                          |
|-------------|------------------------------------------------------------------------------------------------------------------------------------------------------------------------------------------------------------------------------------------------------------------------------|
| Inspur INOS | EEE requires no license. Any feature not included in a license package is bundled with the Inspur INOS system images and is provided at no extra charge to you. For a complete explanation of the Inspur INOS licensing scheme, see the <i>Inspur INOS Licensing Guide</i> . |

## 19.5 Prerequisites for EEE

EEE has the following prerequisites:

- To configure VDCs, you must install the appropriate license. See the Inspur CN12700 Series INOS Virtual Device Context Configuration Guide for configuration information and the Inspur INOS Licensing Guide for licensing information.

## 19.6 Guidelines and Limitations

Guidelines and Limitations:

- Only F2e (enhanced) copper port modules support EEE. F2e fiber port modules do not support EEE
- EEE is supported only for 10-Gigabit link speeds. It is not supported for 1-Gigabit link speeds.
- Changing the EEE configuration resets the interface because the device has to restart Layer 1 autonegotiation.
- You might want to enable the Link Layer Discovery Protocol (LLDP) for devices that require longer wakeup times before they are able to accept data on their receive paths. Doing so enables the device to negotiate for extended system wakeup times from the transmitting link partner.

## 19.7 Default Settings

Lists the default settings for EEE parameters.

Table 36 Default EEE Parameters

| Parameters              | Default        |
|-------------------------|----------------|
| EEE                     | Disabled       |
| EEE LPI sleep threshold | Nonaggressive  |
| EEE latency             | 6 microseconds |

## 19.8 Configuring EEE

This section includes the following topics:

- Enabling or Disabling EEE
- Configuring the EEE LPI Sleep Threshold

### 19.8.1 Enabling or Disabling EEE

You can enable or disable EEE on an interface that is connected to an EEE-capable link partner.

**Before you begin**

Make sure that you are in the correct VDC. To change the VDC, use the `switchto vdc` command.

**Procedure**

|               | <b>Command or Action</b>                                                     | <b>Purpose</b>                                                                                                                              |
|---------------|------------------------------------------------------------------------------|---------------------------------------------------------------------------------------------------------------------------------------------|
| <b>Step 1</b> | <code>switch# configure terminal</code>                                      | Places you in global configuration mode.                                                                                                    |
| <b>Step 2</b> | <code>switch(config)# interface ethernet slot/port</code>                    | Enters global configuration mode.                                                                                                           |
| <b>Step 3</b> | <code>switch(config-if)# [no] power efficient-ethernet auto</code>           | Enables or disables EEE on the specified interface. When EEE is enabled, the device advertises and auto negotiates EEE to its link partner. |
| <b>Step 4</b> | (Optional) <code>switch(config-if)# show interface ethernet slot/port</code> | Displays the EEE status on the interface.                                                                                                   |
| <b>Step 5</b> | (Optional) <code>switch(config)# copy running-config startup-config</code>   | Saves the change persistently through reboots and restarts by copying the running configuration to the startup configuration.               |

## 19.8.2 Configuring the EEE LPI Sleep Threshold

You can configure the EEE LPI sleep threshold on an interface to specify how aggressively you want it to go to sleep.

**Before you begin**

Make sure that you are in the correct VDC. To change the VDC, use the `switchto vdc` command.

**Procedure**

|               | <b>Command or Action</b>                                                                 | <b>Purpose</b>                                                                                                                                                                                                                                                                                                                                                                                                               |
|---------------|------------------------------------------------------------------------------------------|------------------------------------------------------------------------------------------------------------------------------------------------------------------------------------------------------------------------------------------------------------------------------------------------------------------------------------------------------------------------------------------------------------------------------|
| <b>Step 1</b> | <code>switch# configure terminal</code>                                                  | Places you in global configuration mode.                                                                                                                                                                                                                                                                                                                                                                                     |
| <b>Step 2</b> | <code>switch(config)# interface ethernet slot/port</code>                                | Enters global configuration mode.                                                                                                                                                                                                                                                                                                                                                                                            |
| <b>Step 3</b> | <code>switch(config-if)# [no] power efficient-ethernet sleep threshold aggressive</code> | Configures the EEE LPI sleep threshold on the interface to be aggressive or nonaggressive. The no form of this command enables the nonaggressive threshold. <ul style="list-style-type: none"> <li>Aggressive—Causes the device to enter LPI mode after 20 microseconds of detecting an idle state.</li> <li>Nonaggressive—Causes the device to enter LPI mode after 600 microseconds of detecting an idle state.</li> </ul> |
| <b>Step 4</b> | (Optional) <code>switch(config)# copy running-config startup-config</code>               | Saves the change persistently through reboots and restarts by copying the running configuration to the startup configuration.                                                                                                                                                                                                                                                                                                |

## 19.9 Verifying the EEE Configuration

To display the EEE configuration, perform one of the following tasks:

Table 37 EEE on an Ethernet interface

| <b>Command</b>                             | <b>Purpose</b>                    |
|--------------------------------------------|-----------------------------------|
| <code>show environment power detail</code> | Displays the current power usage. |

| Command                                                    | Purpose                                                                                                                                                                                                                                                                                                                                                                                                                                                                                                                                                                                                                                                                                                                   |
|------------------------------------------------------------|---------------------------------------------------------------------------------------------------------------------------------------------------------------------------------------------------------------------------------------------------------------------------------------------------------------------------------------------------------------------------------------------------------------------------------------------------------------------------------------------------------------------------------------------------------------------------------------------------------------------------------------------------------------------------------------------------------------------------|
| <b>show interface ethernet slot/port</b>                   | Displays the EEE status on the interface. The options are as follows: <ul style="list-style-type: none"> <li>N/A—The interface is not capable of EEE.</li> <li>Disabled—EEE is disabled on this interface.</li> <li>Disagreed—EEE autonegotiation with the link partner has failed</li> <li>Operational—EEE is enabled and operational on this interface.</li> </ul>                                                                                                                                                                                                                                                                                                                                                      |
| <b>show interface ethernet slot/port capabilities</b>      | Displays whether the interface is EEE capable.                                                                                                                                                                                                                                                                                                                                                                                                                                                                                                                                                                                                                                                                            |
| <b>show interface ethernet slot/port counters detailed</b> | Displays the following EEE statistics on the interface: <ul style="list-style-type: none"> <li>Tx LPI uses—The amount of time (in microseconds) that the transmitting link partner waits before it starts transmitting data after leaving LPI mode.</li> <li>Rx LPI uses—The amount of time (in microseconds) that the receiving link partner requests that the transmitting link partner wait before transmitting data after leaving LPI mode.</li> <li>Tx LPI requests—The number of times that the transmitting link partner makes a request to enter LPI mode.</li> <li>Rx LPI indications—The number of times the receiving link partner detects that the transmitting link partner has entered LPI mode.</li> </ul> |

## 19.10 Configuration Examples for EEE

### Example

This example shows how to enable EEE on an Ethernet interface:

```
switch# config t
switch(config)# interface ethernet 7/1
switch(config-if)# power efficient-ethernet auto
switch(config-if)# power efficient-ethernet sleep threshold aggressive
switch(config-if)# show interface ethernet 7/1
Ethernet7/1 is up
EEE(efficient-ethernet): Operational
```

## 19.11 Related Documents

| Related Topic    | Document Title                                                               |
|------------------|------------------------------------------------------------------------------|
| EEE CLI commands | <i>Inspur CN12700 Series INOS System Management Command Reference</i>        |
| VDCs             | <i>Inspur CN12700 Series INOS Virtual Device Context Configuration Guide</i> |

## 19.12 Feature History for EEE

The table below summarizes the new and changed features for this document and shows the releases in which each feature is supported. Your software release might not support all the features in this document. For the latest caveats and feature information, the release notes for your software release.

Table 38 Feature History for EEE

| Feature Name | Releases | Feature Information          |
|--------------|----------|------------------------------|
| EEE          | 6.1(2)   | This feature was introduced. |

# CHAPTER 20 Configuring GIR (Inspur INOS Release 7.3(0)D1(1) and later releases)

---

This chapter includes the following sections:

- Information About GIR
- Guidelines and Limitations for GIR
- Configuring Custom Maintenance Mode and Custom Normal Mode Profile
- Creating a Snapshot
- Adding Show Commands to Snapshots
- Dumping Snapshot Sections
- Entering Maintenance Mode
- Returning to Normal Mode
- Deleting a Maintenance Profile
- Configuration Examples for GIR
- Verifying GIR
- Feature History for GIR

## 20.1 Information About GIR

You can use Graceful Insertion and Removal (GIR) to put a switch in maintenance mode in order to perform debugging or an upgrade. When switch maintenance is complete, you can return the switch to normal mode.

When you place the switch in maintenance mode, all protocols are isolated from the network. When normal mode is restored, all the protocols are brought back up.

In Inspur INOS 7.2(0)D1(1) release, the default mode for GIR is “shutdown”. When you place the switch in maintenance mode, all protocols are gracefully brought down and all physical ports are shut down. When normal mode is restored, all the protocols and ports are brought back up. The following protocols are supported:

- Border Gateway Protocol (BGP)
- BGPv6
- Enhanced Interior Gateway Routing Protocol (EIGRP)
- EIGRPv6
- Intermediate System-to-Intermediate System (ISIS)
- ISISv6
- Open Shortest Path First (OSPF)
- OSPFv3
- RIP

Also supported are:

- Virtual port channel (vPC) switches
- Interfaces
- FabricPath

Starting with Inspur INOS Release 7.3(0)D1(1), the default mode for GIR is “isolate”. Use the system mode maintenance command to put all the enabled protocols in maintenance mode. The switch will use the isolate command to isolate the protocols from the network. The switch will then be isolated from the network but is not shut



down. Routing protocols will be running on the switch to maintain neighborhood with peer switches when it is isolated from the network. The isolate command is applied on the protocol instance and is applicable for the following protocols:

- Border Gateway Protocol (BGP)
- BGPv6
- Enhanced Interior Gateway Routing Protocol (EIGRP)
- EIGRPv6
- Intermediate System-to-Intermediate System (ISIS)
- ISISv6
- Open Shortest Path First (OSPF)
- OSPFv3
- FabricPath (Only applicable for Spine switches)

## 20.1.1 Maintenance Profile

Maintenance profile contains a set of commands that will be applied sequentially during graceful removal or graceful insertion.

By default, the system isolates all enabled protocols during graceful removal and restores them during graceful insertion. The protocols are isolated and restored in a predefined order.

The switch supports the following profiles:

- Maintenance-mode profile—Contains all the commands that will be executed during graceful removal, when the switch enters maintenance mode.
- Normal-mode profile—Contains all the commands that will be executed during graceful insertion, when the switch returns to normal mode.

### System-generated Profile

You can allow the system to generate a maintenance-mode or normal-mode profile with specific configuration commands. The system generates a maintenance-mode profile when you use the system mode maintenance command or a normal-mode profile when you use the no system mode maintenance command.

### Custom Profile

You can create a custom maintenance-mode or normal-mode profile with configuration commands that can be applied during graceful removal or graceful insertion to isolate, shut down, or restore the protocols individually (or perform additional configurations). You can use a custom profile when the system-generated profile does not provide the required configuration or if you need to enhance the existing system-generated or custom profile to include additional functionality specific to your deployment. Use the configure maintenance profile maintenance-mode command to configure a custom maintenance-mode profile with the required commands or the configure maintenance profile normal-mode command to configure a custom normal-mode profile with the required commands.

The system-generated profile will overwrite the custom profile and vice-versa. The system can have either a system-generated maintenance-mode profile or a custom maintenance-mode profile at a time. Similarly, the system can have either a system-generated normal-mode profile or a custom normal-mode profile at a time. The scenarios are as given in the figure below:

Figure 7 Maintenance Profile Scenarios

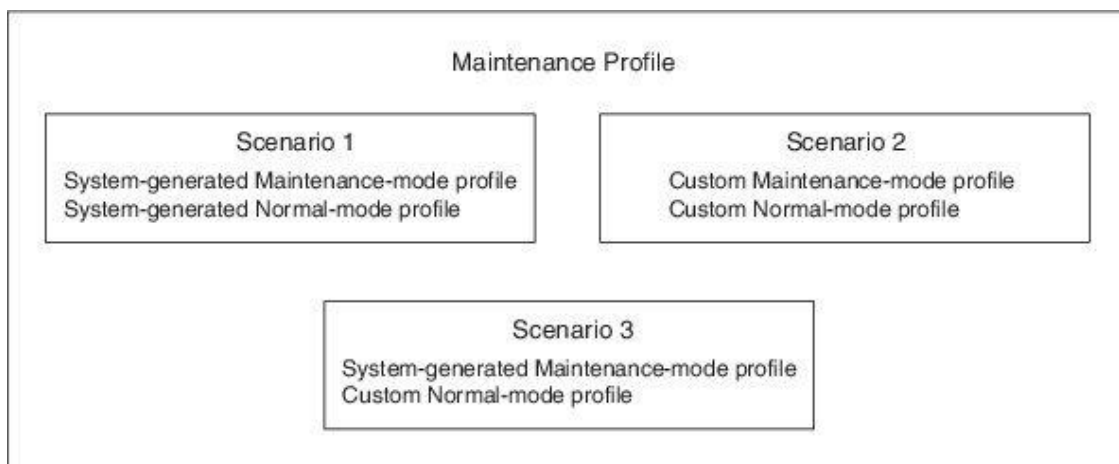

## 20.1.2 Unplanned Maintenance

You can put the switch in unplanned maintenance mode when the switch reloads due to a critical failure. For switches with a single supervisor, configure a reset reason CLI using the system mode maintenance on-reload reset-reason command to enable the switch to go into maintenance mode after a switch reloads due to a critical failure. For switches with dual supervisors, SUP switchover occurs when there is a critical failure of the switch and the switch will not go into maintenance mode. The maintenance-mode profile existing in the startup configuration is applied when the switch goes in to unplanned maintenance mode. If no maintenance mode profile exists in the startup configuration, a system-generated maintenance-mode profile is created and applied when the switch goes in to unplanned maintenance mode.

## 20.1.3 Maintenance Mode Timer

Use the system mode maintenance timeout command before entering maintenance mode to keep the switch in maintenance mode for a specified number of minutes. You can also use this command while the switch is in maintenance mode to change the number of minutes for which the switch will be in maintenance mode. The timer will then restart from that instant with the new timer value. Once the configured time elapses, the switch returns to normal mode automatically without using the no system mode maintenance mode command. Use the no system mode maintenance timeout command to disable the timer.

## 20.1.4 Snapshot

Use the snapshot command to capture the running states of selected features and to store the running states on the persistent storage media.

You can use snapshots to compare the state of a switch before it went into maintenance mode and after it came back to normal mode. The snapshot process consists of three parts:

- Creating a snapshot of the states of a few preselected features on the switch and storing them on the persistent storage media.
- Listing the snapshots taken at various time intervals and managing them.
- Comparing snapshots and showing the summary and details of each feature.

There are two types of snapshots:

- **System-generated snapshot**—This is generated by the system when you use the [no] system mode maintenance command. The system creates the before\_maintenance snapshot just before the system goes into maintenance mode. The system creates the after\_maintenance snapshot just before the system goes into normal mode. The system overwrites any old snapshots when you use the [no] system mode maintenance command. Use the snapshot delete {all | snapshot-name} command to delete the system-generated snapshots.

In certain scenarios, the system-generated after\_maintenance snapshot may be taken when hardware programming is ongoing. In such cases, we recommend taking a user-generated snapshot after the system has completed hardware programming and is in a stable state. You can then compare the new after\_maintenance snapshot with the before\_maintenance snapshot.

Starting with Inspur INOS release 8.0(1), the [no] system mode maintenance command has been enhanced to execute a normal mode profile and activate a timer ensuring that sufficient time is provided for the switch to complete any hardware programming that may be going on before the after\_maintenance snapshot is taken. Once the timer expires, the after\_maintenance snapshot is taken in the background and a new warning syslog message, MODE\_SNAPSHOT\_DONE, is sent after the snapshot is complete. The default delay timer value is 120 seconds. The output of the [no] system mode maintenance command displays the delay timer value, in seconds, after which the after\_maintenance snapshot is generated:

```
The after_maintenance snapshot will be generated in <delay> seconds
After that time, please use 'show snapshots compare before_maintenance after_maintenance' to check
the
health of the system
```

Use the system mode maintenance snapshot-delay [delay-in-seconds] command to change the delay timer value. The delay timer range is from 0 to 65535.

Use the show maintenance snapshot-delay command to display the snapshot delay timer value.

- **User-generated snapshot**—Use the snapshot create name description command to create a user-generated snapshot. Use the snapshot delete {all | snapshot-name} command to delete user-generated snapshots.

The system-generated and user-generated snapshots are stored in the snapshot repository.

Figure 8 Snapshot Repository

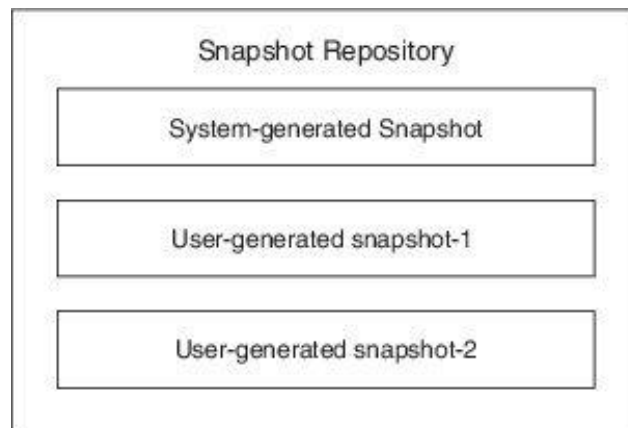

The following table lists the snapshot sections with the corresponding show commands:

| Name of the Section | Corresponding 'show' command     |
|---------------------|----------------------------------|
| bgp-sessions        | show bgp sessions vrf all        |
| eigrp               | show ip eigrp topology summary   |
| eigrpv6             | show ipv6 eigrp topology summary |

| Name of the Section | Corresponding 'show' command      |
|---------------------|-----------------------------------|
| interface           | show interface                    |
| ospf                | show ip ospf vrf all              |
| ospfv3              | show ipv6 ospfv3 vrf all          |
| isis                | show isis database detail vrf all |
| rip                 | show ip rip vrf all               |
| route-summary       | show ip route summary vrf all     |
| routev6-summary     | show ipv6 route summary vrf all   |
| vpc                 | show vpc                          |

## 20.1.5 Suppress FIB Pending

The Suppress Forwarding Information Base (FIB) Pending feature uses the Border Gateway Protocol-Routing Information Base (BGP-RIB) and the Enhanced Interior Gateway Routing Protocol-Routing Information Base (EIGRP-RIB) feedback mechanism to avoid premature route advertisements and subsequent packet loss in a network. This mechanism is enabled by default and ensures that routes are installed locally before they are advertised to a neighbor.

BGP and EIGRP wait for feedback from RIB indicating that the routes that EIGRP or BGP installed in the RIB are installed in the FIB before EIGRP or BGP sends out updates to the neighbors. EIGRP or BGP will send out updates of only those routes that have versions up to the version that FIB has installed. This selective update ensures that EIGRP or BGP does not send out premature updates resulting in attracting traffic even before the data plane is programmed after a switch reload, line card reload, or when the switch moves to normal mode from maintenance mode.

## 20.1.6 GIR SNMP Traps

Starting with Inspur INOS Release 8.0(1), support for Simple Network Management Protocol (SNMP) traps has been added to the Graceful Insertion and Removal (GIR) mechanism. You can enable the switch to send an SNMP trap notification when the switch moves from normal mode to maintenance mode and vice-versa. Use the `snmp-server enable traps mmode cseMaintModeChangeNotify` command to enable the switch to send an SNMP trap notification when the switch moves to maintenance mode. Use the `snmp-server enable traps mmode cseNormalModeChangeNotify` command to enable the switch to send an SNMP trap notification when the switch moves to normal mode. By default, both SNMP traps are disabled.

## 20.2 Guidelines and Limitations for GIR

- Custom maintenance profile has to be used for custom topologies and protocols that are not supported by automatic or system-generated profiles.
  - Before starting with maintenance, ensure that the switch is not attracting any data traffic after the switch has been put in maintenance mode. You can use counters and statistics to ensure that there is no data traffic on the switch.
  - Use the `system mode maintenance always-use-custom-profile` command when using custom profiles to ensure that the custom profile is not overwritten by the system-generated profile.
  - Snapshot information is not copied automatically to the standby supervisor in a dual supervisor system.
  - GIR may not provide zero application traffic loss for certain topologies and configurations.
  - Starting with Inspur INOS Release 7.3(0)D1(1), we recommend not using the `configure profile [maintenance-mode | normal-mode]` type admin command and we strongly recommend using the `configure maintenance profile [maintenance-mode | normal-mode]` command.
  - You cannot perform an in-service software upgrade (ISSU) or an in-service software downgrade (ISSD) in maintenance mode.

## 20.3 Configuring Custom Maintenance Mode and Custom Normal Mode Profile

You can create the maintenance-mode profile or normal-mode profile with configuration commands that can be applied during graceful removal or graceful insertion. We recommend using the system mode maintenance always-use-custom-profile command after configuring custom maintenance mode and custom normal mode profiles to ensure that custom profiles are always used during maintenance mode operations.

### Procedure

|        | Command or Action                                                             | Purpose                                                                                                                                                                                                                  |
|--------|-------------------------------------------------------------------------------|--------------------------------------------------------------------------------------------------------------------------------------------------------------------------------------------------------------------------|
| Step 1 | switch# <b>configure maintenance profile [maintenance-mode   normal-mode]</b> | Enters a configuration session for the maintenance-mode profile or the normal-mode profile.<br><b>Note</b> Depending on which protocols you have configured, enter the appropriate commands to bring down the protocols. |
| Step 2 | Required: switch# <b>end</b>                                                  | Closes the maintenance mode profile.                                                                                                                                                                                     |

### Example

This example shows how to create a custom maintenance mode profile:

```
switch# configure maintenance profile maintenance-mode
Please configure 'system mode maintenance always-use-custom-profile' if you want to
use
custom profile always for maintenance mode.
Enter configuration commands, one per line. End with CNTL/Z.
switch(config-mm-profile)# router bgp 100
switch(config-mm-profile-router)# isolate
switch(config-mm-profile-router)# exit
switch(config-mm-profile)# sleep instance 1 10
switch(config-mm-profile)# interface ethernet 1/1
switch(config-mm-profile-if-verify)# shutdown
switch(config-mm-profile-if-verify)# end
Exit maintenance profile mode.
```

This example shows how to create a custom normal mode profile:

```
switch# configure maintenance profile normal-mode
Please configure 'system mode maintenance always-use-custom-profile' if you want to
use
custom profile always for maintenance mode.
Enter configuration commands, one per line. End with CNTL/Z.
switch(config-mm-profile)# interface ethernet 1/1
switch(config-mm-profile-if-verify)# no shutdown
switch(config-mm-profile-if-verify)# exit
switch(config-mm-profile)# sleep instance 1 20
switch(config-mm-profile)# router bgp 100
switch(config-mm-profile-router)# no isolate
switch(config-mm-profile-router)# end
Exit maintenance profile mode.
switch# show maintenance profile
[Normal Mode]
interface Ethernet1/1
no shutdown
sleep instance 1 20
router bgp 100
no isolate
[Maintenance Mode]
router bgp 100
```

```

isolate
sleep instance 1 20
interface Ethernet1/1
shutdown

```

## 20.4 Creating a Snapshot

You can create a snapshot of the running states of selected features. When you create a snapshot, a predefined set of show commands are run and the outputs are saved.

### Procedure

|        | Command or Action                                                                                              | Purpose                                                                                                                                                                                                                                                                       |
|--------|----------------------------------------------------------------------------------------------------------------|-------------------------------------------------------------------------------------------------------------------------------------------------------------------------------------------------------------------------------------------------------------------------------|
| Step 1 | switch# <b>snapshot create</b> <i>name description</i>                                                         | Creates a snapshot. The <i>name</i> variable can be 64 characters in length. The <i>description</i> variable can be 256 characters in length.<br>Use the <b>snapshot delete</b> { <b>all</b>   <i>snapshot-name</i> } command to delete all snapshots or a specific snapshot. |
| Step 2 | (Optional) switch# <b>show snapshots</b>                                                                       | Displays snapshots present on the switch.                                                                                                                                                                                                                                     |
| Step 3 | (Optional) switch# <b>show snapshots compare</b><br><i>snapshot-name-1 snapshot-name-2</i><br><b>[summary]</b> | Displays a comparison of two snapshots. The <b>summary</b> keyword displays just enough information to see the overall changes between the two snapshots.                                                                                                                     |

### Example

This example shows how to create a snapshot:

```

switch# snapshot create before_maint taken before maint
Executing 'show interface'... Done
Executing 'show ip route summary vrf all'... Done
Executing 'show ipv6 route summary vrf all'... Done
Executing 'show bgp sessions vrf all'... Done Executing
'show ip eigrp topology summary'... Done Executing
'show ipv6 eigrp topology summary'... Done Executing
'show vpc'... Done
Executing 'show ip ospf vrf all'... Done
Feature 'ospfv3' not enabled, skipping...
Executing 'show isis database detail vrf all'... Done
Executing 'show ip rip vrf all'... Done
Executing user-specified 'show ip route detail vrf all'... Done
Snapshot 'before_maint' created

```

This example shows how to display the snapshots present on the switch:

```

switch# show snapshots
Snapshot Name Time Description

before_maint Wed Oct 14 10:56:50 2015 taken before maint

```

This example displays a comparison between two snapshots:

```

switch# show snapshots compare before_maintenance after_maintenance summary
=====
Feature changed before_maintenance after_maintenance
=====
basic summary
of interfaces 50 50

```

```

of vlans 0 0
of ipv4 routes vrf default 13 13
of ipv4 paths vrf default 13 13
of ipv4 routes vrf management 14 14
of ipv4 paths vrf management 14 14
of ipv6 routes vrf default 3 3
of ipv6 paths vrf default 3 3

interfaces
of eth interfaces 48 48
of eth interfaces up 1 1
of eth interfaces down 47 47
of eth interfaces other 0 0

of vlan interfaces 0 0
of vlan interfaces up 0 0
of vlan interfaces down 0 0
of vlan interfaces other 0 0

```

This example shows how to delete a snapshot:

```

switch# snapshot delete before_maint
switch# show snapshots
Snapshot Name Time Description

```

## 20.5 Adding Show Commands to Snapshots

You can specify additional show commands to be captured in snapshots. These show commands are defined in user-specified snapshot sections.

### Procedure

|               | Command or Action                                                                                                                    | Purpose                                                                                                                                                                                                                                                                                                                                                                                                                                                                                                                                                                                                                                                                                                                                                                                           |
|---------------|--------------------------------------------------------------------------------------------------------------------------------------|---------------------------------------------------------------------------------------------------------------------------------------------------------------------------------------------------------------------------------------------------------------------------------------------------------------------------------------------------------------------------------------------------------------------------------------------------------------------------------------------------------------------------------------------------------------------------------------------------------------------------------------------------------------------------------------------------------------------------------------------------------------------------------------------------|
| <b>Step 1</b> | switch# <b>snapshot section add</b> <i>section</i> " <i>show-command</i> " <i>row-id</i> <i>element-key1</i> [ <i>element-key2</i> ] | <p>Adds a user-specified section to snapshots. The <i>section</i> variable is used to name the <b>show</b> command output. You can use any word to name the section.</p> <p>The <b>show</b> command must be enclosed in quotation marks. Non-<b>show</b> commands will not be accepted.</p> <p>The <i>row-id</i> argument specifies the tag of each row entry of the <b>show</b> command's XML output. The <i>element-key1</i> and <i>element-key2</i> arguments specify the tags used to distinguish among row entries. In most cases, only the <i>element-key1</i> argument needs to be specified to be able to distinguish among row entries.</p> <p><b>Note</b> To delete a user-specified section from snapshots, use the <b>snapshot section delete</b> <i>section</i> section command.</p> |
| <b>Step 2</b> | (Optional) switch# <b>show snapshots sections</b>                                                                                    | Displays the user-specified snapshot sections.                                                                                                                                                                                                                                                                                                                                                                                                                                                                                                                                                                                                                                                                                                                                                    |

### Example

The following example shows how to add the show ip route detail vrf all command to the snapshot:

```

switch# snapshot section add v4route "show ip route detail vrf all" ROW_prefix
ipprefix
switch# show snapshots sections
user-specified snapshot sections

[v4route]
show command: show ip route detail vrf all
row id: ROW_prefix
key1: ipprefix
key2: -

```

The following example shows how to add the show ipv6 route detail vrf all command to the snapshot:

```

switch# snapshot section add routev6 "show ipv6 route detail vrf all" ROW_prefix
ipprefix
added section "routev6"
switch# show snapshots sections
user-specified snapshot sections

[routev6]
show command: show ipv6 route detail vrf all
row id: ROW_prefix
key1: ipprefix
key2: -

```

The following example shows how to delete a user-specified snapshot section:

```

switch# snapshot section delete v4route
deleted section "v4route"
switch# show snapshots sections
user-specified snapshot sections

none

```

The following example displays the XML output of the show ip route detail vrf all command:

```

switch(config)# show ip route detail vrf all | xml
<?xml version="1.0" encoding="ISO-8859-1"?>
<nf:rpc-reply xmlns:nf="urn:ietf:params:xml:ns:netconf:base:1.0"
xmlns="http://www.inspur.com/nxos:7.3.0.D1.1.1:urib">
 <nf:data>
 <show>
 <ip>
 < readonly >
 <TABLE_vrf>
 <ROW_vrf>
 <vrf-name-out>default</vrf-name-out>
 <TABLE_addrf>
 <ROW_addrf>
 <addrf>ipv4</addrf>
 <ddrf>
 <TABLE_prefix>
 <ROW_prefix>
 <ipprefix>0.0.0.0/32</ipprefix>
 >
 <ucast-nhops>1</ucast-nhops>
 <mcast-nhops>0</mcast-nhops>
 <attached>>false</attached>
 ... <snip>
 </ROW_prefix>
 </TABLE_prefix>
 </ddrf>
 </TABLE_addrf>
 </ROW_vrf>
 </TABLE_vrf>
 </readonly>
 </ip>
 </show>
 </nf:data>
 </nf:rpc-reply>

```



## 20.6 Dumping Snapshot Sections

### Procedure

|        | Command or Action                                       | Purpose                                                               |
|--------|---------------------------------------------------------|-----------------------------------------------------------------------|
| Step 1 | switch# <b>show snapshots dump</b> <i>snapshot-name</i> | Displays the content of the various sections in a generated snapshot. |

### Example

The following example shows how to dump content of the various sections in a generated snapshot:

```
switch# show snapshots dump new
File: interface.xml Snapshot: new
=====
<?xml version="1.0" encoding="ISO-8859-1"?>
<nf:rpc-reply xmlns:nf="urn:ietf:params:xml:ns:netconf:base:1.0" xmlns="http://www.Inspur.com/nxos:7.3.0.D1.1.:if_manager">
 <nf:data>
 <show>
 <interface>
 < readonly >
 <TABLE_interface>
 <ROW_interface>
 <interface>mgmt0</interface>
 <state>up</state>
 <admin_state>up</admin_state>
 <eth_hw_desc>GigabitEthernet</eth_hw_desc>
 <eth_hw_addr>5cfc.666d.3b34</eth_hw_addr>
 <eth_bia_addr>5cfc.666d.3b34</eth_bia_addr>
 <eth_ip_addr>5.24.100.101</eth_ip_addr>
 <eth_ip_mask>16</eth_ip_mask>
 <eth_ip_prefix>5.24.0.0</eth_ip_prefix>
 <eth_mtu>1500</eth_mtu>
 ... <snip> ...
```

## 20.7 Entering Maintenance Mode

### Procedure

|        | Command or Action                                                                                                                                                                                                                                                                                   | Purpose                                                                                                                                                                                                                                                                                                                                                                                                                                                                                                                                                                                                                                                                                                                  |
|--------|-----------------------------------------------------------------------------------------------------------------------------------------------------------------------------------------------------------------------------------------------------------------------------------------------------|--------------------------------------------------------------------------------------------------------------------------------------------------------------------------------------------------------------------------------------------------------------------------------------------------------------------------------------------------------------------------------------------------------------------------------------------------------------------------------------------------------------------------------------------------------------------------------------------------------------------------------------------------------------------------------------------------------------------------|
| Step 1 | switch# <b>configure terminal</b>                                                                                                                                                                                                                                                                   | Enters global configuration mode.                                                                                                                                                                                                                                                                                                                                                                                                                                                                                                                                                                                                                                                                                        |
| Step 2 | Required: switch(config)# <b>system mode maintenance</b> [ <b>always-use-custom-profile</b>   <b>dont-generate-profile</b>   <b>non-interactive</b>   <b>on-reload reset-reason</b> <i>reason</i>   <b>shutdown</b>   <b>snapshot-delay</b> <i>delay-in-seconds</i>   <b>timeout</b> <i>value</i> ] | <p>Puts all enabled protocols in maintenance mode (using the <b>isolate</b> command).</p> <p>Use the <b>dont-generate-profile</b> and <b>shutdown</b> options to put the switch in maintenance mode.</p> <ul style="list-style-type: none"> <li><b>dont-generate-profile</b>—Prevents the dynamic searching of enabled protocols and executes commands configured in a maintenance mode profile. Use this option if you want the system to execute commands in a custom maintenance mode profile.</li> <li><b>shutdown</b>—Shuts down all protocols and interfaces except the management interface (using the <b>shutdown</b> command). This option is disruptive while the default (using the <b>isolate</b></li> </ul> |

|  | Command or Action | Purpose                                                                                                                                                                                                                                                                                                                                                                                                                                                                                                                                                                                                                                                                                                                                                                                                                                                                                                                                                                                                                                                                                                                                                                                                                                                                                                                                                                                                                                                                                                                                                                                                                                                                                                                                                                                                                                                                                                                                                                                                                                                       |
|--|-------------------|---------------------------------------------------------------------------------------------------------------------------------------------------------------------------------------------------------------------------------------------------------------------------------------------------------------------------------------------------------------------------------------------------------------------------------------------------------------------------------------------------------------------------------------------------------------------------------------------------------------------------------------------------------------------------------------------------------------------------------------------------------------------------------------------------------------------------------------------------------------------------------------------------------------------------------------------------------------------------------------------------------------------------------------------------------------------------------------------------------------------------------------------------------------------------------------------------------------------------------------------------------------------------------------------------------------------------------------------------------------------------------------------------------------------------------------------------------------------------------------------------------------------------------------------------------------------------------------------------------------------------------------------------------------------------------------------------------------------------------------------------------------------------------------------------------------------------------------------------------------------------------------------------------------------------------------------------------------------------------------------------------------------------------------------------------------|
|  |                   | <p>command) is not.</p> <p>The <b>on-reload reset-reason, timeout</b> and <b>always-use-custom-profile</b> options are used to configure maintenance mode parameters and will not put the switch in maintenance mode.</p> <ul style="list-style-type: none"> <li>• <b>timeout value</b>—Keeps the switch in maintenance mode for a specified number of minutes. The range is from 5 to 65535. We recommend setting the timeout value to at least 60 minutes. Once the configured time elapses, the switch returns to normal mode automatically. The <b>no system mode maintenance timeout</b> command disables the timer</li> <li>• <b>on-reload reset-reason reason</b>—Boots the switch into maintenance mode automatically in the event of a specified system crash. The <b>no system mode maintenance on-reload reset-reason</b> command prevents the switch from being brought up in maintenance mode in the event of a system crash. The maintenance mode reset reasons are as follows: <ul style="list-style-type: none"> <li>• <b>HW_ERROR</b>—Hardware error</li> <li>• <b>SVC_FAILURE</b>—Critical service failure</li> <li>• <b>KERN_FAILURE</b>—Kernel panic</li> <li>• <b>WDOG_TIMEOUT</b>—Watchdog timeout</li> <li>• <b>FATAL_ERROR</b>—Fatal error</li> <li>• <b>MANUAL_RELOAD</b>—Manual reload</li> <li>• <b>MAINTENANCE</b>—Reloads the switch in maintenance mode if the switch was already in maintenance mode before reload.</li> <li>• <b>MATCH_ANY</b>—Any of the above reasons</li> <li>• <b>ANY_OTHER</b>—Any reload reason not specified above.</li> </ul> </li> </ul> <p>The system prompts you to continue. Enter y to continue or n to terminate the process.</p> <p><b>Note</b> We recommend configuring the reset reason and saving it to the startup configuration. This enables the switch to go into the maintenance mode after a switch reloads due to any reason.</p> <ul style="list-style-type: none"> <li>• <b>always-use-custom-profile</b>—Use this option to apply the existing custom maintenance mode</li> </ul> |

|               | Command or Action                          | Purpose                                                                                                                                                                                                                                                                                                                                                                                                                                                                                                                                                                                                                                                                                                                                                                         |
|---------------|--------------------------------------------|---------------------------------------------------------------------------------------------------------------------------------------------------------------------------------------------------------------------------------------------------------------------------------------------------------------------------------------------------------------------------------------------------------------------------------------------------------------------------------------------------------------------------------------------------------------------------------------------------------------------------------------------------------------------------------------------------------------------------------------------------------------------------------|
|               |                                            | <p>profile and prevent creation of autogenerated maintenance mode profile. This option forces the dont-generate-profile option to be used even if it has not been specified using the <b>system mode maintenance</b> command. You cannot use the "shutdown" option when this option is being used.</p> <p>Starting from Inspur INOS Release 8.0(1), the following keywords were introduced:</p> <ul style="list-style-type: none"> <li>• <b>non-interactive</b>—Use this option to put the switch in maintenance mode without presenting any switch prompts.</li> <li>• <b>snapshot-delay</b> <i>delay-in-seconds</i>—Use this option to change the snapshot delay timer value. The default snapshot delay timer value is 120 seconds. The range is from 0 to 65535.</li> </ul> |
| <b>Step 3</b> | (Optional) switch# <b>show system mode</b> | Displays the current system mode. This command also displays the current state of the maintenance mode timer when the switch is in maintenance mode.                                                                                                                                                                                                                                                                                                                                                                                                                                                                                                                                                                                                                            |

### Example

This example shows how to put all the protocols in maintenance mode using the system mode maintenance command on a switch running the Inspur INOS Release 8.0(1):

```

switch# configure terminal
switch(config)# system mode maintenance
Following configuration will be applied:

router bgp 100
 isolate
router ospf 100
 isolate
router isis 100
 isolate

Do you want to continue (y/n)? [no] y

Generating before_maintenance snapshot before going into maintenance mode

Starting to apply commands...

Applying : router bgp 100
Applying : isolate
Applying : router ospf 100
Applying : isolate
Applying : router isis 100
Applying : isolate

Maintenance mode operation successful.
switch(maint-mode) (config)# 2016 Dec 5 06:19:13 switch %$ VDC-1 %$ %MMODE-2-
MODE_CHANGED:
System changed to "maintenance" mode.
switch(maint-mode) (config)#

```

This example shows how to put all the protocols in maintenance mode using the system mode maintenance command on a switch running the Inspur INOS Release 7.3(0)D1(1):

```
switch# configure terminal
switch(config)# system mode maintenance
Following configuration will be applied:

router bgp 100
 isolate
router ospf 100
 isolate
router isis 100
 isolate

Do you want to continue (y/n)? [no] y

Generating a snapshot before going into maintenance mode

Starting to apply commands...

Applying : router bgp 100
Applying : isolate
Applying : router ospf 100
Applying : isolate
Applying : router isis 100
Applying : isolate
Maintenance mode operation successful.
```

This example shows how to shut down all protocols and interfaces on the switch:

```
switch# configure terminal
switch(config)# system mode maintenance shutdown
Following configuration will be applied:

router bgp 64581
 shutdown
router eigrp p2
 shutdown
 address-family ipv6 unicast
 shutdown
router eigrp 0
 shutdown
 address-family ipv6 unicast
 shutdown
router ospf 200
 shutdown
router isis 70
 shutdown
vpc domain 2
 shutdown
system interface shutdown

NOTE: 'system interface shutdown' will shutdown all interfaces excluding mgmt 0
Do you want to continue (yes/no)? [no] yes

Generating a snapshot before going into maintenance mode

Starting to apply commands...

Applying : router bgp 64581
Applying : shutdown
```

```

Applying : router eigrp p2
Applying : shutdown
Applying : address-family ipv6 unicast
Applying : shutdown
Applying : router eigrp 0
Applying : shutdown
Applying : address-family ipv6 unicast
Applying : shutdown
Applying : router ospf 200
Applying : shutdown
Applying : router isis 70
Applying : shutdown
Applying : vpc domain 2
Applying : shutdown2016 Jan 15 11:10:36.080386 CP-BL26-CN127-1A %$ VDC-1 %$
%VPC-2-VPC_SHUTDOWN: vPC shutdown status is ON

Applying : system interface shutdown

Maintenance mode operation successful.
switch(config)# 2016 Jan 15 11:10:42.057678 switch %$ VDC-1 %$ %MMODE-2-
MODE_CHANGED: System
changed to "maintenance" mode.
2016 Jan 15 11:10:42.058167 switch %$ VDC-1 %$ %MMODE-2-MODE_CHANGE_WARN: System
will be
moved to "normal" mode in 5 minutes

```

This example shows how to keep the switch in maintenance mode for a specific number of minutes:

```

switch# configure terminal
switch (config)# system mode maintenance timeout 25
switch# show system mode
System Mode: Maintenance
Maintenance Mode Timer: 24 minutes 55 seconds remaining

```

This example shows how to automatically boot the switch into maintenance mode if a fatal error occurs:

```

switch# configure terminal
switch(config)# system mode maintenance on-reload reset-reason fatal_error

```

This example shows how to place the switch in maintenance mode by using a previously created maintenance mode profile :

```

switch# configure terminal
switch(config)# system mode maintenance dont-generate-profile

```

Following configuration will be applied:

```

router bgp 100
 isolate
 sleep instance 1 10
interface Ethernet1/1
 shutdown

Do you want to continue (y/n)? [no] y

Generating a snapshot before going into maintenance mode

Starting to apply commands...

Applying : router bgp 100
Applying : isolate
Applying : sleep instance 1 10

```

```
Applying : interface Ethernet1/1
Applying : shutdown
Maintenance mode operation successful.
```

This example shows how to apply the existing custom maintenance mode profile and prevent creation of auto-generated maintenance mode profile:

```
switch# configure terminal
switch(config)# system mode maintenance always-use-custom-profile
```

This example shows how to put the switch in maintenance mode without presenting any switch prompts:

```
switch# configure terminal
switch(config)# system mode maintenance non-interactive
System mode switch to maintenance mode started. Will continue in background.
switch(config)# 2016 Dec 5 08:46:42 switch %$ VDC-1 %$ %MMODE-2-MODE_CHANGED:
System
changed
to "maintenance" mode.
switch(maint-mode) (config)#
```

This example shows how to change the snapshot delay timer value:

```
switch# configure terminal
switch(config)# system mode maintenance snapshot-delay 150
```

## 20.8 Returning to Normal Mode

### Procedure

|        | Command or Action                                                                             | Purpose                                                                                                                                                                                                                                                                                                                                                                                                                                                                                                                                                                                                                                                                                                                                                                                                                                                   |
|--------|-----------------------------------------------------------------------------------------------|-----------------------------------------------------------------------------------------------------------------------------------------------------------------------------------------------------------------------------------------------------------------------------------------------------------------------------------------------------------------------------------------------------------------------------------------------------------------------------------------------------------------------------------------------------------------------------------------------------------------------------------------------------------------------------------------------------------------------------------------------------------------------------------------------------------------------------------------------------------|
| Step 1 | switch# <b>configure terminal</b>                                                             | Enters global configuration mode.                                                                                                                                                                                                                                                                                                                                                                                                                                                                                                                                                                                                                                                                                                                                                                                                                         |
| Step 2 | Required: switch# <b>no system mode maintenance [dont-generate-profile   non-interactive]</b> | Executes a previously created normal mode profile file or a dynamically created normal mode profile file. The <b>dont-generate-profile</b> keyword suppresses the creation of the normal mode maintenance profile and also prevents reusing the existing normal mode maintenance profile. The <b>non-interactive</b> keyword enables the switch to exit the maintenance mode without presenting any switch prompts. The system prompts you to continue. Enter <b>y</b> to continue or <b>n</b> to terminate the process. Starting from Inspur INOS Release 8.0(1), the <b>non-interactive</b> keyword was introduced. The <b>non-interactive</b> keyword puts the switch in normal mode from maintenance mode without presenting any switch prompts.<br><b>Note</b> For large configurations, the interfaces will be up after a certain interval of time. |

### Example

This example shows how to return to normal mode from maintenance mode on a switch running the Inspur INOS Release 8.0(1):

```
switch(maint-mode) (config)# no system mode maintenance
Following configuration will be applied:

interface Ethernet1/1 no
```

```

shutdown
sleep instance 1 20
router bgp 100 no
 isolate

Do you want to continue (y/n)? [no] yes

Starting to apply commands...

Applying : interface Ethernet1/1
Applying : no shutdown Applying :
sleep instance 1 20 Applying :
router bgp 100 Applying : no
isolate

Maintenance mode operation successful.

The after_maintenance snapshot will be generated in 120 seconds
After that time, please use 'show snapshots compare before_maintenance
after_maintenance' to
check the health of the system
switch(config)# 2016 Dec 5 06:20:23 switch %$ VDC-1 %$ %MMODE-2-MODE_CHANGED:
 System changed
 to "normal" mode.
switch# show system mode
System Mode: Normal

```

This example shows how to return to normal mode from maintenance mode on a switch running the Inspur INOS Release 7.3(0)D1(1):

```

switch# configure terminal
switch(config)# no system mode maintenance
Following configuration will be applied:

interface Ethernet1/1 no
 shutdown
sleep instance 1 20
router bgp 100
no isolate

Do you want to continue (y/n)? [no] yes

Starting to apply commands...

Applying : interface Ethernet1/1
Applying : no shutdown
Applying : sleep instance 1 20
Applying : router bgp 100
Applying : no isolate

Maintenance mode operation successful.

Generating Current Snapshot

Please use 'show snapshots compare before_maintenance after_maintenance' to check
the
health of the system
switch(config)#
switch(config)# show system mode
System Mode: Normal

```

This example shows how to return to normal mode from maintenance mode by using the

dont-generate-profile keyword:

```
switch(config)# no system mode maintenance dont-generate-profile
Following configuration will be applied:

interface Ethernet1/1
 no shutdown
 sleep instance 1 20
 router bgp 100
 no isolate

Do you want to continue (y/n)? [no] yes

Starting to apply commands...

Applying : interface Ethernet1/1
Applying : no shutdown
Applying : sleep instance 1 20
Applying : router bgp 100
Applying : no isolate

Maintenance mode operation successful.

The after_maintenance snapshot will be generated in 120 seconds
After that time, please use 'show snapshots compare before_maintenance
after_maintenance'
to check the health of the system
switch(config)# 2016 Dec 5 08:51:46 switch %$ VDC-1 %$ %MMODE-2-MODE_CHANGED:
System
changed to "normal" mode.

switch(config)# show system mode
System Mode: Normal
```

This example shows how to return to normal mode from maintenance mode by using the non-interactive keyword:

```
switch(config)# no system mode maintenance non-interactive
System mode switch to normal mode started. Will continue in background.
switch(maint-mode)(config)# 2016 Dec 5 08:48:01 switch %$ VDC-1 %$ %MMODE-2-
MODE_CHANGED:
System changed to "normal" mode.
switch(config)# show system mode
System Mode: Normal
```

## 20.9 Deleting a Maintenance Profile

### Procedure

|        | Command or Action                                                                          | Purpose                                               |
|--------|--------------------------------------------------------------------------------------------|-------------------------------------------------------|
| Step 1 | switch# <b>configure terminal</b>                                                          | Enters global configuration mode.                     |
| Step 2 | Required: switch# <b>no configure maintenance profile {normal-mode   maintenance-mode}</b> | Deletes the normal mode or maintenance mode profiles. |

### Example

This example shows how to delete a maintenance profile:

```
switch# configure terminal
switch(config)# no configure maintenance profile maintenance-mode
```



## 20.10 Configuration Examples for GIR

This example shows how to create custom maintenance mode profile:

```
switch# configure maintenance profile maintenance-mode
Please configure 'system mode maintenance always-use-custom-profile' if you want to
use custom
profile always for maintenance mode.
Enter configuration commands, one per line. End with CNTL/Z.
switch(config-mm-profile)# router bgp 100
switch(config-mm-profile-router)# isolate
switch(config-mm-profile-router)# exit
switch(config-mm-profile)# sleep instance 1 10
switch(config-mm-profile)# interface ethernet 1/1
switch(config-mm-profile-if-verify)# shutdown
switch(config-mm-profile-if-verify)# end
Exit maintenance profile mode.
```

This example shows how to create custom normal mode profile:

```
switch# configure maintenance profile normal-mode
Please configure 'system mode maintenance always-use-custom-profile' if you want to
use custom
profile always for maintenance mode.
Enter configuration commands, one per line. End with CNTL/Z.
switch(config-mm-profile)# interface ethernet 1/1
switch(config-mm-profile-if-verify)# no shutdown
switch(config-mm-profile-if-verify)# exit
switch(config-mm-profile)# sleep instance 1 20
switch(config-mm-profile)# router bgp 100
switch(config-mm-profile-router)# no isolate
switch(config-mm-profile-router)# end
Exit maintenance profile mode.
```

This example shows how to create a custom maintenance mode and normal mode profile for IPv6 protocols:

```
switch# configure terminal
switch(config)# configure maintenance profile maintenance-mode
Please configure 'system mode maintenance always-use-custom-profile' if you want to
use custom
profile always for maintenance mode.
switch(config-mm-profile)# router ospfv3 ospf_ipv6
switch(config-mm-profile-router)# shutdown
switch(config-mm-profile-router)# exit
switch(config-mm-profile)# router eigrp 660
switch(config-mm-profile-router)# address-family ipv6 unicast
switch(config-mm-profile-router-af)# shutdown
switch(config-mm-profile-router-af)# exit
switch(config-mm-profile)# router isis isp
switch(config-mm-profile-router)# set-overload-bit always
switch(config-mm-profile-router)# address-family ipv6 unicast
switch(config-mm-profile-router-af)# shutdown
switch(config-mm-profile-router-af)# exit
switch# configure terminal
switch(config)# configure maintenance profile normal-mode
Please configure 'system mode maintenance always-use-custom-profile' if you want to
use custom
profile always for maintenance mode.
switch(config-mm-profile)# router isis isp
switch(config-mm-profile-router)# no set-overload-bit always
switch(config-mm-profile-router)# address-family ipv6 unicast
```

```

switch(config-mm-profile-router-af)# no shutdown
switch(config-mm-profile-router-af)# exit
switch(config-mm-profile)# router eigrp 660
switch(config-mm-profile-router)# address-family ipv6 unicast
switch(config-mm-profile-router-af)# no shutdown
switch(config-mm-profile-router-af)# exit
switch(config-mm-profile)# router ospfv3 ospf_ipv6
switch(config-mm-profile-router)# no shutdown
switch(config-mm-profile-router)# exit
switch# show maintenance profile
[Normal mode]
router isis isp
 no set-overload-bit always
 address-family ipv6 unicast
 no shutdown router eigrp 660
 address-family ipv6 unicast
 no shutdown
router ospfv3 ospf_ipv6
 no shutdown
[Maintenance Mode]
router ospfv3 ospf_ipv6
 shutdown
 router eigrp 660
 address-family ipv6 unicast
 shutdown
router isis isp
 set-overload-bit always
 address-family ipv6 unicast
 shutdown

```

This example shows how to create a custom maintenance mode profile and custom normal mode profile for VPC:

```

switch# configure terminal
switch(config)# configure maintenance profile maintenance-mode
switch(config-mm-profile)# router bgp 100
switch(config-mm-profile-router)# isolate
switch(config-mm-profile-router)# exit
switch(config-mm-profile)# interface port channel 5
switch(config-mm-profile-if-verify)# vpc orphan port suspend
switch(config-mm-profile-if-verify)# exit
switch(config-mm-profile)# interface port channel 6
switch(config-mm-profile-if-verify)# vpc orphan port
suspend switch(config-mm-profile-if-verify)# exit
switch(config-mm-profile)# sleep instance 1 5 switch(config-mm-profile)# vpc domain
1
switch(config-mm-profile-vpc-domain)# shutdown
switch# configure terminal
switch(config)# configure maintenance profile normal-mode
switch(config-mm-profile)# vpc domain 1
switch(config-mm-profile-vpc-domain)# no shutdown
switch(config-mm-profile-vpc-domain)# exit
switch(config-mm-profile)# sleep instance 1 60
switch(config-mm-profile)# interface port channel 5
switch(config-mm-profile-if-verify)# no vpc orphan port suspend
switch(config-mm-profile-if-verify)# exit
switch(config-mm-profile)# interface port channel 6
switch(config-mm-profile-if-verify)# no vpc orphan port suspend
switch(config-mm-profile-if-verify)# exit
switch(config-mm-profile)# router bgp 100
switch(config-mm-profile-router)# no isolate
switch# show maintenance profile
[Normal Mode]

```

```

vpc domain 1 no
 shutdown
sleep instance 1 60
interface port-channel 5
 no vpc orphan-port suspend
 interface port-channel 6
 no vpc orphan-port suspend router
 bgp 100
 no isolate
[Maintenance Mode]
router bgp 100
 isolate
interface port-channel 5 vpc
 orphan-port suspend
interface port-channel 6 vpc
 orphan-port suspend
sleep instance 1 5
vpc domain 1 shutdown

```

This example shows how to use the isolate command to put all protocols into maintenance mode:

```

switch(config)# system mode maintenance

Following configuration will be applied:

router bgp 100
 isolate

router ospf 100
 isolate

router isis 100
 isolate
Do you want to continue (y/n)? [no] y
Generating a snapshot before going into maintenance mode

Starting to apply commands...

Applying : router bgp 100
Applying : isolate
Applying : router ospf 100
Applying : isolate
Applying : router isis 100
Applying : isolate
Maintenance mode operation successful.

```

This example shows how to use the isolate command to put all protocols into maintenance mode on a switch running the Inspur INOS Release 8.0(1):

```

switch# configure terminal
switch(config)# system mode maintenance

Following configuration will be applied:

router bgp 100
 isolate
router ospf 100
 isolate
router isis 100
 isolate

Do you want to continue (y/n)? [no] y

Generating before_maintenance snapshot before going into maintenance mode

```

```

Starting to apply commands...

Applying : router bgp 100
Applying : isolate
Applying : router ospf 100
Applying : isolate
Applying : router isis 100
Applying : isolate

Maintenance mode operation successful.
switch(maint-mode)(config)# 2016 Dec 5 06:19:13 switch %$ VDC-1 %$ %MMODE-2-
MODE_CHANGED:
System changed to "maintenance" mode.
switch(maint-mode)(config)#

```

This example shows how to shut down all protocols and interfaces on the switch:

```

switch# configure terminal
switch(config)# system mode maintenance shutdown
Following configuration will be applied:

```

```

router bgp 64581
 shutdown
router eigrp p2
 shutdown
 address-family ipv6 unicast
 shutdown
router eigrp 0
 shutdown
 address-family ipv6 unicast
 shutdown
router ospf 200
 shutdown
router isis 70
 shutdown
vpc domain 2
 shutdown
system interface shutdown

```

NOTE: 'system interface shutdown' will shutdown all interfaces excluding mgmt 0 Do you want to continue (yes/no)? [no] yes

Generating a snapshot before going into maintenance mode

```

Starting to apply commands...

Applying : router bgp 64581
Applying : shutdown
Applying : router eigrp p2
Applying : shutdown
Applying : address-family ipv6 unicast
Applying : shutdown
Applying : router eigrp 0
Applying : shutdown
Applying : address-family ipv6 unicast
Applying : shutdown
Applying : router ospf 200
Applying : shutdown
Applying : router isis 70
Applying : shutdown
Applying : vpc domain 2
Applying : shutdown2016 Jan 15 11:10:36.080386 CP-BL26-CN127-1A %$ VDC-1 %$
%VPC-2-VPC_SHUTDOWN: vPC shutdown status is ON

Applying : system interface shutdown

```

```

Maintenance mode operation successful.
switch(config)# 2016 Jan 15 11:10:42.057678 CP-BL26-CN127-1A %$ VDC-1 %$ %MMODE-2-
MODE_CHANGED:
 System changed to "maintenance" mode.
2016 Jan 15 11:10:42.058167 CP-BL26-CN127-1A %$ VDC-1 %$ %MMODE-2-MODE_CHANGE_WARN:
System
will be moved to "normal" mode in 5 minutes

```

This example shows how to return to normal mode from maintenance mode:

```

switch# configure terminal
switch(config)# no system mode maintenance dont-generate-profile

Following configuration will be applied:
interface Ethernet1/1
 no shutdown
 sleep instance 1 20
router bgp 100 no
 isolate

Do you want to continue (y/n)? [no] yes
Starting to apply commands...
Applying : interface Ethernet1/1
Applying : no shutdown
Applying : sleep instance 1 20
Applying : router bgp 100
Applying : no isolate
Maintenance mode operation successful.
Generating Current Snapshot
Please use 'show snapshots compare before_maintenance after_maintenance' to check
the
health of the system

```

This example shows how to return to normal mode from maintenance mode on a switch running the Inspur INOS Release 8.0(1):

```

switch(maint-mode) (config)# no system mode maintenance
Following configuration will be applied:

interface Ethernet1/1
 no shutdown
sleep instance 1 20
router bgp 100
 no isolate

Do you want to continue (y/n)? [no] yes

Starting to apply commands...

Applying : interface Ethernet1/1
Applying : no shutdown
Applying : sleep instance 1 20
Applying : router bgp 100
Applying : no isolate

Maintenance mode operation successful.

The after_maintenance snapshot will be generated in 120 seconds
After that time, please use 'show snapshots compare before_maintenance
after_maintenance'
to check the health of the system
switch(config)# 2016 Dec 5 06:20:23 switch %$ VDC-1 %$ %MMODE-2-MODE_CHANGED:
System

```

```

changed to "normal" mode.
switch# show system mode
System Mode: Normal

```

This example shows how to create custom maintenance mode and normal mode profiles for FabricPath:

```

switch# configure maintenance profile maintenance-mode
Enter configuration commands, one per line. End with CNTL/Z.
switch(config-mm-profile)# fabricpath domain default
switch(config-mm-profile-fabricpath-isis)# set-overload-bit always
switch(config-mm-profile-fabricpath-isis)# end
Exit maintenance profile mode.
switch#
switch# configure maintenance profile normal-mode
Enter configuration commands, one per line. End with CNTL/Z.
switch(config-mm-profile)# fabricpath domain default
switch(config-mm-profile-fabricpath-isis)# no set-overload-bit always
switch(config-mm-profile-fabricpath-isis)# end
Exit maintenance profile mode.
switch#
switch# show maintenance profile
[Normal Mode]
fabricpath domain default no
 set-overload-bit always
[Maintenance Mode]
fabricpath domain default
set-overload-bit always

```

This example shows how to create custom maintenance mode and normal mode profiles for a virtual Port Channel (vPC):

```

switch# configure maintenance profile maintenance-mode Enter
configuration commands, one per line. End with CNTL/Z.
switch(config-mm-profile)# vpc domain 1
switch(config-mm-profile-vpc-domain)# shutdown
switch(config-mm-profile-vpc-domain)# exit
switch(config-mm-profile)# system interface shutdown
switch(config-mm-profile)# end
Exit maintenance profile mode.
switch#
switch# configure maintenance profile normal-mode
Enter configuration commands, one per line. End with CNTL/Z.
switch(config-mm-profile)# vpc domain 1
switch(config-mm-profile-vpc-domain)# no shutdown
switch(config-mm-profile-vpc-domain)# exit
switch(config-mm-profile)# no system interface shutdown
switch(config-mm-profile)# end
Exit maintenance profile mode.
switch#
switch# show maintenance profile
[Normal Mode]
vpc domain 1 no
 shutdown
no system interface shutdown
[Maintenance Mode]
vpc domain 1
 shutdown
system interface shutdown

```

This example shows the configuration to be used when there are port-channel or regular L2 ethernet interfaces (except vPC peer link) which carry vPC VLAN traffic and when the corresponding Switch Virtual Interface (SVI) state should not be controlled by these interfaces:

```

Port-channel configuration
switch(config)# interface port-channel3
switch(config-if)# description "L2-Cross Link eth3/3 eth4/3 eth5/3 eth6/3"
switch(config-if)# switchport
switch(config-if)# switchport mode trunk
switch(config-if)# switchport trunk allowed vlan 1101-1500
switch(config-if)# spanning-tree port type network
switch(config-if)# lacp min-links 2
switch(config-if)# switchport autostate exclude vlan 1101-1500
L2 Ethernet configuration
switch(config)# interface ethernet 3/3
switch(config-if)# switchport
switch(config-if)# switchport mode trunk
switch(config-if)# switchport trunk allowed vlan 1101-1500
switch(config-if)# switchport autostate exclude vlan 1101-1500

```

The "redistribute direct" configuration under Border Gateway Protocol (BGP) will attract traffic as the BGP isolate mode does not withdraw direct routes. This example shows how to use the route-map command to enable BGP to withdraw direct routes in isolate mode:

### Policy Configuration

Use route-map my-rmap-deny in maintenance mode configuration to exclude SVIs having tag 200 configuration.

```

switch(config)# route-map my-rmap-deny deny 10
switch(config-route-map)# match tag 200
switch(config-route-map)# exit
switch(config)# route-map my-rmap-deny permit 20

```

Use route-map my-rmap-permit in normal mode configuration to include SVIs having tag 200 configuration.

```

switch(config)# route-map my-rmap-permit permit 10
switch(config-route-map)# match tag 200
switch(config-route-map)# exit
switch(config)# route-map my-rmap-permit permit 20

```

### Virtual IP (vIP)/ Switch Virtual Interface (SVI) configuration

```

switch(config)# interface loopback 200
switch(config-if)# ip address 192.0.2.100/8 tag 200
switch(config)# interface vlan 2
switch(config-if)# ip address 192.0.2.108/8 tag 200
....
switch(config)# interface vlan 3
switch(config-if)# ip address 192.0.2.102/8 tag 200

```

### BGP configuration

```

switch(config)# feature bgp
switch(config)# router bgp 100
switch(config-router)# neighbor 192.0.2.100
....

```

### Maintenance mode profile

```

switch# configure maintenance profile maintenance-mode
switch(config-mm-profile)# router bgp 200
switch(config-mm-profile-router)# address-family ipv4 unicast
switch(config-mm-profile-router-af)# redistribute direct route-map my-rmap-deny
switch(config-mm-profile-router-af)# exit

```

```
switch(config-mm-profile)# sleep instance 1 10
```

### Normal mode profile

```
switch# configure maintenance profile normal-mode
switch(config-mm-profile)# router bgp 100
switch(config-mm-profile-router)# address-family ipv4 unicast
switch(config-mm-profile-router-af)# redistribute direct route-map my-rmap-permit
switch(config-mm-profile-router-af)# exit
switch(config-mm-profile)# sleep instance 1 20
```

## 20.11 Verifying GIR

Use the following commands to verify the configuration:

| Command                                                                                           | Purpose                                                                                                                                                                                                                                                                                 |
|---------------------------------------------------------------------------------------------------|-----------------------------------------------------------------------------------------------------------------------------------------------------------------------------------------------------------------------------------------------------------------------------------------|
| <b>show interface brief</b>                                                                       | Displays abbreviated interface information.                                                                                                                                                                                                                                             |
| <b>show maintenance on-reload reset-reason</b>                                                    | Displays the reset reasons for which the switch comes up in maintenance mode.                                                                                                                                                                                                           |
| <b>show maintenance profile [maintenance-mode   normal-mode]</b>                                  | Displays the details of the maintenance mode or normal mode profile.                                                                                                                                                                                                                    |
| <b>show maintenance snapshot-delay</b>                                                            | Displays the after_maintenance snapshot-delay timer value.                                                                                                                                                                                                                              |
| <b>show maintenance timeout</b>                                                                   | Displays the maintenance mode timeout period, after which the switch automatically returns to normal mode.                                                                                                                                                                              |
| <b>show tech-support mmode</b>                                                                    | Displays maintenance mode information for Inspur technical support.                                                                                                                                                                                                                     |
| <b>show {running--config   startup--config} mmode [all]</b>                                       | Displays the maintenance-mode section of the running or startup configuration. The <b>all</b> option includes the default values.                                                                                                                                                       |
| <b>show snapshots</b>                                                                             | Displays snapshots present on the switch.                                                                                                                                                                                                                                               |
| <b>show snapshots compare snapshot-name-1 snapshot-name-2 [summary   ipv4routes   ipv6routes]</b> | Displays a comparison of two snapshots. The <b>summary</b> option displays just enough information to see the overall changes between the two snapshots. The <b>ipv4routes</b> and the <b>ipv6routes</b> options display the changes in IPv4 and IPv6 routes between the two snapshots. |
| <b>show snapshots dump snapshot-name</b>                                                          | Displays content of the various sections in a generated snapshot.                                                                                                                                                                                                                       |
| <b>show snapshots sections</b>                                                                    | Displays the user-specified snapshot sections.                                                                                                                                                                                                                                          |
| <b>show system mode</b>                                                                           | Displays the current system mode. This command also displays the current state of the maintenance mode timer when the switch is in maintenance mode.                                                                                                                                    |

### 20.11.1 Verifying GIR at Protocol Level

#### BGP (Maintenance mode)

Use the show bgp process command to display BGP status in maintenance mode:

```
switch# show bgp process
BGP Process Information
BGP Process ID : 11725
BGP Protocol Started, reason: : configuration
```



```

BGP Protocol Tag : 100
BGP Protocol State : Running (Isolate)
BGP MMODE : Initialized
BGP Memory State : OK
BGP asformat : asplain
BGP attributes information
Number of attribute entries : 1
HWM of attribute entries : 1
Bytes used by entries : 100
Entries pending delete : 0
HWM of entries pending delete : 0
BGP paths per attribute HWM : 3
BGP AS path entries : 0
Bytes used by AS path entries : 0

```

Use the `show bgp internal all statistics` command to display the number of BGP IPv4 and IPv6 prefixes that have been programmed and also the number of BGP IPv4 and IPv6 prefixes that have not been programmed:

```

BGP internal statistics information for VRF default, address family IPv4 Unicast
 Total prefixes in BGP Table: 3
 Total prefixes pending programming in HW: 0
BGP internal statistics information for VRF default, address family IPv6 Unicast
 Total prefixes in BGP Table: 0
 Total prefixes pending programming in HW: 0

```

### EIGRP (Maintenance mode)

Use the `show ip eigrp` command to display EIGRP status in maintenance mode:

```

switch# show ip eigrp
IP-EIGRP AS 100 ID 30.1.1.1 VRF default
 Process-tag: 100
 Instance Number: 1 Status:
 running (isolate)
 Authentication mode: none
 Authentication key-chain: none
 Metric weights: K1=1 K2=0 K3=1 K4=0 K5=0
 IP proto: 88 Multicast group: 224.0.0.10
 Int distance: 90 Ext distance: 170
 Max paths: 8
 Number of EIGRP interfaces: 1 (0 loopbacks)
 Number of EIGRP passive interfaces: 0
 Number of EIGRP peers: 1
 Redistributing:
 direct route-map passall
 static route-map passall
 Graceful-Restart: Enabled Stub-Routing: Disabled
 NSF converge time limit/expiries: 120/0
 NSF route-hold time limit/expiries: 240/6
 NSF signal time limit/expiries: 20/0
 Redistributed max-prefix: Disabled
 MMODE: Initialized
 Suppress-FIB-Pending Configured

```

### ISIS (Maintenance mode)

Use the `show isis protocol` command to display ISIS status in maintenance mode:

```

switch# show isis protocol
ISIS process : 100
 Instance number : 1 UUID:
 1090519320
 Process ID 6969
 VRF: default
 System ID : 0300.0000.0004 IS-Type : L2

```

```

SAP : 412 Queue Handle : 16
Maximum LSP MTU: 1492 Stateful
HA enabled
Graceful Restart enabled. State: Inactive
Last graceful restart status : none Start-
Mode Complete
BFD IPv4 is globally disabled for ISIS process: 100
BFD IPv6 is globally disabled for ISIS process: 100
Topology-mode is base
Metric-style : advertise(wide), accept(narrow, wide)
Area address(es) :
 10
Process is up and running (isolate)
VRF ID: 1
Stale routes during non-graceful controlled restart
Interfaces supported by IS-IS :
Ethernet1/2

```

### OSPF (Maintenance mode)

Use the show ip ospf internal command to display OSPF status in maintenance mode:

```

switch# show ip ospf internal
ospf 100
ospf process tag 100
ospf process instance number 1
ospf process uuid 1090519321 ospf
process linux pid 6968
ospf process state running (isolate)
System uptime 6d06h
SUP uptime 2 6d06h
Server up : L3VM|IFMGR|RPM|AM|CLIS|URIB|U6RIB|IP|IPv6|SNMP|MMODE
Server required : L3VM|IFMGR|RPM|AM|CLIS|URIB|IP|SNMP Server
registered: L3VM|IFMGR|RPM|AM|CLIS|URIB|IP|SNMP|MMODE Server
optional : MMODE
Early hello : OFF Force
write PSS: FALSE OSPF mts
pkt sap 324 OSPF mts base
sap 320

```

## 20.12 Feature History for GIR

The table below summarizes the new and changed features for this document and shows the releases in which each feature is supported. Your software release might not support all the features in this document. For the latest caveats and feature information, the release notes for your software release.

| Feature Name                                      | Release     | Information                                                                                                                                                                                                                                                                         |
|---------------------------------------------------|-------------|-------------------------------------------------------------------------------------------------------------------------------------------------------------------------------------------------------------------------------------------------------------------------------------|
| Graceful Insertion and Removal (GIR) Enhancements | 8.0(1)      | Support for Simple Network Management Protocol (SNMP) traps and snapshot delay. A CLI indicator to show that the switch is in maintenance mode. The following keywords were added to the <b>system mode maintenance</b> command: <b>non-interactive</b> and <b>snapshot-delay</b> . |
| Graceful Insertion and Removal (GIR)              | 7.3(0)D1(1) | The default mode for GIR is “isolate”. Support for Unplanned Maintenance, Maintenance Mode timer, Suppress FIB Pending, Adding Show commands to snapshots and dumping snapshot sections.                                                                                            |
| Graceful Insertion and Removal (GIR)              | 7.2(0)D1(1) | This feature was introduced.                                                                                                                                                                                                                                                        |

## CHAPTER 21 Configuring iCAM

This chapter includes the following sections:

- Feature History for iCAM
- Information About iCAM
- Licensing Requirements for iCAM
- Default Settings for iCAM
- Enabling iCAM
- Enabling iCAM Monitoring on Resources and Traffic
- Configuring iCAM Monitoring
- Configuring Scale Monitoring
- Displaying Current, Historical, and Predictive Traffic Analytics of TCAM Entries
- Displaying Current, Historical, and Predictive TCAM Resource Usage per Feature
- Explanation of the Display Outputs
- Example: iCAM CLI Outputs
- Example: Obtaining JSON Outputs for iCAM Configurations
- Additional References for iCAM

### 21.1 Feature History for iCAM

This table lists the release history for this feature.

Table 39 Feature History for iCAM

| Feature Name                             | Releases | Feature Information                                                                                                                                                                                                                                          |
|------------------------------------------|----------|--------------------------------------------------------------------------------------------------------------------------------------------------------------------------------------------------------------------------------------------------------------|
| Scale Monitoring                         | 8.4(1)   | Scale monitoring has been expanded to cover the following technology groups: BFD, FEX, FabricPath, Interfaces, Layer 2 Switching, Multicast Routing, NetFlow, OTV, PTP, PVLAN, QoS, Security, SPAN, System Management, Unicast Routing, VXLAN EVPN.          |
| Remote Integrated Services Engine (RISE) | 8.4(1)   | Support for the RISE feature has been deprecated.                                                                                                                                                                                                            |
| iCAM Scale Monitoring                    | 8.3(1)   | This feature was introduced.                                                                                                                                                                                                                                 |
| iCAM TCAM Monitoring                     | 8.2(1)   | <ul style="list-style-type: none"> <li>• Added the requirement for ENHANCED_LAYER2_PKG license.</li> <li>• Added the functionality to enable iCAM monitoring, viewing the history of traffic analytics, and predicting the traffic analytics.</li> </ul>     |
| iCAM                                     | 8.0(1)   | <p>This feature was introduced. The following commands were introduced:</p> <ul style="list-style-type: none"> <li>• <b>feature iCAM</b></li> <li>• <b>show iCAM {entries   resource} module <i>module-number</i> inst <i>instance-number</i></b></li> </ul> |

### 21.2 Information About iCAM

From Inspur INOS Release 8.0(1), the Intelligent CAM (iCAM) analytics and machine-learning feature is supported on Inspur CN12700 Series Switches. The iCAM feature enables you to view the traffic analytics per feature, Ternary Content-Addressable Memory (TCAM) resources and ability to monitor network scale parameters. Before the iCAM feature, it was difficult to get information about the traffic flow through various subnets and applications and an overall view of how many TCAM or Static Random Access Memory (SRAM) resource entries were used or free with various features.

For example, the resource entries utilized in the ACL Classification TCAM per feature, like Router-ACL (RACL), Vlan-ACL (VACL), Port-ACL (PACL), Policy Based Routing (PBR), QoS (Quality of Service), NAT, Intelligent Traffic Director (ITD), Web Cache Communication Protocol (WCCP), or Remote Integrated Services Engine (RISE), could not be determined. Some features might use bulk of the TCAM resources, and some of those TCAM entries might not be in use.

To overcome these limitations, the iCAM feature provides analytics related to network traffic, TCAM usage per feature, detailed analysis per TCAM bank. This helps in effectively utilizing the available TCAM space.

An iCAM process runs on the Supervisor module. It interacts with various components on the line card and collects the hardware resource utilization statistics, performs data processing, and presents a summarized output. It also provides insights about the top hitters and bottom hitters for each feature, like ACL and PBR entries. Using iCAM, you can get packet counts per TCAM entry, sort and search through these entries, and get the top or bottom specified percentage of entries. The traffic analytics helps in better utilization of TCAM space, and better understanding of network traffic.

The iCAM is a VDC global process; it can be enabled only on the default VDC.

The iCAM does not require additional hardware or software. It provides useful traffic telemetry and analytics. iCAM enables you to perform the following:

- View traffic and usage analytics per supported function, Ternary Content-Addressable Memory (TCAM) resources, and TCAM entries.
- Allows you to plan better by understanding the Ternary Content-Addressable Memory (TCAM) usage per feature, enabling you to use TCAM space effectively.
- Verify, detect, plan, and predict your environment against Inspur-verified scale numbers for the different supported functions (Layer 2 switching, unicast routing, multicast routing, and VXLAN).
- Maintain historical usage, functional scale analytics of different supported functions, including entries and resource usage of FIB and ACL TCAM.
- Predict scale (usage level) monitoring for different supported functions in addition to predicted scale for ACL and FIB TCAM entries.
- View health monitoring data (such as CPU, memory, power supply) and information on Intelligent Traffic Director (ITD) services.

### 21.2.1 Overview of iCAM Monitoring

From Inspur INOS Release 8.2(1), you can use iCAM in an IPv4 network to view the traffic analytics based on the type of TCAM entries and the type of TCAM resources. You can set a global monitoring interval to determine how often iCAM should collect data for statistics. You can also set a global interval history, which determines the number of intervals for which iCAM should store statistics.

Based on a default or user-configured scale level threshold on a per-function basis, iCAM generates alerts through system logging messages generation to notify network administrators.

You can obtain traffic and scale (usage level) monitoring for the following resources and functions:

- ACL TCAM entries
- IPv4 multicast TCAM entries
- ACL TCAM resource utilization
- Forward information base (FIB) TCAM resource utilization
- BFD

- FEX
- FabricPath
- Interfaces
- Layer 2 Switching
- Multicast Routing
- NetFlow
- OTV
- PTP
- PVLAN
- QoS
- Security
- SPAN
- System Management
- Unicast Routing
- VXLAN

## 21.2.2 Overview of Scale Monitoring

iCAM scale monitoring provides you the ability to verify, detect, plan, and predict your environment against Inspur verified scale numbers. You can configure all scale monitoring features with default limits and thresholds or customize the threshold values to your specific needs.

Scale monitoring capabilities include:

- Track system scale limits in comparison to Inspur verified limits.
- Two-hour polling interval by default, configurable to one-hour.
- Track average and peak utilizations, along with timestamps for peak utilizations.
- User-configurable scale limits and alert thresholds.
- JSON/XML compatible for off box Orchestrator interaction.
- Per-ASIC instance and Per-VDC Awareness.
- Event-history support.
- Scale predictability - Planning via a centralized data base for historical data.

From Inspur INOS Release 8.4(1), Scale Monitoring supports the following features:

- BFD
- FEX
- FabricPath
- vPC FEX
- Interfaces—BFD, Port-channel, vPC, GRE, Sub-interfaces
- Layer 2 Switching—Layer 2 infrastructure, Spanning Tree Protocol
- Multicast Routing
- OTV
- PVLAN
- QoS
- Security—ACLs, DHCP, UDP Relay
- System Management—SPAN, ERSPAN, PTP, NetFlow
- Unicast Routing—OSPF
- VXLAN

### 21.2.3 Historical Analytics Using iCAM

From Inspur INOS Release 8.2(1), you can use iCAM to obtain the historical traffic analytics of entries and resources. When iCAM monitoring is enabled for resources and entries, the traffic data is periodically polled and stored in the iCAM database. The history option for iCAM entries displays the cumulative traffic stats and average packets per second. The history option for TCAM resources displays the snapshots of TCAM statistics of the past.

The following figure shows the historical traffic data:

Figure 9 Historical Traffic Data

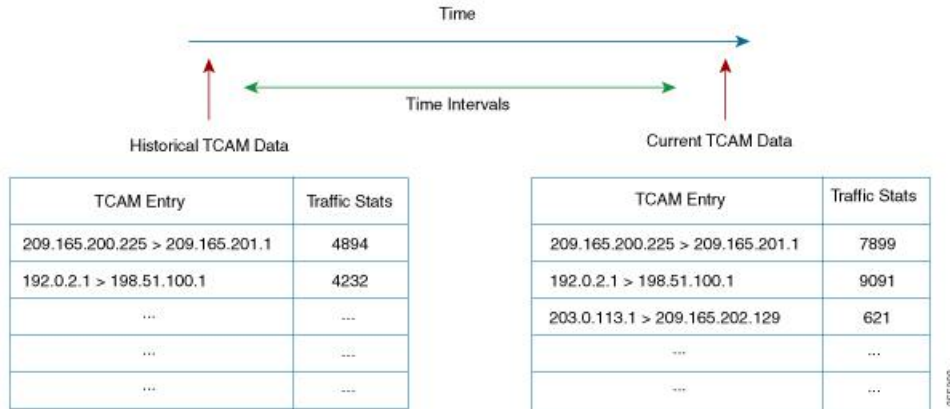

The following figure shows the historical resource utilization:

Figure 10 Historical Resource Utilization

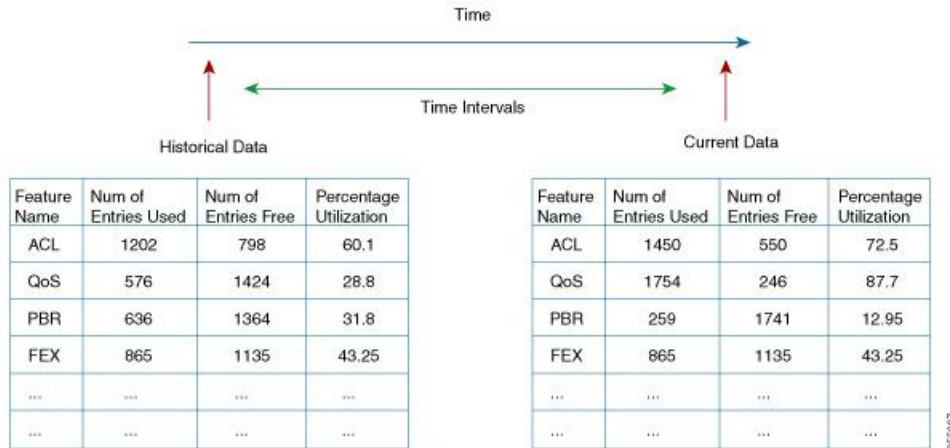

### 21.2.4 Predicting Traffic Analytics Using iCAM

From Inspur INOS Release 8.2(1), you can use iCAM to predict the traffic on entries and resources for a future date. The predictions are based on the data history collected by iCAM. When iCAM monitoring is enabled for resources and entries, the traffic data is periodically polled and stored in the iCAM database. The iCAM feature uses machine-learning algorithms to analyze the historical data and predicts the TCAM usage for a future date and time.

The following figure shows the predicted traffic data:

Figure 11 Predicted Traffic Data

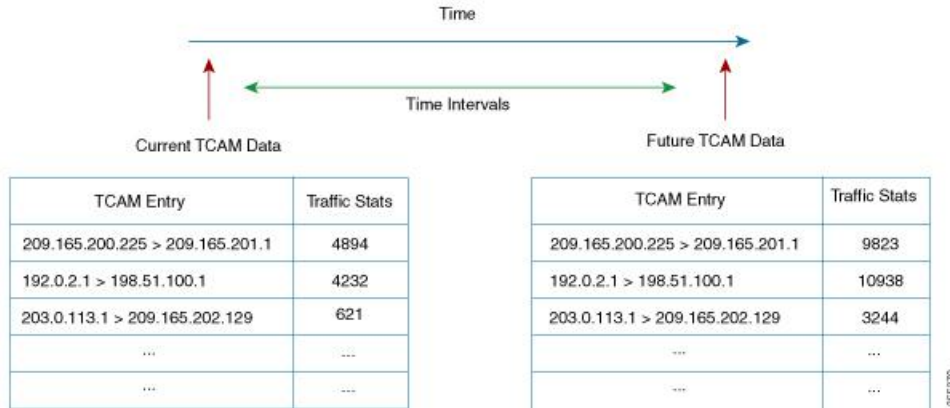

The following figure shows the predicted resource utilization:

Figure 12 Predicted Resource Utilization

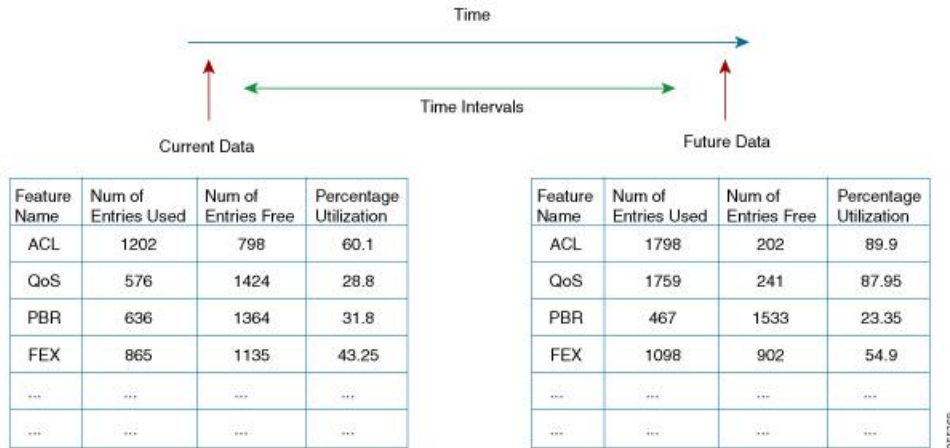

### 21.2.5 Benefits of iCAM

- Allows users to obtain application traffic analytics, like the HTTP traffic and the traffic consumed by an IP or subnet.
- Does not require additional hardware or software.
- Users can get the iCAM analytics and machine-learning feature by upgrading the Inspur INOS software.
- Allows users to plan better by understanding the Ternary Content-Addressable Memory (TCAM) usage per feature.

### 21.3 Licensing Requirements for iCAM

The following table shows the licensing requirements for this feature:

Table 40 Licensing Requirements for iCAM

| Product     | License Requirement                                                            |
|-------------|--------------------------------------------------------------------------------|
| Inspur INOS | From Inspur INOS Release 8.2(1), iCAM requires an ENHANCED_LAYER2_PKG license. |

## 21.4 Default Settings for iCAM

This table lists the default settings for iCAM.

Table 41 Default iCAM Settings

| Parameter                                   | Default                        |
|---------------------------------------------|--------------------------------|
| iCAM                                        | Disabled                       |
| iCAM monitor interval                       | 1                              |
| iCAM interval duration                      | 7200 sec                       |
| Number of intervals in iCAM monitor history | 168 (2 weeks)                  |
| Filter                                      | All the features are displayed |
| Sort order                                  | Descending                     |
| Percentage of entries displayed             | 1                              |

## 21.5 Enabling iCAM

### Procedure

- 
- Step 1** Enter global configuration mode:
- ```
switch# configure terminal
```
- Step 2** Enable the iCAM feature on the device:
- ```
switch(config)# feature icam
```
- The **no** form of this command disables the iCAM feature.
- Step 3** Exit the global configuration mode:
- ```
switch(config)# exit
```
-

Example: Configuring iCAM

This running configuration example shows how to configure the iCAM feature.

```
configure terminal
feature icam
exit
```

21.6 Enabling iCAM Monitoring on Resources and Traffic

Before you begin

Ensure that you have enabled the iCAM feature on the device.

Procedure

-
- Step 1** Enter global configuration mode:
- ```
switch# configure terminal
```
- Step 2** Enable monitoring on the required entries and resources:



- Enable monitoring on the TCAM entries:  
`switch(config)# icam monitor entries acl module module inst instance`
- Enable monitoring on the multicast entries:  
`switch(config)# icam monitor entries multicast module module`
- Enable monitoring on the ACL TCAM resources:  
`switch(config)# icam monitor resource acl-tcam module module inst instance`
- Enable monitoring on the FIB TCAM resources:  
`switch(config)# icam monitor resource fib-tcam module module inst instance`

Use the **no** form of these commands to disable monitoring on the corresponding resources or entries.

**Step 3** Exit the global configuration mode:

```
switch(config)# exit
```

---

### Example: Enabling iCAM Monitoring on Resources and Entries

This running configuration example shows how to enable iCAM monitoring on the TCAM entries. Replace the <placeholders> with relevant values for your setup.

```
configure terminal
 icam monitor entries acl module <3> inst <4>
exit
```

This running configuration example shows how to enable iCAM monitoring for the multicast entries. Replace the <placeholders> with relevant values for your setup.

```
configure terminal
 icam monitor entries multicast module <3>
exit
```

This running configuration example shows how to enable iCAM monitoring on the ACL TCAM resources. Replace the <placeholders> with relevant values for your setup.

```
configure terminal
 icam monitor resource acl-tcam module <3> inst <5>
exit
```

This running configuration example shows how to enable iCAM monitoring on the FIB TCAM resources. Replace the <placeholders> with relevant values for your setup.

```
configure terminal
 icam monitor resource fib-tcam module <3> inst <5>
exit
```

## 21.7 Configuring iCAM Monitoring

### Before you begin

Ensure that you have enabled the iCAM feature on a device.

### Procedure

**Step 1** Enter global configuration mode:

```
switch# configure terminal
```

**Step 2** Set the iCAM monitor interval and the global interval history:

```
switch(config)# icam monitor interval interval-hours num_intervals num-intervals
```

Use the **no** form of this command to reset to the default values. The default value of the global monitoring interval is 2 hours and the default value of the interval history is 168. The default values might change when more data is collected on the accuracy of machine-learning.

**Step 3** Exit the global configuration mode:

```
switch(config)# exit
```

### Example: Configuring iCAM Monitor Interval

This running configuration example shows how to set the iCAM monitor interval and the global interval history. Replace the <placeholders> with relevant values for your setup.

```
configure terminal
icam monitor interval <2> num_intervals <90>
exit
```

## 21.8 Configuring Scale Monitoring

### Procedure

**Step 1** Enter global configuration mode:

```
switch# configure terminal
```

**Step 2** Enable the iCAM feature. The **no** form of this command disables the iCAM feature.

```
switch(config)# feature icam
```

You must enable iCAM monitoring if you want to configure and record history and predict TCAM entries or resources.

**Step 3** Enable all features with default limits and thresholds.

```
switch(config)# [no]icammonitorscale
```

**Step 4** Enables you to customize the limit for a specific BFD feature to override its default limit. Feature limit range is 1 to 4294967295 for this step and for the following 4-18 steps with **icam monitor scale feature** form.

**Note:** The **icam monitor scale<technology> <feature>limit val** command does not enable scale monitoring for this feature but only configures scale limit for the feature.

```
switch(config)# [no]icam monitor scale bfd {mh-sess | sess | sess-15x3 | sess-300x3 | sess-50x3 | sess-subintf} limit new feature limit
```

**Step 5** Enables you to customize the limit for a specific fabricpath feature to override its default limit. Feature limit range is 1 to 4294967295.

```
switch(config)# [no]icam monitor scale fabricpath {mcast-group | switch-id | vlan} limit new feature limit
```

- Step 6** Enables you to customize the limit for a specific FEX feature to override its default limit. Feature limit range is 1 to 4294967295.
- ```
switch(config)# [no]icam monitor scale fex { actv-actv | fex-count | interfaces }limit new feature limit
```
- Step 7** Enables you to customize the limit for a specific interface feature to override its default limit. Feature limit range is 1 to 4294967295.
- ```
switch(config)# [no]icam monitor scale interface {gre tunnel | port-channel port-channel-count | subinterf subinterf-count | vpc { fcoe | fex | vpc-count | vpcplus} }limit new feature limit
```
- Step 8** Enables you to customize the limit for a specific Layer 2 switching feature to override its default limit. Feature limit range is 1 to 4294967295..
- ```
switch(config)# [no]icam monitor scale 12-switching {infra | stp {mst-instance | mst-vport | rpvst-lport | rpvst-vport} | vlan vlan-count }limit new feature limit
```
- Step 9** Enables you to customize the limit for a specific multicast routing feature to override its default limit. Feature limit range is 1 to 4294967295.
- ```
switch(config)# [no]icam monitor scale multicast-routing {igmp group | pim neighbor | routing-forwarding route-v4 }limit new feature limit
```
- Step 10** Enables you to customize the limit for a specific netflow feature to override its default limit. Feature limit range is 1 to 4294967295.
- ```
switch(config)# [no]icam monitor scale netflow ppslimit new feature limit
```
- Step 11** Enables you to customize the limit for a specific OTV feature to override its default limit. Feature limit range is 1 to 4294967295.
- ```
switch(config)# [no]icam monitor scale otv {datagroup | localmroute | overlay | vlan }limit new feature limit
```
- Step 12** Enables you to customize the limit for a specific PTP feature to override its default limit. Feature limit range is 1 to 4294967295.
- ```
switch(config)# [no]icam monitor scale ptp num-clients limit new feature limit
```
- Step 13** Enables you to customize the limit for a specific PVLAN feature to override its default limit. Feature limit range is 1 to 4294967295.
- ```
switch(config)# [no]icam monitor scale pvlan {host-ports | isol-trunk-ports | primary-vlans | prom-ports | prom-trunk-ports | secondary-vlans }limit new feature limit
```
- Step 14** Enables you to customize the limit for a specific QoS feature to override its default limit. Feature limit range is 1 to 4294967295.
- ```
switch(config)# [no]icam monitor scale qos {classmaps | policers }limit new feature limit
```
- Step 15** Enables you to customize the limit for a specific security feature to override its default limit. Feature limit range is 1 to 4294967295.
- ```
switch(config)# [no]icam monitor scale security {acl {ace | acl-count | infs-applied | l4op-label | non-l4op-label } | cts {ip-sgt-mappings-using-sxp | sxp-connection} | dhcp {relay-agent | snoop-binding | snoop-vlan} | udp-relay {obj | port} }limit new feature limit
```
- Step 16** Enables you to customize the limit for a specific SPAN feature to override its default limit. Feature limit range is 1 to 4294967295.

- Step 17** `switch(config)# [no]icam monitor scale span {erspan-dst-sess | extended-sess }limit new feature limit`  
 Enables you to customize the limit for a specific unicast routing feature to override its default limit. Feature limit range is 1 to 4294967295.
- Step 18** `switch(config)# [no]icam monitor scale unicast-routing ospf {area | lsa | nbr | passive-intf | vrf }limit new feature limit`  
 Enables you to customize the limit for a specific VXLAN feature to override its default limit. Feature limit range is 1 to 4294967295..
- Step 19** `switch(config)# [no]icam monitor scale vxlan {bd | encap-prof | mac | vni | vsi-intf }limit new feature limit`  
 (Optional) Specify the iCAM monitor interval limits.
- Step 20** `switch(config)# [no]icammonitorintervalinterval-hoursnum_intervalsnumber-of-intervals`  
 (Optional) Specify the iCAM change percent threshold limits.
- interval-hours— iCAM monitor interval in hours. The range is 1 to 24 hours.
  - number-of-intervals— iCAM monitor history. The range is 168 to 1344.
- Step 21** `switch(config)# [no]icammonitorscalethreshold infoinfo-threshold-percentwarningwarning-threshold-percentcriticalcritical-threshold-percent`  
 (Optional) Specify the iCAM change percent threshold limits.
- info—Configures the info threshold. The range is 1 to 100 percent, default value is 80 percent.
  - warning—Configures the warning threshold. The range is 1 to 100 percent, default value is 90 percent.
  - critical—Configures the critical threshold. The range is 1 to 100 percent, default value is 100 percent.
- Step 22** `switch(config)# exit`  
 (Optional) Exits the global configuration mode.
- Step 23** `switch# showicamscale`  
 (Optional) Display data from the default scale monitoring thresholds.
- Verified Scale—CCO QA verified scale numbers that are based on software version and hardware.
  - Customer Configured Scale—Displays the difference between configured and verified.
  - Threshold Exceeded —Displays the highest threshold level exceeded.
- Step 24** `switch# showicamscaleutilization`  
 (Optional) Display the utilization data including average and peak utilization data, peak timestamp, 7-day totals, and total counts.
- Step 25** `switch# showicamscalethresholds`  
 (Optional) Display the hit count and the last timestamp of the exceeding configured scale for each configured threshold. Use the hit count for each threshold to determine if the event is an anomaly or frequently occurring. The Last Info Exceeded Timestamp displays the last timestamp of the exceeding configured scale.
- `switch# showicamscale historynumber of intervalssort{current-scale {ascending | descending}}`  
 (Optional) Display the scale history and sort the history records by the current scale value or by the polled time stamp.

- Step 26**      `polled-timestamp {newest | oldest}`  
 Display the BFD data. You can customize the display of BFD data. Use ? to display a list of supported BFD keywords.
- Step 27**      `switch# show icam scale bfd`  
 Display the fabricpath data. You can customize the display of fabricpath data. Use ? to display a list of supported fabricpath keywords.
- Step 28**      `switch# show icam scale fabricpath`  
 Display the fabric extender data. You can customize the display of FEX data. Use ? to display a list of supported FEX keywords.
- Step 29**      `switch# show icam scale fex`  
 Display the interface data. You can customize the display of interface data. Use ? to display a list of supported interface keywords.
- Step 30**      `switch# show icam scale interface`  
 Display the Layer 2 switching data. You can customize the display of Layer 2 switching data. Use ? to display a list of supported Layer 2 switching keywords.
- Step 31**      `switch# show icam scale l2-switching`  
 Display the multicast routing data. You can customize the display of multicast routing data. Use ? to display a list of supported multicast routing keywords.
- Step 32**      `switch# show icam scale multicast-routing`  
 Display the netflow data. You can customize the display of netflow data. Use ? to display a list of supported netflow keywords.
- Step 33**      `switch# show icam scale netflow`  
 Display the OTV data. You can customize the display of OTV data. Use ? to display a list of supported OTV keywords.
- Step 34**      `switch# show icam scale otv`  
 Display the PTP data. You can customize the display of PTP data. Use ? to display a list of supported PTP keywords.
- Step 35**      `switch# show icam scale ptp`  
 Display the PVLAN data. Use ? to display a list of supported PVLAN keywords.
- Step 36**      `switch# show icam scale pvlan`  
 Display the QoS data. Use ? to display a list of supported QoS keywords.
- Step 37**      `switch# show icam scale qos`  
 Display the security data. Use ? to display a list of supported security keywords.
- Step 38**      `switch# show icam scale security`  
 Display the SPAN data. Use ? to display a list of supported SPAN keywords.
- Step 39**      `switch# show icam scale span`  
 Display the unicast routing data. Use ? to display a list of supported unicast routing keywords.
- Step 40**      `switch# show icam scale unicast-routing`  
 Display the VXLAN data. Use ? to display a list of supported VXLAN keywords.
- Step 41**      `switch# show icam scale vxlan`  
 Displays the traffic prediction of scale monitoring.
- Step 41**      `switch# show icam prediction scale year month day time`  
 • year—Specifies the year in the YYYY format. The values range from 1970 to 2030.

- month—Specifies the month as Jan, Feb, or so on. The values are case sensitive.
- day—Specifies the day of the month in the DD format. The values range from 1 to 31.
- time—Specifies the time in the HH:MM:SS format.

**Example: Verifying Scale Monitoring**

The following examples display sample data from PVLAN scale monitoring with the associated keywords.

```
switch# show icam scale pvlan
Retrieving data. This may take some time ...
=====
Info Threshold = 80 percent (default) |
Warning Threshold = 90 percent (default) | Critical
Threshold = 100 percent (default) | All
timestamps are in UTC |
=====
```

-----  
 Scale Limits for PVLAN  
 -----

| Feature          | Verified | Polled Timestamp        |          | Cur       | Cur | Threshold | Scale      | Scale | Scale | Util       |
|------------------|----------|-------------------------|----------|-----------|-----|-----------|------------|-------|-------|------------|
|                  |          | Config                  | Exceeded |           |     |           |            |       |       |            |
| -----            |          |                         |          |           |     |           |            |       |       |            |
|                  |          | PVLAN Primary VLANs     |          | -         |     | -         |            | -     |       | -          |
|                  |          |                         |          |           |     |           |            |       |       | 21:33:43   |
| (VDC:1)          | 25       | 1                       |          | 151500.00 |     | Critical  | 2019-06-05 |       |       | 21:33:43   |
| (VDC:2)          | 25       | 1                       |          | 1 100.00  |     | Critical  | 2019-06-05 |       |       |            |
|                  |          | PVLAN Secondary VLANs   |          | -         |     | -         |            | -     |       | -          |
|                  |          |                         |          |           |     |           |            |       |       | 21:33:43   |
|                  |          |                         |          |           |     |           |            |       |       | 21:33:43   |
|                  |          |                         |          |           |     |           |            |       |       | - 21:33:43 |
| (VDC:1)          | 75       | 75                      |          | 2 2.66    |     | None      | 2019-06-05 |       |       | 21:33:43   |
| (VDC:2)          | 75       | 75                      |          | 0 0.00    |     | None      | 2019-06-05 |       |       |            |
| PVLAN Host Ports |          |                         |          | -         |     | -         |            |       |       |            |
| (VDC:1)          | 20       | 20                      |          | 0 0.00    |     | None      | 2019-06-05 |       |       |            |
| (VDC:2)          | 20       | 20                      |          | 0 0.00    |     | None      | 2019-06-05 |       |       |            |
|                  |          | PVLAN Promiscuous Ports |          | -         |     | -         |            | -     |       | -          |
|                  |          |                         |          |           |     |           |            |       |       | 21:33:43   |

|         |                          |     |   |      |      |            |          |
|---------|--------------------------|-----|---|------|------|------------|----------|
| (VDC:1) | 16                       | 16  | 0 | 0.00 | None | 2019-06-05 | 21:33:43 |
| (VDC:2) | 16                       | 16  | 0 | 0.00 | None | 2019-06-05 |          |
|         | PVLAN Promisc Trk Ports  |     |   |      |      |            |          |
|         | -                        |     |   |      |      |            |          |
|         | 21:33:43                 |     |   |      |      |            |          |
| (VDC:1) | 150                      | 150 | 0 | 0.00 | None | 2019-06-05 | 21:33:43 |
| (VDC:2) | 150                      | 150 | 0 | 0.00 | None | 2019-06-05 |          |
|         | PVLAN Isolated Trk Ports |     |   |      |      |            |          |
|         | -                        |     |   |      |      |            |          |

|          |         |    |    |   |      |      |            |
|----------|---------|----|----|---|------|------|------------|
| 21:33:43 | (VDC:1) | 30 | 30 | 0 | 0.00 | None | 2019-06-05 |
| 21:33:43 | (VDC:2) | 30 | 30 | 0 | 0.00 | None | 2019-06-05 |

```

switch# show icam scale pvlan thresholds
=====
Info Threshold = 80 percent (default) |
Warning Threshold = 90 percent (default) |
Critical Threshold = 100 percent (default) |
All timestamps are in UTC |
=====

```

-----  
Scale Limits for PVLAN  
-----

| Warning Exceeded | Feature Last Exceeded   | Verified Warning Timestamp | Critical Scale Exceeded | Config Scale | Current Last Exceeded | Info Exceeded | Last Info Exceeded Timestamp |  |
|------------------|-------------------------|----------------------------|-------------------------|--------------|-----------------------|---------------|------------------------------|--|
|                  | PVLAN Primary VLANs     |                            |                         |              |                       |               |                              |  |
|                  | -                       |                            | -                       | -            | -                     | -             | -                            |  |
|                  |                         | (VDC:1) 20:48:19           |                         | 25           | 1                     | 15            | 3 2019-06-05                 |  |
| 3                | 2019-06-05              | 20:48:19                   |                         | 25           | 1                     | 1             | 3 2019-06-05                 |  |
| 3                | 2019-06-05              | 20:48:19                   |                         | 3            | 2019-06-05            | 20:48:19      |                              |  |
|                  | PVLAN Secondary VLANs   |                            |                         |              |                       |               |                              |  |
|                  | -                       |                            | -                       | -            | -                     | -             | -                            |  |
| 0                |                         | (VDC:1)                    | 75                      | 75           | 2                     | 0             | -                            |  |
| 0                |                         | (VDC:2)                    | 75                      | 75           | 0                     | 0             | -                            |  |
|                  | PVLAN Host Ports        |                            |                         |              |                       |               |                              |  |
|                  | -                       |                            | -                       | -            | -                     | -             | -                            |  |
| 0                |                         | (VDC:1)                    | 20                      | 20           | 0                     | 0             | -                            |  |
| 0                |                         | (VDC:2)                    | 20                      | 20           | 0                     | 0             | -                            |  |
|                  | PVLAN Promiscuous Ports |                            |                         |              |                       |               |                              |  |
|                  | -                       |                            | -                       | -            | -                     | -             | -                            |  |
| 0                |                         | (VDC:1)                    | 16                      | 16           | 0                     | 0             | -                            |  |
|                  |                         | (VDC:2)                    | 16                      | 16           | 0                     | 0             | -                            |  |





19:48:18  
 20:48:19  
 18:48:17  
 19:48:18  
 20:48:19

- 18:48:17

19:48:18  
 20:48:19  
 18:48:17  
 19:48:18  
 20:48:19

|                         |    |    |   |      |      |            |
|-------------------------|----|----|---|------|------|------------|
| (VDC:1)                 | 75 | 75 | 2 | 2.66 | None | 2019-06-05 |
|                         |    |    | 2 | 2.66 | None | 2019-06-05 |
|                         |    |    | 2 | 2.66 | None | 2019-06-05 |
| (VDC:2)                 | 75 | 75 | 0 | 0.00 | None | 2019-06-05 |
|                         |    |    | 0 | 0.00 | None | 2019-06-05 |
|                         |    |    | 0 | 0.00 | None | 2019-06-05 |
| PVLAN Host Ports        | -  | -  | - | -    | -    |            |
| (VDC:1)                 | 20 | 20 | 0 | 0.00 | None | 2019-06-05 |
|                         |    |    | 0 | 0.00 | None | 2019-06-05 |
|                         |    |    | 0 | 0.00 | None | 2019-06-05 |
| (VDC:2)                 | 20 | 20 | 0 | 0.00 | None | 2019-06-05 |
|                         |    |    | 0 | 0.00 | None | 2019-06-05 |
|                         |    |    | 0 | 0.00 | None | 2019-06-05 |
| PVLAN Promiscuous Ports |    |    | - |      | -    | -          |

18:48:17  
 19:48:18  
 20:48:19

|         |    |    |   |      |      |            |
|---------|----|----|---|------|------|------------|
| (VDC:1) | 16 | 16 | 0 | 0.00 | None | 2019-06-05 |
|         |    |    | 0 | 0.00 | None | 2019-06-05 |
|         |    |    | 0 | 0.00 | None | 2019-06-05 |
| (VDC:2) | 16 | 16 | 0 | 0.00 | None | 2019-06-05 |

```

18:48:17
19:48:18
20:48:19

0 0.00 None 2019-06-05
0 0.00 None 2019-06-05
PVLAN Promisc Trk Ports - - - -
-

18:48:17
19:48:18
20:48:19
18:48:17
19:48:18
20:48:19
(VDC:1) 150 150 0 0.00 None 2019-06-05
0 0.00 None 2019-06-05
0 0.00 None 2019-06-05
(VDC:2) 150 150 0 0.00 None 2019-06-05
0 0.00 None 2019-06-05
0 0.00 None 2019-06-05
PVLAN Isolated Trk Ports - - - -
-
18:48:17 (VDC:1) 30 30 0 0.00 None 2019-06-05
19:48:18 0 0.00 None 2019-06-05
20:48:19 0 0.00 None 2019-06-05
18:48:17 (VDC:2) 30 30 0 0.00 None 2019-06-05
19:48:18 0 0.00 None 2019-06-05
20:48:19 0 0.00 None 2019-06-05

```

switch# show icam scale pvlan utilization

```

=====
Info Threshold = 80 percent (default) |
Warning Threshold = 90 percent (default) |
Critical Threshold = 100 percent (default) |
All timestamps are in UTC |
=====

```

-----  
Scale Limits for PVLAN  
-----

| 7-Day Peak | Peak | Feature | Verified | Config | Cur | Cur | Avg | 7-Day |
|------------|------|---------|----------|--------|-----|-----|-----|-------|
|            |      |         |          | Peak   |     |     |     |       |

| Timestamp                | Util    | Scale<br>Timestamp  | Scale      | Scale | Util      | Util    | Util          |
|--------------------------|---------|---------------------|------------|-------|-----------|---------|---------------|
| -----                    |         |                     |            |       |           |         |               |
| PVLAN Primary VLANs      |         |                     |            |       |           |         |               |
| -                        | -       | -                   | -          | -     | -         | -       | -             |
|                          |         | (VDC:1)             | 25         | 1     | 151500.00 | 1500.00 | 1500.00       |
| 07:25:46                 | 1500.00 | 2019-06-05 07:25:46 | 2019-06-05 |       |           |         |               |
|                          |         | (VDC:2)             | 25         | 1     | 1         | 100.00  | 100.00 100.00 |
| 07:25:46                 | 100.00  | 2019-06-05 07:25:46 | 2019-06-05 |       |           |         |               |
| PVLAN Secondary VLANs    |         |                     |            |       |           |         |               |
| -                        | -       | -                   | -          | -     | -         | -       | -             |
|                          |         | (VDC:1)             | 75         | 75    | 2         | 2.66    | 2.66 2.66     |
| 07:25:46                 | 2.66    | 2019-06-05 07:25:46 | 2019-06-05 |       |           |         |               |
|                          |         | (VDC:2)             | 75         | 75    | 0         | 0.00    | 0.00 0.00     |
| 07:25:46                 | 0.00    | 2019-06-05 07:25:46 | 2019-06-05 |       |           |         |               |
| PVLAN Host Ports         |         |                     |            |       |           |         |               |
| -                        | -       | -                   | -          | -     | -         | -       | -             |
|                          |         | (VDC:1)             | 20         | 20    | 0         | 0.00    | 0.00 0.00     |
| 07:25:46                 | 0.00    | 2019-06-05 07:25:46 | 2019-06-05 |       |           |         |               |
|                          |         | (VDC:2)             | 20         | 20    | 0         | 0.00    | 0.00 0.00     |
| 07:25:46                 | 0.00    | 2019-06-05 07:25:46 | 2019-06-05 |       |           |         |               |
| PVLAN Promiscuous Ports  |         |                     |            |       |           |         |               |
| -                        | -       | -                   | -          | -     | -         | -       | -             |
|                          |         | (VDC:1)             | 16         | 16    | 0         | 0.00    | 0.00 0.00     |
| 07:25:46                 | 0.00    | 2019-06-05 07:25:46 | 2019-06-05 |       |           |         |               |
|                          |         | (VDC:2)             | 16         | 16    | 0         | 0.00    | 0.00 0.00     |
| 07:25:46                 | 0.00    | 2019-06-05 07:25:46 | 2019-06-05 |       |           |         |               |
| PVLAN Promisc Trk Ports  |         |                     |            |       |           |         |               |
| -                        | -       | -                   | -          | -     | -         | -       | -             |
|                          |         | (VDC:1)             | 150        | 150   | 0         | 0.00    | 0.00 0.00     |
| 07:25:46                 | 0.00    | 2019-06-05 07:25:46 | 2019-06-05 |       |           |         |               |
|                          |         | (VDC:2)             | 150        | 150   | 0         | 0.00    | 0.00 0.00     |
| 07:25:46                 | 0.00    | 2019-06-05 07:25:46 | 2019-06-05 |       |           |         |               |
| PVLAN Isolated Trk Ports |         |                     |            |       |           |         |               |
| -                        | -       | -                   | -          | -     | -         | -       | -             |
|                          |         | (VDC:1)             | 30         | 30    | 0         | 0.00    | 0.00 0.00     |
| 07:25:46                 | 0.00    | 2019-06-05 07:25:46 | 2019-06-05 |       |           |         |               |
|                          |         | (VDC:2)             | 30         | 30    | 0         | 0.00    | 0.00 0.00     |
| 07:25:46                 | 0.00    | 2019-06-05 07:25:46 | 2019-06-05 |       |           |         |               |

## 21.9 Displaying Current, Historical, and Predictive Traffic Analytics of TCAM Entries

The TCAM entries and traffic analytics are listed per module and per TCAM instance. To display the current, historical, or predictive traffic analytics of TCAM entries, use the following commands:

| Command                                                                                                                                                                                                                                                        | Description                                                                                                                                                                                                                                                                                                                                                                                                                                                                                                                                                                                                                                                                                                                                                                                                                                                                                                                                                                                                                                                                                                                                                                                                                                                                                                                                                                                                                                                                    |
|----------------------------------------------------------------------------------------------------------------------------------------------------------------------------------------------------------------------------------------------------------------|--------------------------------------------------------------------------------------------------------------------------------------------------------------------------------------------------------------------------------------------------------------------------------------------------------------------------------------------------------------------------------------------------------------------------------------------------------------------------------------------------------------------------------------------------------------------------------------------------------------------------------------------------------------------------------------------------------------------------------------------------------------------------------------------------------------------------------------------------------------------------------------------------------------------------------------------------------------------------------------------------------------------------------------------------------------------------------------------------------------------------------------------------------------------------------------------------------------------------------------------------------------------------------------------------------------------------------------------------------------------------------------------------------------------------------------------------------------------------------|
| <p><b>show icam entries acl module</b> <i>module inst instance</i> [<b>history</b> <i>num-intervals</i>] [<b>sort</b> {[<b>filter</b> <i>feature-name</i> [<b>exact</b>]}] [<b>sort-order</b> <i>sort-order-list</i>] [<b>top</b> <i>top-percentage</i>];}</p> | <p>Lists TCAM entries based on the options selected.</p> <ul style="list-style-type: none"> <li>• <b>history</b>—Displays the traffic history of entries for the specified number of intervals.</li> <li>• <b>sort</b>—Specifies how to filter or sort the list of TCAM entries. You must use at least one option if you filter TCAM entries using the <b>sort</b> keyword.</li> <li>• <b>filter</b> <i>feature-name</i>—Filters the TCAM entries based on the feature name.</li> </ul> <p><b>Note</b> By default, all the features are displayed. Enclose the feature name in quotation marks if it contains more than one word, like QoS COPP.</p> <ul style="list-style-type: none"> <li>• <b>exact</b>—Filters the TCAM entries based on the exact feature name.</li> </ul> <p><b>Note</b> This keyword can be used only when filtering the TCAM entries by feature names.</p> <ul style="list-style-type: none"> <li>• <b>sort-order</b>—Sorts the entries in either ascending or descending order.</li> </ul> <p><b>Note</b> The valid values are 1 and 2. 1 displays the list in ascending order and 2 displays the list in descending order. The entries are sorted in descending order by default.</p> <ul style="list-style-type: none"> <li>• <b>top</b> <i>top-percentage</i>—Displays the top TCAM entries, sorted by packet count, based on the specified percentage.</li> </ul> <p><b>Note</b> The valid values are from 1 to 100. The default value is 1%.</p> |
| <p><b>show icam entries multicast module</b> <i>module</i> [<b>history</b> <i>num-intervals</i>] [<b>sort</b> {[<b>sort-order</b> <i>sort-order-list</i>] [<b>top</b> <i>top-percentage</i>];}</p>                                                             | <p>Lists the multicast entries per module.</p>                                                                                                                                                                                                                                                                                                                                                                                                                                                                                                                                                                                                                                                                                                                                                                                                                                                                                                                                                                                                                                                                                                                                                                                                                                                                                                                                                                                                                                 |
| <p><b>show icam prediction entries acl module</b> <i>module inst inst year month day time</i> [<b>top</b> <i>top-percentage</i>]</p>                                                                                                                           | <p>Displays the traffic prediction of the TCAM entries.</p> <ul style="list-style-type: none"> <li>• <i>year</i>—Specifies the year in the YYYY format. The values range from 1970 to 2030.</li> <li>• <i>month</i>—Specifies the month as Jan, Feb, or so on.</li> </ul> <p><b>Note</b> The values are case sensitive.</p> <ul style="list-style-type: none"> <li>• <i>day</i>—Specifies the day of the month in the DD format. The values range from 1 to 31.</li> <li>• <i>time</i>—Specifies the time in the HH:MM:SS format.</li> <li>• <b>top</b> <i>top-percentage</i>—Displays the top TCAM entries, sorted by packet count, based on the specified percentage.</li> </ul> <p><b>Note</b> Valid values are from 1 to 10. The default value is 1%.</p>                                                                                                                                                                                                                                                                                                                                                                                                                                                                                                                                                                                                                                                                                                                  |
| <p><b>show icam prediction entries multicast module</b> <i>module year month day time</i> [<b>top</b> <i>top-percentage</i>]</p>                                                                                                                               | <p>Displays the traffic prediction of the multicast entries.</p>                                                                                                                                                                                                                                                                                                                                                                                                                                                                                                                                                                                                                                                                                                                                                                                                                                                                                                                                                                                                                                                                                                                                                                                                                                                                                                                                                                                                               |

You can use the output of the above commands to generate a chord diagram. A chord diagram provides a simple view of complex traffic flows. You can identify an anomalous traffic flow using a chord diagram.

This example shows how to view the top 2% traffic flow of the TCAM entries for a current date.

```

switch# show icam entries acl module 5 inst 0 sort top 2
Retrieving data from linecard. This may take some time ...

=====
TCAM Entries (Mod 5,Inst 0)

```

| Feature    | Pkt_Type   | Source IP/Mask | Dest IP/Mask          | Action         | ifindex                     | Stats  |
|------------|------------|----------------|-----------------------|----------------|-----------------------------|--------|
| RACL       | IPv4       |                | ip 209.165.201.3/27   |                | 209.165.202.131/27          | Permit |
| 0x1a200000 | 1531248034 |                |                       |                |                             |        |
| RACL       | IPv4       |                | ip 209.165.201.2/27   |                | 209.165.202.132/27          | Permit |
| 0x1a200000 | 765624017  |                |                       |                |                             |        |
| RACL       | IPv4       |                | ip 209.165.201.1/27   |                | 209.165.202.134/27          | Permit |
| 0x1a200000 | 765624017  |                |                       |                |                             |        |
| RACL       | IPv4       |                | ip 209.165.201.2/27   |                | 209.165.202.131/27          | Permit |
| 0x1a200000 | 765624017  |                |                       |                |                             |        |
| RACL       | IPv4       |                | ip 209.165.201.1/27   |                | 209.165.202.131/27          | Permit |
| 0x1a200000 | 382812009  |                |                       |                |                             |        |
| RACL       | IPv4       |                |                       | ip 0.0.0.0/0   | 0.0.0.0/0                   | Deny   |
| 0x1a200000 | 241001297  |                |                       |                |                             |        |
| RACL       | IPv4       |                | ip 209.165.201.3/27   |                | 209.165.202.133/27          | Permit |
| 0x1a200000 | 76562402   |                |                       |                |                             |        |
| RACL       | IPv4       |                | ip 209.165.201.1/27   |                | 209.165.202.132/27          | Permit |
| 0x1a200000 | 76562402   |                |                       |                |                             |        |
| RACL       | IPv4       |                | ip 209.165.201.1/27   |                | 209.165.202.133/27          | Permit |
| 0x1a200000 | 76562402   |                |                       |                |                             |        |
| RACL       | IPv4       |                | ip 209.165.201.3/27   |                | 209.165.202.132/27          | Permit |
| 0x1a200000 | 76562402   |                |                       |                |                             |        |
| RACL       | IPv4       |                | ip 209.165.201.8/27   |                | 209.165.202.131/27          | Permit |
| 0x1a200000 | 76562402   |                |                       |                |                             |        |
| RACL       | IPv4       |                | ip 209.165.202.132/27 |                | 209.165.201.2/27            | Permit |
| 0x1a200000 | 48731168   |                |                       |                |                             |        |
| RACL       | IPv4       |                | ip 209.165.202.133/27 |                | 209.165.201.3/27            | Permit |
| 0x1a200000 | 48186974   |                |                       |                |                             |        |
| RACL       | IPv4       |                | ip 209.165.202.131/27 |                | 209.165.201.2/27            | Permit |
| 0x1a200000 | 47334529   |                |                       |                |                             |        |
| QoS        | COPP IPv4  |                | pim 0.0.0.0/0         |                | 209.165.202.135/27          | QoS    |
|            | 0x0        | 17973          |                       |                |                             |        |
| QoS        | COPP IPv4  |                | igmp 0.0.0.0/0        |                | 209.165.202.136/27          | QoS    |
|            | 0x0        | 4319           |                       |                |                             |        |
| QoS        | COPP ARP   | arp-rarp/all   | ip 0.0.0.0/0          | 0.0.0.0/0      | 0000.0000.0000 0000.0000.00 | QoS    |
|            | 0x0        | 15             |                       |                |                             |        |
| QoS        | COPP IPv4  |                |                       | udp 0.0.0.0/0  | 0.0.0.0/0                   | QoS    |
|            | 0x0        | 4              |                       |                |                             |        |
| VACL       | IPv4       |                |                       | icmp 0.0.0.0/0 | 0.0.0.0/0                   | Permit |

|          |   |                                         |
|----------|---|-----------------------------------------|
| 0x0      | 0 |                                         |
| VACLIPv4 |   | udp 0.0.0.0/0 0.0.0.0/0 Permit          |
| 0x0      | 0 |                                         |
| VACLIPv4 |   | tcp 0.0.0.0/0 0.0.0.0/0 Permit          |
| 0x0      | 0 |                                         |
| VACLIPv4 |   | tcp 0.0.0.0/0 0.0.0.0/0 Permit          |
| 0x0      | 0 |                                         |
| VACLIPv4 |   | udp 0.0.0.0/0 0.0.0.0/0 Permit          |
| 0x0      | 0 |                                         |
| VACLIPv4 |   | tcp 209.165.202.137/27 0.0.0.0/0 Permit |
| 0x0      | 0 |                                         |
| VACLIPv4 |   | tcp 209.165.202.137/27 0.0.0.0/0 Permit |
| 0x0      | 0 |                                         |
| VACLIPv4 |   | tcp 209.165.202.137/27 0.0.0.0/0 Permit |
| 0x0      | 0 |                                         |
| VACLIPv4 |   | tcp 209.165.202.137/27 0.0.0.0/0 Permit |
| 0x0      | 0 |                                         |
| VACLIPv4 |   | tcp 209.165.202.137/27 0.0.0.0/0 Permit |
| 0x0      | 0 |                                         |
| VACLIPv4 |   | tcp 209.165.202.137/27 0.0.0.0/0 Permit |
| 0x0      | 0 |                                         |
| VACLIPv4 |   | tcp 209.165.202.137/27 0.0.0.0/0 Permit |

You can use the output in this example to generate a chord diagram. The following figure shows the traffic flow, which is generated using the output in this example:

Figure 13 Chord Diagram

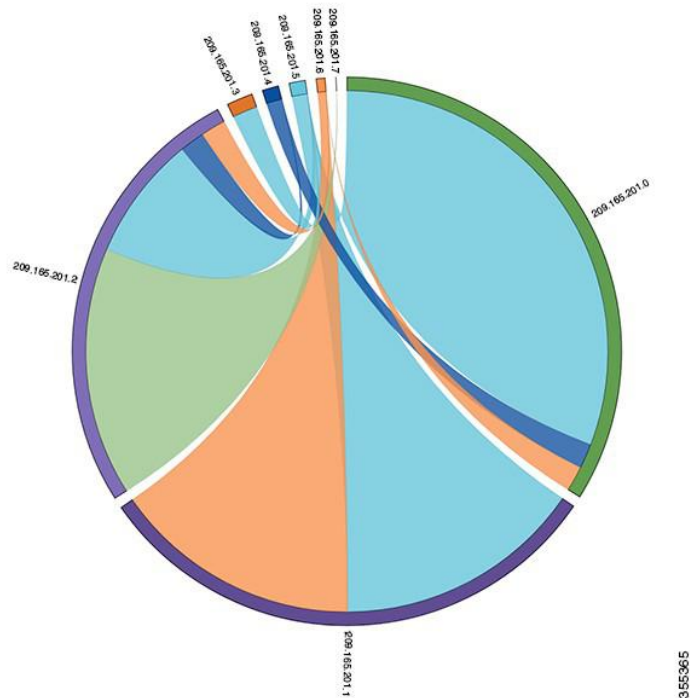

Every arc in the chord diagram represents the traffic flow from a source address to a destination address. The thick end of the chord represents the source address and the thin end represents the destination address. The thickness of the arc represents the percentage of the traffic. The Stats column in the output of the show icam entries command gives the information about the number of packets or traffic hitting a TCAM entry. The traffic from a single source to multiple destinations and from multiple sources to single destination can be visualized using the chord diagram.

The following figure shows the anomaly visualization of the traffic flow:

Figure 14 Anomaly Visualization

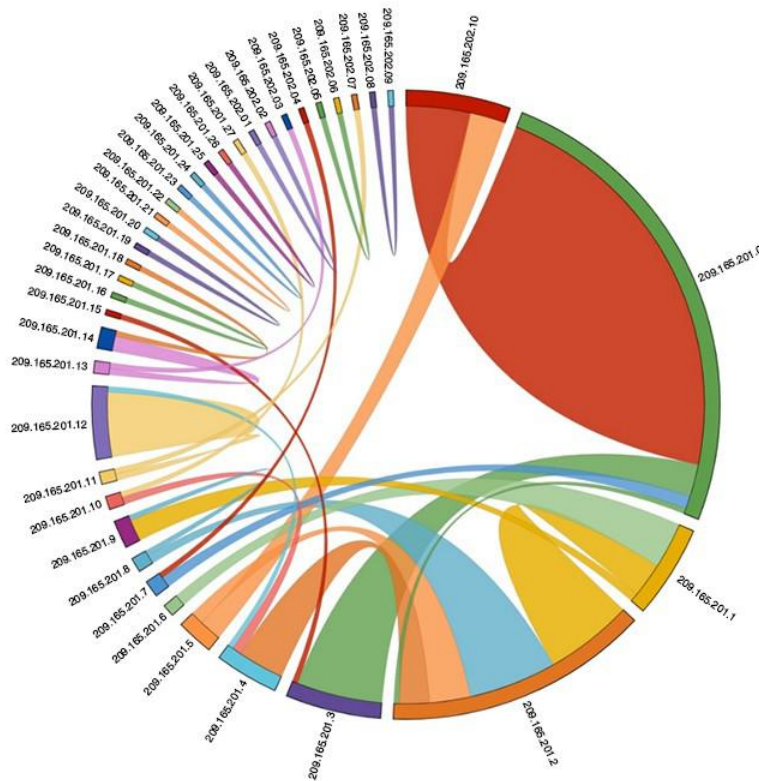

In the figure, the arcs with traffic from 209.165.201.0 to 209.165.202.10 can be easily identified as an anomalous traffic pattern.

## 21.10 Displaying Current, Historical, and Predictive TCAM Resource Usage per Feature

To display the current, historical, or predictive TCAM usage, use the following commands:

| Command                                                                                                                          | Description                                                                                                                                                                                                                                                                       |
|----------------------------------------------------------------------------------------------------------------------------------|-----------------------------------------------------------------------------------------------------------------------------------------------------------------------------------------------------------------------------------------------------------------------------------|
| <b>show icam resource</b> {acl-tcam   fib-tcam}<br><b>module</b><br><i>module inst instance</i> [ <b>history num-intervals</b> ] | Displays analytics per module and per instance for resources. <ul style="list-style-type: none"> <li><b>history</b>—Displays the traffic history of resources for the specified number of intervals.</li> <li><i>num-intervals</i>—Number of intervals in the history.</li> </ul> |
| <b>show icam prediction resource acl-tcam</b><br><b>module</b><br><i>module inst inst year month day time</i>                    | Displays the traffic prediction of the ACL-TCAM features such as ACL, QoS, PBR, WCCP, and so on. <ul style="list-style-type: none"> <li><i>year</i>—Specifies the year in the YYYY format. The values</li> </ul>                                                                  |

| Command                                                                                             | Description                                                                                                                                                                                                                                                                                        |
|-----------------------------------------------------------------------------------------------------|----------------------------------------------------------------------------------------------------------------------------------------------------------------------------------------------------------------------------------------------------------------------------------------------------|
|                                                                                                     | range from 1970 to 2030.<br>• <i>month</i> —Specifies the month as Jan, Feb, or so on.<br><b>Note</b> The values are case sensitive.<br>• <i>day</i> —Specifies the day of the month in the DD format. The values range from 1 to 31.<br>• <i>time</i> —Specifies the time in the HH:MM:SS format. |
| <b>show icam prediction resource fib-tcam module</b><br><i>module inst inst year month day time</i> | Displays the traffic prediction of the FIB TCAM resources.                                                                                                                                                                                                                                         |

You can generate a donut chart or a bar graph using the output of the above commands. The following figure shows the TCAM resource usage per feature:

Figure 15 Donut Chart Representing TCAM Resource Usage per Feature

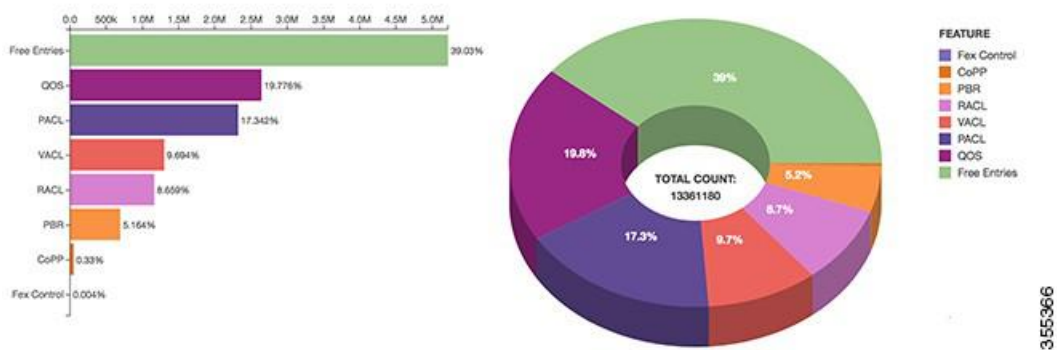

## 21.11 Explanation of the Display Outputs

When you enable iCAM monitoring for an entry or a resource, the corresponding traffic statistics or resources usage snapshot is stored in the database once in every interval.

This example shows the historical view of the TCAM entries monitored by iCAM. The Stats column shows the total amount of packets hitting the entry in the last five intervals. The Rate column shows the average traffic rate in packets per second in the last five intervals.

```

switch# show icam entries acl module 5 inst 0 history 5
=====
TCAM Entries (Mod 5,Inst 0): Cumulative stats for last 5 intervals

Feature Pkt_Type Source IP/Mask Dest IP/Mask Action ifindex Stats Rate(pps)

FEX IPv4 ip 0.0.0.0/0 0.0.0.0/0 Redirect
0x15090000 0 0
FEX IPv6 ip 0x00000000000000000000000000000000/0 0x000000000000000000000000
Redirect
0x15090000 0 0
FEX MAC 0000.0000.0000 0000.0000.0000 0000.0000.0000 0000.0000.0000
Redirect
0x15090000 0 0
FEX ARP arp-rarp/all ip 0.0.0.0/0 0.0.0.0/0 0000.0000.0000 0000.0000.00
Redirect

```



```

0x15090000 0 0
RACL IPv4
0x1a200000 23423 945
RACL IPv4
0x1a200000 23946237 718353
RACL IPv4
0x1a200000 83675 585
RACL IPv4
0x1a200000 0 0
RACL IPv4
0x1a200000 9693487 45986
RACL IPv4
0x1a200000 9693487 45986
RACL IPv4
0x1a200000 9693487 45986
QoS COPP IPv4 tcp 0.0.0.0/0 0.0.0.0/0 QoS
0x0 0 0
QoS COPP IPv4 udp 0.0.0.0/0 ip 209.165.201.7/27 0.0.0.0/0 QoS
0x0 0 0

```

This example shows the historical view of the TCAM resource utilization as snapshots. Each snapshot displays the state of TCAM utilization in the corresponding time interval.

```

switch# show icam resource fib_tcam module 5 inst 0 history 5
=====
FIB TCAM Resource Utilization (Mod 5, Inst 0)
=====

```

| Type         | logical | physical | Percent_Util | Timestamp (UTC)     |
|--------------|---------|----------|--------------|---------------------|
| IPV4 unicast | 16      | 16       | 0.00         | 2017-09-12 06:06:53 |
|              | 16      | 16       | 0.00         | 2017-09-12 07:06:53 |
|              | 16      | 16       | 0.00         | 2017-09-12 08:06:53 |
|              | 16      | 16       | 0.00         | 2017-09-12 09:06:53 |
|              | 16      | 16       | 0.00         | 2017-09-12 10:06:53 |
| DIAG_80      | 0       | 0        | 0.00         | 2017-09-12 06:06:53 |
|              | 0       | 0        | 0.00         | 2017-09-12 07:06:53 |
|              | 0       | 0        | 0.00         | 2017-09-12 08:06:53 |
| IPV4         | 0       | 0        | 0.00         | 2017-09-12 09:06:53 |
|              | 0       | 0        | 0.00         | 2017-09-12 10:06:53 |
|              | 6       | 6        | 0.00         | 2017-09-12 06:06:53 |
|              | 45      | 45       | 0.10         | 2017-09-12 07:06:53 |
|              | 45      | 45       | 0.10         | 2017-09-12 08:06:53 |
| MPLS         | 62      | 62       | 0.17         | 2017-09-12 09:06:53 |
|              | 62      | 62       | 0.17         | 2017-09-12 10:06:53 |
|              | 0       | 0        | 0.00         | 2017-09-12 06:06:53 |
|              | 0       | 0        | 0.00         | 2017-09-12 07:06:53 |
|              | 0       | 0        | 0.00         | 2017-09-12 08:06:53 |
|              | 0       | 0        | 0.00         | 2017-09-12 09:06:53 |
|              | 0       | 0        | 0.00         | 2017-09-12 10:06:53 |

## 21.12 Example: iCAM CLI Outputs

The following example shows how to view the running configuration for iCAM:

```

switch# show running-config icam
!Command: show running-config icam
!Time: Tue Sep 5 21:49:50 2017
version 8.2(1)
feature icam
icam monitor interval 1 num_intervals 168
icam monitor resource acl-tcam module 3 inst 4
icam monitor resource acl-tcam module 3 inst 5
icam monitor entries acl module 3 inst 5

```

```

icam monitor resource fib-tcam module 3 inst 5
icam monitor entries multicast module 3

```

This example shows how to view current TCAM entries and their traffic statistics.

```

switch# show icam entries acl module 3 inst 5
Retrieving data from linecard. This may take some time ...

```

```

=====
TCAM Entries (Mod 3,Inst 5)

```

| Feature    | Pkt_Type | Source IP/Mask                          | Dest IP/Mask               | Action         | ifindex           | Stats        |
|------------|----------|-----------------------------------------|----------------------------|----------------|-------------------|--------------|
| FEX        | IPv4     |                                         | ip 0.0.0.0/0               |                | 0.0.0.0/0         | Redirect     |
| 0x15090000 | 0        |                                         |                            |                |                   |              |
| FEX        | IPv6     | ip 0x00000000000000000000000000000000/0 | 0x000000000000000000000000 |                |                   | Redirect     |
| 0x15090000 | 0        |                                         |                            |                |                   |              |
| FEX        | MAC      | 0000.0000.0000                          | 0000.0000.0000             | 0000.0000.0000 | 0000.0000.0000    | Redirect     |
| 0x15090000 | 0        |                                         |                            |                |                   |              |
| FEX        | ARP      | arp-rarp/all                            | ip 0.0.0.0/0               | 0.0.0.0/0      | 0000.0000.0000    | 0000.0000.00 |
| 0x15090000 | 0        |                                         |                            |                |                   |              |
| RACL       | IPv4     |                                         | tcp 209.165.200.225/27     |                | 0.0.0.0/0         | Permit       |
| 0x1a10a000 | 0        |                                         |                            |                |                   |              |
| RACL       | IPv4     |                                         | tcp 209.165.201.1/27       |                | 0.0.0.0/0         | Permit       |
| 0x1a10a000 | 0        |                                         |                            |                |                   |              |
| RACL       | IPv4     |                                         | tcp 209.165.202.129/27     |                | 0.0.0.0/0         | Permit       |
| 0x1a10a000 | 0        |                                         |                            |                |                   |              |
| RACL       | IPv4     |                                         | tcp 209.165.202.139/27     |                | 0.0.0.0/0         | Permit       |
| 0x1a10a000 | 0        |                                         |                            |                |                   |              |
| RACL       | IPv4     |                                         | tcp 209.165.202.140/27     |                | 0.0.0.0/0         | Permit       |
| 0x1a10a000 | 0        |                                         |                            |                |                   |              |
| QoS        | COPP     | IPv4                                    | udp 0.0.0.0/0              |                | 209.165.201.3/27  |              |
| QoS        | 0x0      | 0                                       |                            |                |                   |              |
| QoS        | COPP     | IPv4                                    | udp 0.0.0.0/0              |                | 209.165.201.3/27  |              |
| QoS        | 0x0      | 0                                       |                            |                |                   |              |
| QoS        | COPP     | IPv4                                    |                            |                | 209.165.201.1/27  | 0.0.0.0/0    |
| QoS        | 0x0      | 0                                       |                            |                |                   |              |
| QoS        | COPP     | IPv4                                    | udp 0.0.0.0/0              |                | 209.165.201.1/27  |              |
| QoS        | 0x0      | 0                                       |                            |                |                   |              |
| QoS        | COPP     | IPv4                                    | udp 0.0.0.0/0              |                | 209.165.201.1/27  |              |
| QoS        | 0x0      | 0                                       |                            |                |                   |              |
| QoS        | COPP     | IPv4                                    | udp 0.0.0.0/0              |                | 209.165.201.7/27  |              |
| QoS        | 0x0      | 0                                       |                            |                |                   |              |
| QoS        | COPP     | IPv4                                    | udp 0.0.0.0/0              |                | 209.165.201.7/27  |              |
| QoS        | 0x0      | 0                                       |                            |                |                   |              |
| QoS        | COPP     | IPv4                                    | udp 0.0.0.0/0              |                | 209.165.201.11/27 |              |
| QoS        | 0x0      | 0                                       |                            |                |                   |              |
| QoS        | COPP     | IPv4                                    | udp 0.0.0.0/0              |                | 209.165.201.11/27 |              |
| QoS        | 0x0      | 0                                       |                            |                |                   |              |
| QoS        | COPP     | IPv4                                    | ip 0.0.0.0/0               |                | 209.165.201.14/27 |              |
| QoS        | 0x0      | 0                                       |                            |                |                   |              |

The following chord diagram is a simple representation of a complex traffic flow, where the traffic flow between the various sources and destinations is uniform.

Figure 16 Chord Diagram Representing Uniform Traffic Flow

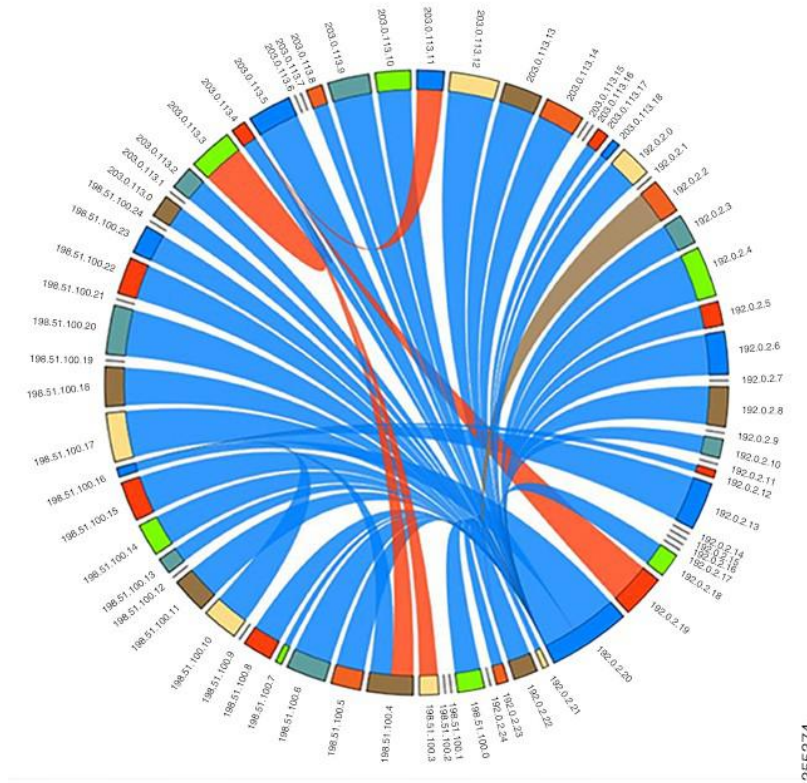

This example shows how to view the top 10% of TCAM entries for a current date and filtered by a feature name.

```
switch# show icam entries acl module 3 inst 5 sort filter "qos copp" top 10
Retrieving data from linecard. This may take some time ...
=====
TCAM Entries (Mod 3,Inst 5)

Feature Pkt_Type Source IP/Mask Dest IP/Mask Action
 ifindex Stats

QoS COPP IPv4
 0x0 38408890
 ip 0.0.0.0/0 0.0.0.0/0 QoS
QoS COPP MAC 0000.0000.0000 0000.0000.0000 0180.c200.000e ffff.ffff.ffff 350 QoS
 0x0 254
QoS COPP MAC 0000.0000.0000 0000.0000.0000 0100.0ccc.cccc ffff.ffff.ffff QoS
 0x0 23
QoS COPP IPv4
 0x0 0
 udp 0.0.0.0/0 209.165.201.1/27 QoS
QoS COPP IPv4
 0x0 0
 udp 0.0.0.0/0 209.165.201.1/27 QoS
```

This example shows how to view current TCAM entries filtered by a feature name using the exact keyword.

```
switch# show icam entries acl module 7 inst 0 sort filter QoS exact top 100
Retrieving data from linecard. This may take some time ...
=====
TCAM Entries (Mod 7,Inst 0)

```

| Feature | Pkt_Type | Source IP/Mask      | Dest IP/Mask       | Action         |
|---------|----------|---------------------|--------------------|----------------|
| ifindex | Stats    |                     |                    |                |
| QoS     | IPv4     | ip 209.165.201.1/27 | 209.165.202.129/27 | QoS 0x1a316000 |
| 0       |          |                     |                    |                |
| QoS     | IPv4     | ip 209.165.201.1/27 | 209.165.202.129/27 | QoS 0x1a316000 |
| 0       |          |                     |                    |                |
| QoS     | IPv4     | ip 209.165.201.2/27 | 209.165.202.129/27 | QoS 0x1a316000 |
| 0       |          |                     |                    |                |
| QoS     | IPv4     | ip 209.165.201.2/27 | 209.165.202.129/27 | QoS 0x1a316000 |
| 0       |          |                     |                    |                |
| QoS     | IPv4     | ip 209.165.201.3/27 | 209.165.202.129/27 | QoS 0x1a316000 |
| 0       |          |                     |                    |                |
| QoS     | IPv4     | ip 209.165.201.3/27 | 209.165.202.129/27 | QoS 0x1a316000 |
| 0       |          |                     |                    |                |
| QoS     | IPv4     | ip 0.0.0.0/0        | 0.0.0.0/0          | QoS 0x1a316000 |
| 0       |          |                     |                    |                |
| QoS     | IPv4     | ip 0.0.0.0/0        | 0.0.0.0/0          | QoS 0x1a316000 |
| 0       |          |                     |                    |                |

This example shows how to view the history of TCAM entries monitored by iCAM.

```

switch# show icam entries acl module 3 inst 5 history 2
=====
TCAM Entries (Mod 3,Inst 5): Cumulative stats for last 2 intervals
=====
Feature Pkt_Type Source IP/Mask Dest IP/Mask Action
ifindex Stats Rate(pps)
=====
FEX IPv4 ip 0.0.0.0/0 0.0.0.0/0 Redirect
0x15090000 0 0
FEX IPv6 ip 0x00000000000000000000000000000000/0 0x00000000000000000000000000000000 Redirect
0x15090000 0 0
FEX MAC 0000.0000.0000 0000.0000.0000 0000.0000.0000 0000.0000.0000 Redirect
0x15090000 0 0
FEX ARP arp-rarp/all ip 0.0.0.0/0 0.0.0.0/0 0000.0000.0000 0000.0000.00 Redirect
0x15090000 0 0
RACL IPv4 tcp 209.165.201.1/27 0.0.0.0/0 Permit
0x1a10a000 0 0
RACL IPv4 tcp 209.165.201.2/27 0.0.0.0/0 Permit
0x1a10a000 0 0
RACL IPv4 tcp 209.165.201.3/27 0.0.0.0/0 Permit
0x1a10a000 0 0
RACL IPv4 tcp 209.165.201.4/27 0.0.0.0/0 Permit
0x1a10a000 0 0
RACL IPv4 tcp 209.165.201.5/27 0.0.0.0/0 Permit
0x1a10a000 0 0
QoS COPP IPv4 udp 0.0.0.0/0 209.165.201.1/27 QoS
0x0 0 0
QoS COPP IPv4 udp 0.0.0.0/0 209.165.201.1/27 QoS
0x0 0 0
QoS COPP IPv4 udp 0.0.0.0/0 209.165.201.1/27 QoS
0x0 0 0
QoS COPP IPv4 udp 0.0.0.0/0 209.165.201.7/27 QoS
0x0 0 0
QoS COPP IPv4 udp 0.0.0.0/0 209.165.201.7/27 QoS
0x0 0 0
QoS COPP IPv4 udp 0.0.0.0/0 209.165.201.11/27 QoS
0x0 0 0

```

```

QoS COPP 0x0 0 0
 IPv4 udp 0.0.0.0/0 209.165.201.11/27 QoS
 0x0 0 0

```

This example shows how to view the history of top 1% of TCAM entries filtered by a feature name.

```

switch# show icam entries acl module 3 inst 5 history 2 sort filter "qos copp" top 1
=====
TCAM Entries (Mod 3,Inst 5): Cumulative stats for last 2 intervals

Feature Pkt_Type Source IP/Mask Dest IP/Mask Action ifindex
Stats Rate(pps)

QoS COPP MAC 0000.0000.0000 0000.0000.0000 0180.c200.000e ffff.ffff.ffff 350 QoS
 0x0 48 0
QoS COPP MAC 0000.0000.0000 0000.0000.0000 0100.0ccc.cccc ffff.ffff.ffff QoS
 0x0 4 0
QoS COPP IPv4 tcp 0.0.0.0/0 0.0.0.0/0 QoS
 0x0 0 0
QoS COPP IPv4 tcp 0.0.0.0/0 0.0.0.0/0 QoS
 0x0 0 0

```

This example displays the prediction for the traffic statistics of TCAM entries on a module and an instance for which iCAM monitoring is enabled.

```

switch# show icam prediction entries acl module 3 inst 5 2018 Jan 27 11:35:30
Generating predictions, this may take some time ...

=====
TCAM Entries Prediction (Mod 3,Inst 5)

Feature Pkt_Type Source IP/Mask Dest IP/Mask
Action ifindex Stats Prediction

QoS COPP IPv4 ip 0.0.0.0/0 0.0.0.0/0
QoS 0x0 38408890 38408890
QoS COPP MAC 0000.0000.0000 0000.0000.0000 0180.c200.000e ffff.ffff.ffff 350
QoS 0x0 485 501
QoS COPP MAC 0000.0000.0000 0000.0000.0000 0100.0ccc.cccc ffff.ffff.ffff
QoS 0x0 42 43
FEX IPv4 ip 0.0.0.0/0 0.0.0.0/0
Redirect 0x15090000 0 0

```

This example displays the predictive analytics of the top 2% TCAM entries.

```

switch# show icam prediction entries acl module 3 inst 5 2018 Jan 27 11:35:30 top 2
Generating predictions, this may take some time ...

=====
TCAM Entries Prediction (Mod 3,Inst 5)

Feature Pkt_Type Source IP/Mask Dest IP/Mask
Action ifindex Stats Prediction

QoS COPP IPv4 ip 0.0.0.0/0 0.0.0.0/0
QoS 0x0 38408890 38408890
QoS COPP MAC 0000.0000.0000 0000.0000.0000 0180.c200.000e ffff.ffff.ffff 350
QoS 0x0 485 501

```

```

QoS COPP MAC 0000.0000.0000 0000.0000.0000 0100.0ccc.cccc ffff.ffff.ffff
QoS 0x0 42 43
 FEX IPv6 ip 0x00000000000000000000000000000000/0 0x000000000000000000000000
Redirect 0x15090000 0 0
 FEX IPv4 ip 0.0.0.0/0 0.0.0.0/0
 Redirect 0x15090000 0
 FEX ARP arp-rarp/all ip 0.0.0.0/0 0.0.0.0/0 0000.0000.0000 0000.0000.00
Redirect 0x15090000 0 0
 FEX MAC 0000.0000.0000 0000.0000.0000 0000.0000.0000 0000.0000.0000
Redirect
0x15090000 0 0

```

This example shows how to view iCAM monitoring of the multicast entries for a current date.

```

switch# show icam entries multicast module 3
Retrieving data from linecard. This may take some time ...

=====
Multicast Entries (Mod 3)

```

| VDC_ID | TABLE_ID<br>RPF Stats | Source/Mask        | Group/Mask                     |
|--------|-----------------------|--------------------|--------------------------------|
| 1      | 1                     | 0.0.0.0/0          | 209.165.201.9/27               |
| 1      | 1                     | 209.165.201.18/27  | 209.165.201.10/27 Ethernet3/12 |
| 912494 | 1                     | 209.165.201.19/27  | 209.165.201.10/27 Ethernet3/12 |
| 912494 | 1                     | 209.165.201.20/27  | 209.165.201.10/27 Ethernet3/12 |
| 912494 | 1                     | 209.165.201.21/27  | 209.165.201.10/27 Ethernet3/12 |
| 912493 | 1                     | 209.165.201.22/27  | 209.165.201.10/27 Ethernet3/12 |
| 912493 | 1                     | 209.165.201.23/27  | 209.165.201.10/27 Ethernet3/12 |
| 912493 | 1                     | 209.165.201.24/27  | 209.165.201.10/27 Ethernet3/12 |
| 912493 | 1                     | 209.165.201.25/27  | 209.165.201.10/27 Ethernet3/12 |
| 912493 | 1                     | 209.165.201.26/27  | 209.165.201.10/27 Ethernet3/12 |
| 912480 | 1                     | 209.165.201.27/27  | 209.165.201.10/27 Ethernet3/12 |
| 912479 | 1                     | 209.165.201.28/27  | 209.165.201.10/27 Ethernet3/12 |
| 912479 | 1                     | 209.165.201.29/27  | 209.165.201.10/27 Ethernet3/12 |
| 912479 | 1                     | 209.165.201.30/27  | 209.165.201.10/27 Ethernet3/12 |
| 912479 | 1                     | 209.165.202.129/27 | 209.165.201.10/27 Ethernet3/12 |
| 912479 | 1                     | 209.165.202.130/27 | 209.165.201.10/27 Ethernet3/12 |
| 912471 | 1                     | 209.165.202.131/27 | 209.165.201.10/27 Ethernet3/12 |
| 912470 | 1                     | 209.165.202.132/27 | 209.165.201.10/27 Ethernet3/12 |
| 912470 | 1                     | 209.165.202.133/27 | 209.165.201.10/27 Ethernet3/12 |
| 912470 | 1                     | 209.165.202.134/27 | 209.165.201.10/27 Ethernet3/12 |

|        |   |                    |                   |              |  |
|--------|---|--------------------|-------------------|--------------|--|
| 912442 |   |                    |                   |              |  |
| 1      | 1 | 209.165.202.135/27 | 209.165.201.10/27 | Ethernet3/12 |  |
| 912442 |   |                    |                   |              |  |
| 1      | 1 | 209.165.202.136/27 | 209.165.201.10/27 | Ethernet3/12 |  |
| 912442 |   |                    |                   |              |  |
| 1      | 1 | 209.165.202.137/27 | 209.165.201.10/27 | Ethernet3/12 |  |
| 912441 |   |                    |                   |              |  |
| 1      | 1 | 209.165.202.138/27 | 209.165.201.10/27 | Ethernet3/12 |  |
| 912441 |   |                    |                   |              |  |
| 1      | 1 | 209.165.202.139/27 | 209.165.201.10/27 | Ethernet3/12 |  |
| 912441 |   |                    |                   |              |  |
| 1      | 1 | 209.165.202.140/27 | 209.165.201.10/27 | Ethernet3/12 |  |
| 912441 |   |                    |                   |              |  |
| 1      | 1 | 209.165.202.141/27 | 209.165.201.10/27 | Ethernet3/12 |  |
| 912431 |   |                    |                   |              |  |
| 1      | 1 | 209.165.202.142/27 | 209.165.201.10/27 | Ethernet3/12 |  |
| 912431 |   |                    |                   |              |  |
| 1      | 1 | 209.165.202.143/27 | 209.165.201.10/27 | Ethernet3/12 |  |
| 912431 |   |                    |                   |              |  |
| 1      | 1 | 209.165.202.144/27 | 209.165.201.10/27 | Ethernet3/12 |  |
| 912431 |   |                    |                   |              |  |
| 1      | 1 | 209.165.202.145/27 | 209.165.201.10/27 | Ethernet3/12 |  |
| 912411 |   |                    |                   |              |  |
| 1      | 1 | 209.165.202.146/27 | 209.165.201.10/27 | Ethernet3/12 |  |
| 912412 |   |                    |                   |              |  |
| 1      | 1 | 209.165.202.147/27 | 209.165.201.10/27 | Ethernet3/12 |  |
| 912411 |   |                    |                   |              |  |
| 1      | 1 | 209.165.202.148/27 | 209.165.201.10/27 | Ethernet3/12 |  |
| 912411 |   |                    |                   |              |  |
| 1      | 1 | 209.165.202.149/27 | 209.165.201.10/27 | Ethernet3/12 |  |
| 912411 |   |                    |                   |              |  |
| 1      | 1 | 209.165.202.150/27 | 209.165.201.10/27 | Ethernet3/12 |  |
| 912345 |   |                    |                   |              |  |
| 1      | 1 | 209.165.202.151/27 | 209.165.201.10/27 | Ethernet3/12 |  |
| 912345 |   |                    |                   |              |  |
| 1      | 1 | 209.165.202.152/27 | 209.165.201.10/27 | Ethernet3/12 |  |
| 912345 |   |                    |                   |              |  |
| 1      | 1 | 209.165.202.153/27 | 209.165.201.10/27 | Ethernet3/12 |  |
| 912345 |   |                    |                   |              |  |
| 1      | 1 | 209.165.202.154/27 | 209.165.201.10/27 | Ethernet3/12 |  |
| 912345 |   |                    |                   |              |  |
| 1      | 1 | 209.165.202.155/27 | 209.165.201.10/27 | Ethernet3/12 |  |
| 912345 |   |                    |                   |              |  |
| 1      | 1 | 209.165.202.156/27 | 209.165.201.10/27 | Ethernet3/12 |  |
| 912344 |   |                    |                   |              |  |
| 1      | 1 | 209.165.202.157/27 | 209.165.201.10/27 | Ethernet3/12 |  |
| 912333 |   |                    |                   |              |  |
| 1      | 1 | 209.165.202.158/27 | 209.165.201.10/27 | Ethernet3/12 |  |
| 912333 |   |                    |                   |              |  |

This example shows how to view the top 1% multicast entries monitored by iCAM for a current date.

```
switch# show icam entries multicast module 3 sort top 1
Retrieving data from linecard. This may take some time ...
```

```
=====
```

## Multicast Entries (Mod 3)

| VDC_ID | TABLE_ID<br>RPF Stats | Source/Mask                        | Group/Mask        |
|--------|-----------------------|------------------------------------|-------------------|
| 1      | 1                     | 209.165.200.225/27<br>Ethernet3/12 | 209.165.201.10/27 |
| 933495 |                       |                                    |                   |
| 1      | 1                     | 209.165.200.226/27<br>Ethernet3/12 | 209.165.201.10/27 |
| 933491 |                       |                                    |                   |
| 1      | 1                     | 209.165.200.227/27<br>Ethernet3/12 | 209.165.201.10/27 |
| 933488 |                       |                                    |                   |
| 1      | 1                     | 209.165.200.228/27<br>Ethernet3/12 | 209.165.201.10/27 |
| 933483 |                       |                                    |                   |
| 1      | 1                     | 209.165.200.229/27<br>Ethernet3/12 | 209.165.201.10/27 |
| 933483 |                       |                                    |                   |
| 1      | 1                     | 209.165.200.230/27<br>Ethernet3/12 | 209.165.201.10/27 |
| 933480 |                       |                                    |                   |
| 1      | 1                     | 209.165.200.231/27<br>Ethernet3/12 | 209.165.201.10/27 |
| 933476 |                       |                                    |                   |
| 1      | 1                     | 209.165.200.232/27<br>Ethernet3/12 | 209.165.201.10/27 |
| 933474 |                       |                                    |                   |
| 1      | 1                     | 209.165.200.233/27<br>Ethernet3/12 | 209.165.201.10/27 |
| 933469 |                       |                                    |                   |
| 1      | 1                     | 209.165.200.234/27<br>Ethernet3/12 | 209.165.201.10/27 |
| 933469 |                       |                                    |                   |
| 1      | 1                     | 209.165.200.235/27<br>Ethernet3/12 | 209.165.201.10/27 |
| 933466 |                       |                                    |                   |
| 1      | 1                     | 209.165.200.236/27<br>Ethernet3/12 | 209.165.201.10/27 |
| 933462 |                       |                                    |                   |
| 1      | 1                     | 209.165.200.237/27<br>Ethernet3/12 | 209.165.201.10/27 |
| 933456 |                       |                                    |                   |
| 1      | 1                     | 209.165.200.238/27<br>Ethernet3/12 | 209.165.201.10/27 |
| 933455 |                       |                                    |                   |
| 1      | 1                     | 209.165.201.1/27<br>Ethernet3/12   | 209.165.201.10/27 |
| 933455 |                       |                                    |                   |
| 1      | 1                     | 209.165.201.2/27<br>Ethernet3/12   | 209.165.201.10/27 |
| 933452 |                       |                                    |                   |
| 1      | 1                     | 209.165.201.3/27<br>Ethernet3/12   | 209.165.201.10/27 |
| 933449 |                       |                                    |                   |
| 1      | 1                     | 209.165.201.4/27<br>Ethernet3/12   | 209.165.201.10/27 |
| 933442 |                       |                                    |                   |
| 1      | 1                     | 209.165.201.5/27<br>Ethernet3/12   | 209.165.201.10/27 |
| 933441 |                       |                                    |                   |
| 1      | 1                     | 209.165.201.6/27<br>Ethernet3/12   | 209.165.201.10/27 |



---

|        |   |   |                                   |                   |
|--------|---|---|-----------------------------------|-------------------|
| 933441 | 1 | 1 | 209.165.201.7/27<br>Ethernet3/12  | 209.165.201.10/27 |
| 933441 | 1 | 1 | 209.165.201.8/27<br>Ethernet3/12  | 209.165.201.10/27 |
| 933435 | 1 | 1 | 209.165.201.9/27<br>Ethernet3/12  | 209.165.201.10/27 |
| 933434 | 1 | 1 | 209.165.201.11/27<br>Ethernet3/12 | 209.165.201.10/27 |
| 933418 | 1 | 1 | 209.165.201.12/27<br>Ethernet3/12 | 209.165.201.10/27 |
| 933202 | 1 | 1 | 209.165.201.13/27<br>Ethernet3/12 | 209.165.201.10/27 |
| 933202 | 1 | 1 | 209.165.201.14/27<br>Ethernet3/12 | 209.165.201.10/27 |
| 933202 | 1 | 1 | 209.165.201.15/27<br>Ethernet3/12 | 209.165.201.10/27 |
| 933202 | 1 | 1 | 209.165.201.16/27<br>Ethernet3/12 | 209.165.201.10/27 |
| 933202 | 1 | 1 | 209.165.201.17/27<br>Ethernet3/12 | 209.165.201.10/27 |
| 933202 | 1 | 1 | 209.165.201.18/27<br>Ethernet3/12 | 209.165.201.10/27 |
| 933202 | 1 | 1 | 209.165.201.19/27<br>Ethernet3/12 | 209.165.201.10/27 |
| 933202 | 1 | 1 | 209.165.201.20/27<br>Ethernet3/12 | 209.165.201.10/27 |
| 933188 | 1 | 1 | 209.165.201.21/27<br>Ethernet3/12 | 209.165.201.10/27 |
| 933187 | 1 | 1 | 209.165.201.22/27<br>Ethernet3/12 | 209.165.201.10/27 |
| 933187 | 1 | 1 | 209.165.201.23/27<br>Ethernet3/12 | 209.165.201.10/27 |
| 933187 | 1 | 1 | 209.165.201.24/27<br>Ethernet3/12 | 209.165.201.10/27 |
| 933187 | 1 | 1 | 209.165.201.25/27<br>Ethernet3/12 | 209.165.201.10/27 |
| 933187 | 1 | 1 | 209.165.201.26/27<br>Ethernet3/12 | 209.165.201.10/27 |
| 933187 | 1 | 1 | 209.165.201.27/27<br>Ethernet3/12 | 209.165.201.10/27 |
| 933179 | 1 | 1 | 209.165.201.28/27<br>Ethernet3/12 | 209.165.201.10/27 |
| 933178 | 1 | 1 | 209.165.201.29/27<br>Ethernet3/12 | 209.165.201.10/27 |

```

933178
1 1 209.165.201.30/27 209.165.201.10/27
 Ethernet3/12
933150
1 1 209.165.202.129/27 209.165.201.10/27
 Ethernet3/12
933150
1 1 209.165.202.130/27 209.165.201.10/27
 Ethernet3/12
933150
1 1 209.165.202.131/27 209.165.201.10/27
 Ethernet3/12
933149
1 1 209.165.202.132/27 209.165.201.10/27
 Ethernet3/12
933149
1 1 209.165.202.133/27 209.165.201.10/27
 Ethernet3/12
933149
1 1 209.165.202.134/27 209.165.201.10/27
 Ethernet3/12
933149
1 1 209.165.202.135/27 209.165.201.10/27
 Ethernet3/12
933139

```

This example shows how to view the history of multicast entries monitored by iCAM.

```

switch# show icam entries multicast module 3 history 2
=====
Multicast Entries (Mod 3): Cumulative stats for last 2 intervals

```

| VDC_ID | TABLE_ID   | Source/Mask       | Group/Mask        | RPF          |
|--------|------------|-------------------|-------------------|--------------|
| Stats  | Rate (pps) |                   |                   |              |
| 1      | 0          | 0.0.0.0/0         | 209.165.201.9/27  |              |
| 1      | 165792     | 209.165.201.18/27 | 209.165.201.10/27 | Ethernet3/12 |
| 1      | 165792     | 209.165.201.19/27 | 209.165.201.10/27 | Ethernet3/12 |
| 1      | 165793     | 209.165.201.20/27 | 209.165.201.10/27 | Ethernet3/12 |
| 1      | 165793     | 209.165.201.21/27 | 209.165.201.10/27 | Ethernet3/12 |
| 1      | 165793     | 209.165.201.22/27 | 209.165.201.10/27 | Ethernet3/12 |
| 1      | 165792     | 209.165.201.23/27 | 209.165.201.10/27 | Ethernet3/12 |
| 1      | 165792     | 209.165.201.24/27 | 209.165.201.10/27 | Ethernet3/12 |
| 1      | 165792     | 209.165.201.25/27 | 209.165.201.10/27 | Ethernet3/12 |
| 1      | 165792     | 209.165.201.26/27 | 209.165.201.10/27 | Ethernet3/12 |

|        |   |                    |                   |
|--------|---|--------------------|-------------------|
| 1      | 1 | 209.165.201.27/27  | 209.165.201.10/27 |
| 165792 |   | Ethernet3/12       |                   |
| 1      | 1 | 209.165.201.28/27  | 209.165.201.10/27 |
| 165792 |   | Ethernet3/12       |                   |
| 1      | 1 | 209.165.201.29/27  | 209.165.201.10/27 |
| 165792 |   | Ethernet3/12       |                   |
| 1      | 1 | 209.165.201.30/27  | 209.165.201.10/27 |
| 165792 |   | Ethernet3/12       |                   |
| 1      | 1 | 209.165.202.129/27 | 209.165.201.10/27 |
| 165792 |   | Ethernet3/12       |                   |
| 1      | 1 | 209.165.202.130/27 | 209.165.201.10/27 |
| 165792 |   | Ethernet3/12       |                   |
| 1      | 1 | 209.165.202.131/27 | 209.165.201.10/27 |
| 165792 |   | Ethernet3/12       |                   |
| 1      | 1 | 209.165.202.132/27 | 209.165.201.10/27 |
| 165792 |   | Ethernet3/12       |                   |
| 1      | 1 | 209.165.202.133/27 | 209.165.201.10/27 |
| 165792 |   | Ethernet3/12       |                   |
| 1      | 1 | 209.165.202.134/27 | 209.165.201.10/27 |
| 165792 |   | Ethernet3/12       |                   |
| 1      | 1 | 209.165.202.135/27 | 209.165.201.10/27 |
| 165792 |   | Ethernet3/12       |                   |
| 1      | 1 | 209.165.202.136/27 | 209.165.201.10/27 |
| 165792 |   | Ethernet3/12       |                   |
| 1      | 1 | 209.165.202.137/27 | 209.165.201.10/27 |
| 165792 |   | Ethernet3/12       |                   |
| 1      | 1 | 209.165.202.138/27 | 209.165.201.10/27 |
| 165792 |   | Ethernet3/12       |                   |
| 1      | 1 | 209.165.202.139/27 | 209.165.201.10/27 |
| 165792 |   | Ethernet3/12       |                   |
| 1      | 1 | 209.165.202.140/27 | 209.165.201.10/27 |
| 165792 |   | Ethernet3/12       |                   |
| 1      | 1 | 209.165.202.141/27 | 209.165.201.10/27 |
| 165792 |   | Ethernet3/12       |                   |
| 1      | 1 | 209.165.202.142/27 | 209.165.201.10/27 |
| 165792 |   | Ethernet3/12       |                   |
| 1      | 1 | 209.165.202.143/27 | 209.165.201.10/27 |
| 165792 |   | Ethernet3/12       |                   |
| 1      | 1 | 209.165.202.144/27 | 209.165.201.10/27 |
| 165792 |   | Ethernet3/12       |                   |
| 1      | 1 | 209.165.202.145/27 | 209.165.201.10/27 |
| 165792 |   | Ethernet3/12       |                   |
| 1      | 1 | 209.165.202.146/27 | 209.165.201.10/27 |
| 165792 |   | Ethernet3/12       |                   |

```

1 1 209.165.202.147/27 209.165.201.10/27
 Ethernet3/12
165792 690
1 1 209.165.202.148/27 209.165.201.10/27
 Ethernet3/12
165792 690
1 1 209.165.202.149/27 209.165.201.10/27
 Ethernet3/12
165792 690
1 1 209.165.202.150/27 209.165.201.10/27
 Ethernet3/12
165792 690
1 1 209.165.202.151/27 209.165.201.10/27
 Ethernet3/12
165792 690
1 1 209.165.202.152/27 209.165.201.10/27
 Ethernet3/12
165792 690
1 1 209.165.202.153/27 209.165.201.10/27
 Ethernet3/12
165792 690
1 1 209.165.202.154/27 209.165.201.10/27
 Ethernet3/12
165792 690
1 1 209.165.202.155/27 209.165.201.10/27
 Ethernet3/12
165792 690
1 1 209.165.202.156/27 209.165.201.10/27
 Ethernet3/12
165792 690
1 1 209.165.202.157/27 209.165.201.10/27
 Ethernet3/12
165792 690
1 1 209.165.202.158/27 209.165.201.10/27
 Ethernet3/12
165792 690
.
.
.

```

This example shows how to view the history of top 1% multicast entries monitored by iCAM.

```

switch# show icam entries multicast module 3 history 2 sort top 1
=====
Multicast Entries (Mod 3): Cumulative stats for last 2 intervals
=====

```

| VDC_ID | TABLE_ID<br>RPF Stats | Source/Mask        | Group/Mask<br>Rate (pps) |
|--------|-----------------------|--------------------|--------------------------|
| 1      | 1                     | 209.165.200.225/27 | 209.165.201.10/27        |
| 165725 | 690                   |                    |                          |
| 1      | 1                     | 209.165.200.226/27 | 209.165.201.10/27        |
| 165725 | 690                   |                    |                          |
| 1      | 1                     | 209.165.200.227/27 | 209.165.201.10/27        |
| 165725 | 690                   |                    |                          |
| 1      | 1                     | 209.165.200.228/27 | 209.165.201.10/27        |
| 165725 | 690                   |                    |                          |
| 1      | 1                     | 209.165.200.229/27 | 209.165.201.10/27        |
| 165725 | 690                   |                    |                          |

|        |     |                                    |                   |
|--------|-----|------------------------------------|-------------------|
| 165725 | 690 |                                    |                   |
| 1      | 1   | 209.165.200.230/27<br>Ethernet3/12 | 209.165.201.10/27 |
| 165725 | 690 |                                    |                   |
| 1      | 1   | 209.165.200.231/27<br>Ethernet3/12 | 209.165.201.10/27 |
| 165725 | 690 |                                    |                   |
| 1      | 1   | 209.165.200.232/27<br>Ethernet3/12 | 209.165.201.10/27 |
| 165725 | 690 |                                    |                   |
| 1      | 1   | 209.165.200.233/27<br>Ethernet3/12 | 209.165.201.10/27 |
| 165725 | 690 |                                    |                   |
| 1      | 1   | 209.165.200.234/27<br>Ethernet3/12 | 209.165.201.10/27 |
| 165725 | 690 |                                    |                   |
| 1      | 1   | 209.165.200.235/27<br>Ethernet3/12 | 209.165.201.10/27 |
| 165724 | 690 |                                    |                   |
| 1      | 1   | 209.165.200.236/27<br>Ethernet3/12 | 209.165.201.10/27 |
| 165724 | 690 |                                    |                   |
| 1      | 1   | 209.165.200.237/27<br>Ethernet3/12 | 209.165.201.10/27 |
| 165724 | 690 |                                    |                   |
| 1      | 1   | 209.165.201.1/27<br>Ethernet3/12   | 209.165.201.10/27 |
| 165724 | 690 |                                    |                   |
| 1      | 1   | 209.165.201.2/27<br>Ethernet3/12   | 209.165.201.10/27 |
| 165724 | 690 |                                    |                   |
| 1      | 1   | 209.165.201.3/27<br>Ethernet3/12   | 209.165.201.10/27 |
| 165724 | 690 |                                    |                   |
| 1      | 1   | 209.165.201.4/27<br>Ethernet3/12   | 209.165.201.10/27 |
| 165724 | 690 |                                    |                   |
| 1      | 1   | 209.165.201.5/27<br>Ethernet3/12   | 209.165.201.10/27 |
| 165724 | 690 |                                    |                   |
| 1      | 1   | 209.165.201.6/27<br>Ethernet3/12   | 209.165.201.10/27 |
| 165724 | 690 |                                    |                   |
| 1      | 1   | 209.165.201.7/27<br>Ethernet3/12   | 209.165.201.10/27 |
| 165724 | 690 |                                    |                   |
| 1      | 1   | 209.165.201.8/27<br>Ethernet3/12   | 209.165.201.10/27 |
| 165724 | 690 |                                    |                   |
| 1      | 1   | 209.165.201.9/27<br>Ethernet3/12   | 209.165.201.10/27 |
| 165724 | 690 |                                    |                   |
| 1      | 1   | 209.165.201.11/27<br>Ethernet3/12  | 209.165.201.10/27 |
| 165724 | 690 |                                    |                   |
| 1      | 1   | 209.165.201.12/27<br>Ethernet3/12  | 209.165.201.10/27 |
| 165724 | 690 |                                    |                   |
| 1      | 1   | 209.165.201.13/27<br>Ethernet3/12  | 209.165.201.10/27 |
| 165724 | 690 |                                    |                   |
| 1      | 1   | 209.165.201.14/27<br>Ethernet3/12  | 209.165.201.10/27 |
| 165724 | 690 |                                    |                   |
| 1      | 1   | 209.165.201.15/27<br>Ethernet3/12  | 209.165.201.10/27 |

```

165724 690
1 1 209.165.201.16/27 209.165.201.10/27
 Ethernet3/12
165724 690
1 1 209.165.201.17/27 209.165.201.10/27
 Ethernet3/12
165724 690
1 1 209.165.201.18/27 209.165.201.10/27
 Ethernet3/12
165724 690
1 1 209.165.201.19/27 209.165.201.10/27
 Ethernet3/12
165724 690
1 1 209.165.201.20/27 209.165.201.10/27
 Ethernet3/12
165724 690
1 1 209.165.201.21/27 209.165.201.10/27
 Ethernet3/12
165724 690
1 1 209.165.201.22/27 209.165.201.10/27
 Ethernet3/12
165724 690
1 1 209.165.201.23/27 209.165.201.10/27
 Ethernet3/12
165724 690
1 1 209.165.201.24/27 209.165.201.10/27
 Ethernet3/12
165724 690
1 1 209.165.201.25/27 209.165.201.10/27
 Ethernet3/12
165724 690
1 1 209.165.201.26/27 209.165.201.10/27
 Ethernet3/12
165724 690
1 1 209.165.201.27/27 209.165.201.10/27
 Ethernet3/12
165724 690
1 1 209.165.201.28/27 209.165.201.10/27
 Ethernet3/12
165724 690
1 1 209.165.201.29/27 209.165.201.10/27
 Ethernet3/12
165724 690
1 1 209.165.201.30/27 209.165.201.10/27
 Ethernet3/12
165724 690
1 1 209.165.202.129/27 209.165.201.10/27 Ethernet3/12
165724 690
1 1 209.165.202.130/27 209.165.201.10/27 Ethernet3/12
165724 690
1 1 209.165.202.131/27 209.165.201.10/27 Ethernet3/12
165724 690
1 1 209.165.202.132/27 209.165.201.10/27 Ethernet3/12
165724 690
1 1 209.165.202.133/27 209.165.201.10/27 Ethernet3/12
165724 690
1 1 209.165.202.134/27 209.165.201.10/27 Ethernet3/12
165724 690
1 1 209.165.202.135/27 209.165.201.10/27 Ethernet3/12
165724 690

```

This example displays the predictive analytics of the multicast entries.

```
switch# show icam prediction entries multicast module 3 2020 Jul 19 08:10:29
```

Generating predictions, this may take some time ...

=====  
 Multicast Entries Prediction (Mod 3)  
 =====

| VDC_ID  | TABLE_ID   | Source/Mask        | Group/Mask         | RPF          |
|---------|------------|--------------------|--------------------|--------------|
| Stats   | Prediction |                    |                    |              |
| 1       | 1          | 209.165.202.129/27 | 209.165.200.225/27 | Ethernet3/12 |
| 1679387 |            | 1679387            |                    |              |
| 1       | 1          | 209.165.201.23/27  | 209.165.200.225/27 | Ethernet3/12 |
| 1679419 |            | 1679419            |                    |              |
| 1       | 1          | 209.165.201.24/27  | 209.165.200.225/27 | Ethernet3/12 |
| 1679411 |            | 1679411            |                    |              |
| 1       | 1          | 209.165.201.25/27  | 209.165.200.225/27 | Ethernet3/12 |
| 1679411 |            | 1679411            |                    |              |
| 1       | 1          | 209.165.201.26/27  | 209.165.200.225/27 | Ethernet3/12 |
| 1679411 |            | 1679411            |                    |              |
| 1       | 1          | 209.165.201.27/27  | 209.165.200.225/27 | Ethernet3/12 |
| 1679411 |            | 1679411            |                    |              |
| 1       | 1          | 209.165.201.28/27  | 209.165.200.225/27 | Ethernet3/12 |
| 1679404 |            | 1679404            |                    |              |
| 1       | 1          | 209.165.201.29/27  | 209.165.200.225/27 | Ethernet3/12 |
| 1679403 |            | 1679403            |                    |              |
| 1       | 1          | 209.165.201.30/27  | 209.165.200.225/27 | Ethernet3/12 |
| 1679403 |            | 1679403            |                    |              |
| 1       | 1          | 209.165.201.8/27   | 209.165.200.225/27 | Ethernet3/12 |
| 1679113 |            | 1679113            |                    |              |
| 1       | 1          | 209.165.201.7/27   | 209.165.200.225/27 | Ethernet3/12 |
| 1679113 |            | 1679113            |                    |              |
| 1       | 1          | 209.165.201.4/27   | 209.165.200.225/27 | Ethernet3/12 |
| 1679141 |            | 1679141            |                    |              |
| 1       | 1          | 209.165.201.3/27   | 209.165.200.225/27 | Ethernet3/12 |
| 1679142 |            | 1679142            |                    |              |
| 1       | 1          | 209.165.201.6/27   | 209.165.200.225/27 | Ethernet3/12 |
| 1679113 |            | 1679113            |                    |              |
| 1       | 1          | 209.165.201.5/27   | 209.165.200.225/27 | Ethernet3/12 |
| 1679141 |            | 1679141            |                    |              |
| 1       | 1          | 209.165.200.238/27 | 209.165.200.225/27 | Ethernet3/12 |
| 1679150 |            | 1679150            |                    |              |
| 1       | 1          | 209.165.200.237/27 | 209.165.200.225/27 | Ethernet3/12 |
| 1679150 |            | 1679150            |                    |              |
| 1       | 1          | 209.165.201.2/27   | 209.165.200.225/27 | Ethernet3/12 |
| 1679150 |            | 1679150            |                    |              |
| 1       | 1          | 209.165.201.1/27   | 209.165.200.225/27 | Ethernet3/12 |
| 1679150 |            | 1679150            |                    |              |
| 1       | 1          | 209.165.200.226/27 | 209.165.200.225/27 | Ethernet3/12 |
| 1679166 |            | 1679166            |                    |              |
| 1       | 1          | 209.165.201.22/27  | 209.165.200.225/27 | Ethernet3/12 |
| 1679422 |            | 1679422            |                    |              |
| 1       | 1          | 209.165.201.21/27  | 209.165.200.225/27 | Ethernet3/12 |
| 1679424 |            | 1679424            |                    |              |
| 1       | 1          | 209.165.201.20/27  | 209.165.200.225/27 | Ethernet3/12 |
| 1679424 |            | 1679424            |                    |              |
| 1       | 1          | 209.165.201.19/27  | 209.165.200.225/27 | Ethernet3/12 |
| 1679425 |            | 1679425            |                    |              |
| 1       | 1          | 209.165.201.18/27  | 209.165.200.225/27 | Ethernet3/12 |
| 1679431 |            | 1679431            |                    |              |
| 1       | 1          | 209.165.201.17/27  | 209.165.200.225/27 | Ethernet3/12 |
| 1679435 |            | 1679435            |                    |              |
| 1       | 1          | 209.165.201.16/27  | 209.165.200.225/27 | Ethernet3/12 |
| 1679438 |            | 1679438            |                    |              |
| 1       | 1          | 209.165.201.15/27  | 209.165.200.225/27 | Ethernet3/12 |

|         |   |                    |                    |              |  |
|---------|---|--------------------|--------------------|--------------|--|
| 1679438 |   | 1679438            |                    |              |  |
| 1       | 1 | 209.165.201.14/27  | 209.165.200.225/27 | Ethernet3/12 |  |
| 1679443 |   | 1679443            |                    |              |  |
| 1       | 1 | 209.165.201.13/27  | 209.165.200.225/27 | Ethernet3/12 |  |
| 1679445 |   | 1679445            |                    |              |  |
| 1       | 1 | 209.165.200.235/27 | 209.165.200.225/27 | Ethernet3/12 |  |
| 1679150 |   | 1679150            |                    |              |  |
| 1       | 1 | 209.165.200.236/27 | 209.165.200.225/27 | Ethernet3/12 |  |
| 1679150 |   | 1679150            |                    |              |  |
| 1       | 1 | 209.165.200.233/27 | 209.165.200.225/27 | Ethernet3/12 |  |
| 1679165 |   | 1679165            |                    |              |  |
| 1       | 1 | 209.165.200.234/27 | 209.165.200.225/27 | Ethernet3/12 |  |
| 1679151 |   | 1679151            |                    |              |  |
| 1       | 1 | 209.165.200.231/27 | 209.165.200.225/27 | Ethernet3/12 |  |
| 1679165 |   | 1679165            |                    |              |  |
| 1       | 1 | 209.165.200.232/27 | 209.165.200.225/27 | Ethernet3/12 |  |
| 1679165 |   | 1679165            |                    |              |  |
| 1       | 1 | 209.165.200.229/27 | 209.165.200.225/27 | Ethernet3/12 |  |
| 1679165 |   | 1679165            |                    |              |  |
| 1       | 1 | 209.165.200.230/27 | 209.165.200.225/27 | Ethernet3/12 |  |
| 1679165 |   | 1679165            |                    |              |  |
| 1       | 1 | 209.165.200.227/27 | 209.165.200.225/27 | Ethernet3/12 |  |
| 1679166 |   | 1679166            |                    |              |  |
| 1       | 1 | 209.165.200.228/27 | 209.165.200.225/27 | Ethernet3/12 |  |
| 1679166 |   | 1679166            |                    |              |  |
| 1       | 1 | 209.165.201.12/27  | 209.165.200.225/27 | Ethernet3/12 |  |
| 1679103 |   | 1679103            |                    |              |  |
| 1       | 1 | 209.165.201.9/27   | 209.165.200.225/27 | Ethernet3/12 |  |
| 1679112 |   | 1679112            |                    |              |  |
| 1       | 1 | 209.165.201.10/27  | 209.165.200.225/27 | Ethernet3/12 |  |
| 1679113 |   | 1679113            |                    |              |  |
| 1       | 1 | 209.165.201.11/27  | 209.165.200.225/27 | Ethernet3/12 |  |
| 1679113 |   | 1679113            |                    |              |  |

This example displays the predictive analytics of the top 1% multicast entries.

```

switch# show icam prediction entries multicast module 3 2020 Jul 19 08:10:29 top 1
Generating predictions, this may take some time ...

=====
Multicast Entries Prediction (Mod 3)

VDC_ID TABLE_ID Source/Mask Group/Mask RPF
 Stats Prediction

 1 1 209.165.202.129/27 209.165.200.225/27 Ethernet3/12
1679387 1679387

 1 1 209.165.201.23/27 209.165.200.225/27
 Ethernet3/12
1679419 1679419
 1 1 209.165.201.24/27 209.165.200.225/27
 Ethernet3/12
1679411 1679411
 1 1 209.165.201.25/27 209.165.200.225/27
 Ethernet3/12
1679411 1679411
 1 1 209.165.201.26/27 209.165.200.225/27
 Ethernet3/12

```



---

|         |         |                                      |                    |
|---------|---------|--------------------------------------|--------------------|
| 1679411 | 1679411 |                                      |                    |
| 1       |         | 1209.165.201.27/27<br>Ethernet3/12   | 209.165.200.225/27 |
| 1679411 | 1679411 |                                      |                    |
| 1       |         | 1 209.165.201.28/27<br>Ethernet3/12  | 209.165.200.225/27 |
| 1679404 | 1679404 |                                      |                    |
| 1       |         | 1 209.165.201.29/27<br>Ethernet3/12  | 209.165.200.225/27 |
| 1679403 | 1679403 |                                      |                    |
| 1       |         | 1 209.165.201.30/27<br>Ethernet3/12  | 209.165.200.225/27 |
| 1679403 | 1679403 |                                      |                    |
| 1       |         | 1209.165.201.8/27<br>Ethernet3/12    | 209.165.200.225/27 |
| 1679113 | 1679113 |                                      |                    |
| 1       |         | 1209.165.201.7/27<br>Ethernet3/12    | 209.165.200.225/27 |
| 1679113 | 1679113 |                                      |                    |
| 1       |         | 1 209.165.201.4/27<br>Ethernet3/12   | 209.165.200.225/27 |
| 1679141 | 1679141 |                                      |                    |
| 1       |         | 1 209.165.201.3/27<br>Ethernet3/12   | 209.165.200.225/27 |
| 1679142 | 1679142 |                                      |                    |
| 1       |         | 1 209.165.201.6/27<br>Ethernet3/12   | 209.165.200.225/27 |
| 1679113 | 1679113 |                                      |                    |
| 1       |         | 1209.165.201.5/27<br>Ethernet3/12    | 209.165.200.225/27 |
| 1679141 | 1679141 |                                      |                    |
| 1       |         | 1 209.165.200.238/27<br>Ethernet3/12 | 209.165.200.225/27 |
| 1679150 | 1679150 |                                      |                    |
| 1       |         | 1 209.165.200.237/27<br>Ethernet3/12 | 209.165.200.225/27 |
| 1679150 | 1679150 |                                      |                    |
| 1       |         | 1 209.165.201.2/27<br>Ethernet3/12   | 209.165.200.225/27 |
| 1679150 | 1679150 |                                      |                    |
| 1       |         | 1 209.165.201.1/27<br>Ethernet3/12   | 209.165.200.225/27 |
| 1679150 | 1679150 |                                      |                    |
| 1       |         | 1 209.165.200.226/27<br>Ethernet3/12 | 209.165.200.225/27 |
| 1679166 | 1679166 |                                      |                    |
| 1       |         | 1 209.165.201.22/27<br>Ethernet3/12  | 209.165.200.225/27 |
| 1679422 | 1679422 |                                      |                    |
| 1       |         | 1 209.165.201.21/27<br>Ethernet3/12  | 209.165.200.225/27 |
| 1679424 | 1679424 |                                      |                    |
| 1       |         | 1 209.165.201.20/27<br>Ethernet3/12  | 209.165.200.225/27 |
| 1679424 | 1679424 |                                      |                    |
| 1       |         | 1209.165.201.19/27<br>Ethernet3/12   | 209.165.200.225/27 |
| 1679425 | 1679425 |                                      |                    |
| 1       |         | 1 209.165.201.18/27<br>Ethernet3/12  | 209.165.200.225/27 |
| 1679431 | 1679431 |                                      |                    |
| 1       |         | 1 209.165.201.17/27<br>Ethernet3/12  | 209.165.200.225/27 |
| 1679435 | 1679435 |                                      |                    |
| 1       |         | 1 209.165.201.16/27<br>Ethernet3/12  | 209.165.200.225/27 |

```

1679438 1679438
1 1 209.165.201.15/27 209.165.200.225/27
 Ethernet3/12
1679438 1679438
1 1 209.165.201.14/27 209.165.200.225/27
 Ethernet3/12
1679443 1679443
1 1 209.165.201.13/27 209.165.200.225/27
 Ethernet3/12
1679445 1679445
1 1 209.165.200.235/27 209.165.200.225/27
 Ethernet3/12
1679150 1679150
1 1 209.165.200.236/27 209.165.200.225/27
 Ethernet3/12
1679150 1679150
1 1 209.165.200.233/27 209.165.200.225/27
 Ethernet3/12
1679165 1679165
1 1 209.165.200.234/ 209.165.200.225/27 Ethernet3/12
1679151 1679151
1 1 209.165.200.231/ 209.165.200.225/27 Ethernet3/12
1679165 1679165
1 1 209.165.200.232/ 209.165.200.225/27 Ethernet3/12
1679165 1679165
1 1 209.165.200.229/ 209.165.200.225/27 Ethernet3/12
1679165 1679165
1 1 209.165.200.230/ 209.165.200.225/27 Ethernet3/12
1679165 1679165
1 1 209.165.200.227/ 209.165.200.225/27 Ethernet3/12
1679166 1679166
1 1 209.165.200.228/ 209.165.200.225/27 Ethernet3/12
1679166 1679166
1 1 209.165.201.12/2 209.165.200.225/27 Ethernet3/12
1679103 1679103
1 1 209.165.201.9/27 209.165.200.225/27 Ethernet3/12
1679112 1679112
1 1 209.165.201.10/2 209.165.200.225/27 Ethernet3/12
1679113 1679113
1 1 209.165.201.11/2 209.165.200.225/27 Ethernet3/12
1679113 1679113
.
.
.

```

This example shows how to view iCAM monitoring of the ACL TCAM resources for a current date.

```

switch# show icam resource acl-tcam module 3 inst 4

Feature Hardware Resource Utilization (Mod 3,Inst 4)

Ingress Resources

Feature TCAM# BANK# Feature_Entries Free_Entries Percent_Util Timestamp
(UTC)

PACL 0 0 4 4072 0.09 2017-09-05 22:05:28
CoPP 1 1 420 3656 10.25 2017-09-05 22:05:28
FEX Control 1 0 5 4071 0.12 2017-09-05 22:05:28

Egress Resources

Feature TCAM# BANK# Feature_Entries Free_Entries Percent_Util Timestamp

```

```

(UTC)

=====
ACL TCAM Resource Utilization (Mod 3,Inst 4)

 Used Free Percent_Util Timestamp (UTC)

Tcam 0 Bank 0 24 4072 0.58 2017-09-05 22:05:28
Tcam 0 Bank 1 20 4076 0.48 2017-09-05 22:05:28
Tcam 1 Bank 0 25 4071 0.61 2017-09-05 22:05:28
Tcam 1 Bank 1 440 3656 10.74 2017-09-05 22:05:28

```

This example shows how to view the history of iCAM monitoring of the ACL TCAM resources.

```

switch# show icam resource acl-tcam module 3 inst 4 history 2

Feature Hardware Resource Utilization (Mod 3,Inst 4)

Ingress Resources

 Feature TCAM# BANK# Feature_Entries Free_Entries Percent_Util Timestamp
 (UTC)

PACL 0 0 4 4072 0.09 2017-09-05 22:09:12
 4 4072 0.09 2017-09-05 23:09:12
CoPP 1 1 420 3656 10.25 2017-09-05 22:09:12
 420 3656 10.25 2017-09-05 23:09:12
FEX Control 1 0 5 4071 0.12 2017-09-05 22:09:12
 5 4071 0.12 2017-09-05 23:09:12

Egress Resources

 Feature TCAM# BANK# Feature_Entries Free_Entries Percent_Util Timestamp
 (UTC)

=====
ACL TCAM Resource Utilization (Mod 3,Inst 4)

 Used Free Percent_Util Timestamp (UTC)

Tcam 0 Bank 0 24 4072 0.58 2017-09-05 22:09:12
 24 4072 0.58 2017-09-05 23:09:12
Tcam 0 Bank 1 20 4076 0.48 2017-09-05 22:09:12
 20 4076 0.48 2017-09-05 23:09:12
Tcam 1 Bank 0 25 4071 0.61 2017-09-05 22:09:12
 25 4071 0.61 2017-09-05 23:09:12
Tcam 1 Bank 1 440 3656 10.74 2017-09-05 22:09:12
 440 3656 10.74 2017-09-05 23:09:12

```

This example shows how to view iCAM monitoring of the FIB TCAM resources for a current date.

```

switch# show icam resource fib-tcam module 3 inst 5

FIB TCAM Resource Utilization (Mod 3, Inst 5)

 Type logical physical Percent_Util Timestamp (UTC)

IPV4 unicast 16 16 0.02 2017-09-05 22:09:19
 DIAG 80 1 1 0.00 2017-09-05 22:09:19
IPV4 multicast 5005 5005 7.82 2017-09-05 22:09:19
 MPLS 0 0 0.00 2017-09-05 22:09:19
 EOM Peer 0 0 0.00 2017-09-05 22:09:19
 MPLS VPN 0 0 0.00 2017-09-05 22:09:19

```

|                |   |    |      |                     |
|----------------|---|----|------|---------------------|
| FCMPLS         | 0 | 0  | 0.00 | 2017-09-05 22:09:19 |
| FCOE           | 0 | 0  | 0.00 | 2017-09-05 22:09:19 |
| IPV6 LinkLocal | 1 | 2  | 0.00 | 2017-09-05 22:09:19 |
| IPV6 unicast   | 4 | 8  | 0.01 | 2017-09-05 22:09:19 |
| IPV6 multicast | 5 | 20 | 0.03 | 2017-09-05 22:09:19 |

This example shows how to view the history of the FIB TCAM resources monitored by iCAM.

```
switch# show icam resource fib-tcam module 3 inst 5 history 2
=====
FIB TCAM Resource Utilization (Mod 3, Inst 5)

```

| Type           | logical | physical | Percent_Util | Timestamp (UTC)     |
|----------------|---------|----------|--------------|---------------------|
| IPV4 unicast   | 16      | 16       | 0.02         | 2017-09-05 22:17:14 |
|                | 16      | 16       | 0.02         | 2017-09-05 23:17:14 |
| DIAG_80        | 1       | 1        | 0.00         | 2017-09-05 22:17:14 |
|                | 1       | 1        | 0.00         | 2017-09-05 23:17:14 |
| IPV4 multicast | 5005    | 5005     | 7.82         | 2017-09-05 22:17:14 |
|                | 5005    | 5005     | 7.82         | 2017-09-05 23:17:14 |
| MPLS           | 0       | 0        | 0.00         | 2017-09-05 22:17:14 |
|                | 0       | 0        | 0.00         | 2017-09-05 23:17:14 |
| EOM Peer       | 0       | 0        | 0.00         | 2017-09-05 22:17:14 |
|                | 0       | 0        | 0.00         | 2017-09-05 23:17:14 |
| MPLS VPN       | 0       | 0        | 0.00         | 2017-09-05 22:17:14 |
|                | 0       | 0        | 0.00         | 2017-09-05 23:17:14 |
| FCMPLS         | 0       | 0        | 0.00         | 2017-09-05 22:17:14 |
|                | 0       | 0        | 0.00         | 2017-09-05 23:17:14 |
| FCOE           | 0       | 0        | 0.00         | 2017-09-05 22:17:14 |
|                | 0       | 0        | 0.00         | 2017-09-05 23:17:14 |
| IPV6 LinkLocal | 1       | 2        | 0.00         | 2017-09-05 22:17:14 |
|                | 1       | 2        | 0.00         | 2017-09-05 23:17:14 |
| IPV6 unicast   | 4       | 8        | 0.01         | 2017-09-05 22:17:14 |
|                | 4       | 8        | 0.01         | 2017-09-05 23:17:14 |
| IPV6 multicast | 5       | 20       | 0.03         | 2017-09-05 22:17:14 |
|                | 5       | 20       | 0.03         | 2017-09-05 23:17:14 |

This example shows how to view the history of the FIB TCAM resources monitored by iCAM.

```
switch# show icam resource fib-tcam module 3 inst 5 history 4
=====
FIB TCAM Resource Utilization (Mod 3, Inst 5)

```

| Type          | logical | physical | Percent_Util | Timestamp (UTC)     |
|---------------|---------|----------|--------------|---------------------|
| IPV4 unicast  | 16      | 16       | 0.02         | 2017-09-05 22:13:13 |
|               | 16      | 16       | 0.02         | 2017-09-05 23:13:13 |
|               | 16      | 16       | 0.02         | 2017-09-06 00:13:14 |
|               | 16      | 16       | 0.02         | 2017-09-06 01:13:14 |
| DIAG_80       | 1       | 1        | 0.00         | 2017-09-05 22:13:13 |
|               | 1       | 1        | 0.00         | 2017-09-05 23:13:13 |
|               | 1       | 1        | 0.00         | 2017-09-06 00:13:14 |
|               | 1       | 1        | 0.00         | 2017-09-06 01:13:14 |
| IV4 multicast | 5005    | 5005     | 7.82         | 2017-09-05 22:13:13 |
|               | 5005    | 5005     | 7.82         | 2017-09-05 23:13:13 |
|               | 5005    | 5005     | 7.82         | 2017-09-06 00:13:14 |
|               | 5005    | 5005     | 7.82         | 2017-09-06 01:13:14 |
| MPLS          | 0       | 0        | 0.00         | 2017-09-05 22:13:13 |
|               | 0       | 0        | 0.00         | 2017-09-05 23:13:13 |
|               | 0       | 0        | 0.00         | 2017-09-06 00:13:14 |
|               | 0       | 0        | 0.00         | 2017-09-06 01:13:14 |
| EOM Peer      | 0       | 0        | 0.00         | 2017-09-05 22:13:13 |

|                |   |    |      |                     |
|----------------|---|----|------|---------------------|
|                | 0 | 0  | 0.00 | 2017-09-05 23:13:13 |
|                | 0 | 0  | 0.00 | 2017-09-06 00:13:14 |
|                | 0 | 0  | 0.00 | 2017-09-06 01:13:14 |
| MPLS VPN       | 0 | 0  | 0.00 | 2017-09-05 22:13:13 |
|                | 0 | 0  | 0.00 | 2017-09-05 23:13:13 |
|                | 0 | 0  | 0.00 | 2017-09-06 00:13:14 |
|                | 0 | 0  | 0.00 | 2017-09-06 01:13:14 |
| FCMPLS         | 0 | 0  | 0.00 | 2017-09-05 22:13:13 |
|                | 0 | 0  | 0.00 | 2017-09-05 23:13:13 |
|                | 0 | 0  | 0.00 | 2017-09-06 00:13:14 |
|                | 0 | 0  | 0.00 | 2017-09-06 01:13:14 |
| FCOE           | 0 | 0  | 0.00 | 2017-09-05 22:13:13 |
|                | 0 | 0  | 0.00 | 2017-09-05 23:13:13 |
|                | 0 | 0  | 0.00 | 2017-09-06 00:13:14 |
|                | 0 | 0  | 0.00 | 2017-09-06 01:13:14 |
| IPV6 LinkLocal | 1 | 2  | 0.00 | 2017-09-05 22:13:13 |
|                | 1 | 2  | 0.00 | 2017-09-05 23:13:13 |
|                | 1 | 2  | 0.00 | 2017-09-06 00:13:14 |
|                | 1 | 2  | 0.00 | 2017-09-06 01:13:14 |
| IPV6 unicast   | 4 | 8  | 0.01 | 2017-09-05 22:13:13 |
|                | 4 | 8  | 0.01 | 2017-09-05 23:13:13 |
|                | 4 | 8  | 0.01 | 2017-09-06 00:13:14 |
|                | 4 | 8  | 0.01 | 2017-09-06 01:13:14 |
| IPV6 multicast | 5 | 20 | 0.03 | 2017-09-05 22:13:13 |
|                | 5 | 20 | 0.03 | 2017-09-05 23:13:13 |
|                | 5 | 20 | 0.03 | 2017-09-06 00:13:14 |
|                | 5 | 20 | 0.03 | 2017-09-06 01:13:14 |

This example displays the predictive analytics of the ACL TCAM resources.

```
switch# show icam prediction resource acl-tcam module 3 inst 4 2018 Jan 27 11:35:30
Generating predictions, this may take some time ...
```

```

Feature Hardware Resource Prediction (Mod 3,Inst 4)

```

```

Feature Direction TCAM# BANK# Feature_Entries Free_Entries
Percent_Util

```

```
0.00 PACL ingress 0 0 4 4072
0.00 FEX Control ingress 1 0 5 4071
10.00 CoPP ingress 1 1 420 3656
```

```
=====
ACL TCAM Resource Prediction (Mod 3,Inst 4)

```

```
Used Free Percent_Util

```

```

Tcam 1 Bank 1 440 3656 10.74
Tcam 1 Bank 0 25 4071 0.61
Tcam 0 Bank 1 20 4076 0.48
Tcam 0 Bank 0 24 4072 0.58
```

This example displays the predictive analytics of the FIB TCAM resources.

```
switch# show icam prediction resource fib-tcam module 3 inst 5 2025 Dec 20 10:20:37
Generating predictions, this may take some time ...
```

```
=====
FIB TCAM Resource Prediction (Mod 3, Inst 5)

Type logical physical Percent_Util

FCMPLS 0 0 0.00
IPV4 unicast 16 16 0.00
 DIAG_80 1 1 0.00
 EOM Peer 0 0 0.00
 MPLS 0 0 0.00
IPV6 multicast 5 20 0.00
IPV6 LinkLocal 1 2 0.00
 FCOE 0 0 0.00
 MPLS VPN 0 0 0.00
IPV4 multicast 5005 5005 7.00
IPV6 unicast 4 8 0.00
```

## 21.13 Example: Obtaining JSON Outputs for iCAM Configurations

This example shows how to view top 1% TCAM entries for a current date in JSON format.

```
switch# show icam entries acl module 5 inst 0 sort top 1 | json
{"module": 5,
 "instance": 0,
 "TABLE_ACL_entries": {
 "ROW_ACL_entries": [
 {
 "Feature": "QoS COPP",
 "Pkt_Type": "IPv4",
 "SourceIP_Mask_DestIP_Mask": "ip 0.0.0.0/0 0.0.0.0/0",
 "Action": "QoS",
 "ifindex": "0x0"
 "Stats": 2637573806
 },
 {
 "Feature": "RACL",
 "Pkt_Type": "IPv4",
 "SourceIP_Mask_DestIP_Mask": "ip 209.165.201.1/27 209.165.201.2/27",
 "Action": "Permit",
 "ifindex": "0x1a200000"
 "Stats": 1247078657
 },
 {
 "Feature": "QoS COPP",
 "Pkt_Type": "IPv4",
 "SourceIP_Mask_DestIP_Mask": "ip 0.0.0.0/0 0.0.0.0/0",
 "Action": "QoS",
 "ifindex": "0x0"
 "Stats": 745341269
 },
 {
 "Feature": "RACL",
 "Pkt_Type": "IPv4",
 "SourceIP_Mask_DestIP_Mask": "ip 209.165.201.3/27 209.165.201.4/27",
 "Action": "Permit",
 "ifindex": "0x1a200000"
 "Stats": 745341269
 }
]
}
```

```
}
}
```

This example shows how to view top 10% multicast entries for a current date in JSON format.

```
switch# show icam entries multicast module 5 sort top 10 | json
{
 "module": 5,
 "TABLE_MULTICAST_entries": {
 "ROW_ACL_entries":
 { "Vdc": 1,
 "Table_Id": 1,
 "Source_Mask": "209.165.201.18/27",
 "Group_Mask": "209.165.201.10/27",
 "Rpf": "Ethernet5/2"
 "Stats": 5318470244
 }
 }
}
```

This example shows how to view iCAM monitoring of the ACL TCAM resources for a current date in JSON format.

```
switch# show icam resource acl_tcam module 5 inst 0 | json
{
 "module": 5,
 "instance": 0,
 "TABLE_feature_resource": {
 "ROW_feature_resource": [
 {
 "Feature": "CoPP",
 "TCAM": 1,
 "BANK": 1,
 "TABLE_ingress_stats":
 { "ROW_ingress_stats": {
 "Feature_Entries": 442,
 "Free_Entries": 32306,
 "Percent_Util": 1.34,
 "Timestamp": "2017-08-09 14:36:19"
 }
 }
 },
 {
 "Feature": "FEX Control",
 "TCAM": 1,
 "BANK": 0,
 "TABLE_ingress_stats":
 { "ROW_ingress_stats": {
 "Feature_Entries": 5,
 "Free_Entries": 32733,
 "Percent_Util": 0.01,
 "Timestamp": "2017-08-09 14:36:19"
 }
 }
 }
],
 {
 "Feature": "RACL",
 "TCAM": 1,
 "BANK": 0,
 "TABLE_ingress_stats":
 { "ROW_ingress_stats": {
 "Feature_Entries": 10,
 "Free_Entries": 32733,
 "Percent_Util": 0.03,
 "Timestamp": "2017-08-09 14:36:19"
 }
 }
 }
 }
}
```

```

 }
]
},
"mod": 5,
"inst": 0,
"TABLE_tcam_bank_utilization": {
 "ROW_tcam_bank_utilization": {
 {
 "Tcam_no": "Tcam 0",
 "Bank_no": "Bank 0",
 "TABLE_tcam_bank_stats": {
 "ROW_tcam_bank_stats": {
 { "Used": 20,
 "Free": 32748,
 "Percent_Util": 0.06,
 "Timestamp": "2017-08-09 14:36:19"
 }
 }
 },
 {
 "Tcam_no": "Tcam 0",
 "Bank_no": "Bank 1",
 "TABLE_tcam_bank_stats": {
 "ROW_tcam_bank_stats": {
 { "Used": 20,
 "Free": 32748,
 "Percent_Util": 0.06,
 "Timestamp": "2017-08-09 14:36:19"
 }
 }
 }
 },
 {
 "Tcam_no": "Tcam 1",
 "Bank_no": "Bank 0",
 "TABLE_tcam_bank_stats": {
 "ROW_tcam_bank_stats": {
 { "Used": 35,
 "Free": 32733,
 "Percent_Util": 0.1,
 "Timestamp": "2017-08-09 14:36:19"
 }
 }
 }
 },
 {
 "Tcam_no": "Tcam 1",
 "Bank_no": "Bank 1",
 "TABLE_tcam_bank_stats": {
 "ROW_tcam_bank_stats": {
 { "Used": 462,
 "Free": 32306,
 "Percent_Util": 1.4,
 "Timestamp": "2017-08-09 14:36:19"
 }
 }
 }
 }
 }
]
}
}

```

This example shows how to view iCAM monitoring of the FIB TCAM resources for a current date in JSON format.

```

switch# show icam resource fib_tcam module 5 inst 0 | json
{

```



```

"module": 5,
"instance": 0,
"TABLE_fib_resource": {
 "ROW_fib_resource": [
 {
 "Class": "IPv4 unicast",
 "TABLE_fib_stats": {
 { "ROW_fib_stats": {
 "Log_Entries": 16,
 "Phy_Entries": 16,
 "Percent_Util": 0.0,
 "Timestamp": "2017-08-09 14:37:59"
 }
 }
 },
 {
 "Class": "DIAG_80",
 "TABLE_fib_stats": {
 { "ROW_fib_stats": {
 "Log_Entries": 0,
 "Phy_Entries": 0,
 "Percent_Util": 0.0,
 "Timestamp": "2017-08-09 14:37:59"
 }
 }
 },
 {
 "Class": "IPv4 unicast",
 "TABLE_fib_stats": {
 { "ROW_fib_stats": {
 "Log_Entries": 6,
 "Phy_Entries": 6,
 "Percent_Util": 0.0,
 "Timestamp": "2017-08-09 14:37:59"
 }
 }
 }
]
}
}
}

```

## 21.14 Additional References for iCAM

### Related Documents

| Related Topic     | Document Title                                                        |
|-------------------|-----------------------------------------------------------------------|
| Command Reference | <i>Inspur CN12700 Series INOS System Management Command Reference</i> |

# CHAPTER 22 Performing Software Maintenance Upgrades

This chapter describes how to perform software maintenance upgrades on Inspur INOS devices. This chapter contains the following sections:

- Prerequisites for SMUs
- Guidelines and Limitations for SMUs
- Information About Performing a Software Maintenance Upgrades
- Performing a Software Maintenance Upgrade for Inspur INOS
- Where to Go Next
- Additional References
- Feature Information for Performing Software Maintenance Upgrades

## 22.1 Prerequisites for SMUs

These prerequisites must be met for a package to be activated or deactivated:

- You must be in a user group associated with a task group that includes the proper task IDs. If you suspect a user group assignment is preventing you from using a command, contact your AAA administrator for assistance.
- Verify that all line cards are installed and operating properly. For example, do not activate or deactivate packages while line cards are booting, while line cards are being upgraded or replaced, or when you anticipate an automatic switchover activity.
- In a dual-supervisor system, both the active and standby supervisor modules have to be synchronized with each other.

## 22.2 Guidelines and Limitations for SMUs

SMUs have the following guidelines and limitations:

- Some packages require the activation or deactivation of other packages. If the SMUs have dependencies on each other, you cannot activate them without first activating the previous ones.
- The package being activated must be compatible with the current active software set.
- You cannot activate multiple SMUs in one command.
- Per-VDC SMUs are not supported.
- Activation is performed only after the package compatibility checks have been passed. If a conflict is found, an error message displays.
- While a software package is being activated, other requests are not allowed to run on any of the impacted nodes. Package activation is completed when a message similar to this one appears:  
Install operation 1 completed successfully at Thu Jan 9 01:19:24 2014
- Each CLI install request is assigned a request ID, which can be used later to review the events.
- SMUs are dependent on your physical device. So, an SMU will not work for the Inspur CN12700 Series and vice versa.
- If you perform a software maintenance upgrade and later upgrade your device to a new Inspur INOS software release, the new image will overwrite both the previous Inspur INOS release and the SMU package file.
- SMUs are dependent on the version of Inspur INOS software release installed. You need to install SMUs compatible with your release. Moving to another Inspur INOS software release using reload or ISSU will inactivate the SMUs installed for the previously installed Inspur INOS software release. For example, if you have SMUs for Inspur INOS Release 7.2.0 in your Supervisor 2 setup, moving to an image of another release, say Inspur INOS Release 7.2.2 will cause the SMU to become inactive.

- SMU will be deactivated if you are loading an image of the Inspur INOS software release prior to INOS Release 7.2.0 that does not support SMUs. However, moving back to Inspur INOS Release 7.2.0 will activate the SMU.

## 22.3 Information About Performing a Software Maintenance Upgrades

### 22.3.1 Overview of SMUs

Typically, SMUs do not have a large impact on device operations. SMU versions are synchronized to the package major, minor, and maintenance versions they upgrade.

SMUs are not an alternative to maintenance releases. They provide a quick resolution of immediate issues. All defects fixed by SMUs are integrated into the maintenance releases.

Actual deployment of SMUs might vary based on your device. Usually, software can be patched simply by restarting the process. However, based on the device, if the process to be patched cannot be restarted, the SMU is implemented either through a reload or ISSU.

The effect of an SMU depends on its type:

- Process restart SMU—Causes a process or group of processes to restart on activation.
- Reload SMU—Causes a reload of the whole switch and a parallel reload of supervisors and line cards.
- Line card SMU—Based on the line card type. The supervisor pushes the SMU to all impacted line cards.

Activation of the line card SMU requires a reload of the switch.

- Prerequisite SMU—Requires activation before a dependent SMU is loaded. A SMU can have one or more SMU as prerequisites.

- Supersede SMU— Contains cumulative fix for previously loaded SMUs and supersedes the former.

For information on upgrading your device to a new feature or maintenance release, see the *Inspur CN12700 Series INOS Software Upgrade and Downgrade Guide*.

An SMU consists of the SMU binary file. The naming convention for an SMU is as below:

`<platform>-<pkg-type>.<release_version>.<CDET>.<file-type>`

For example:

CN12700-s2-dk9.7.2.0.D1.1.CSCuo07721.bin

### 22.3.2 Package Management

The general procedure for adding and activating SMU packages on the device is as follows:

1. Copy the package file or files to a local storage device or file server.
2. Add the package or packages on the device using the install add command.
3. Activate the package or packages on the device using the install activate command.
4. (Optional) Deactivate and remove the package, when desired.

The following figure illustrates the key steps in the package management process.

Figure 17 Process to Add, Activate, and Commit SMU Packages

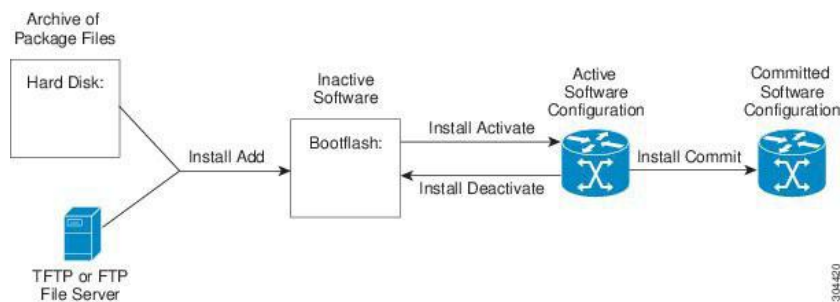

## 22.3.3 Impact of Package Activation and Deactivation

The activation or deactivation of an SMU package can have an immediate impact on the system. The system can be affected in the following ways:

- New processes might be started.
- Running processes might be stopped or restarted.
- All processes on the line cards can be patched and only those processes that can be restarted are restarted.

Restarting processes in the line cards are equivalent to a soft reset.

- For line card SMUs, the system behaves as if it were going through an upgrade.
- The line cards might reload.
- The complete system might reload.
- No processes in the line cards might be affected.

|            |                                                                                                                                                                                                                                   |
|------------|-----------------------------------------------------------------------------------------------------------------------------------------------------------------------------------------------------------------------------------|
| <b>Tip</b> | When you activate packages, use the test option to test the effects of a command without impacting the running system. After the activation process completes, enter the show install log command to display the process results. |
|------------|-----------------------------------------------------------------------------------------------------------------------------------------------------------------------------------------------------------------------------------|

## 22.4 Performing a Software Maintenance Upgrade for Inspur INOS

### 22.4.1 Preparing for Package Installation

You should use several show commands to gather information in preparation for the SMU package installation.

#### Before you begin

Determine if a software change is required.

Verify that the new package is supported on your system. Some software packages require that other packages or package versions be activated, and some packages support only specific line cards.

Review the release notes for important information related to that release and to help determine the package compatibility with your device configuration.

Verify that the system is stable and prepared for the software changes.

#### Procedure

|        | Command or Action                                                                                                                  | Purpose                                                                                                                 |
|--------|------------------------------------------------------------------------------------------------------------------------------------|-------------------------------------------------------------------------------------------------------------------------|
| Step 1 | <b>show install active</b><br><b>Example:</b><br>switch# show install active                                                       | Displays the active software on the device. Use this command to determine what software should be added on the device.  |
| Step 2 | <b>show module</b><br><b>Example:</b><br>switch# show module                                                                       | Confirms that all modules are in the stable state.                                                                      |
| Step 3 | <b>show clock</b><br><b>Example:</b><br>switch# show clock                                                                         | Verifies that the system clock is correct. Software operations use certificates based on device clock times.            |
| Step 4 | <b>show install pkg-info SMU_name</b><br><b>Example:</b><br>Device# show install pkg-info CN12700-s2-dk9.7.2.0.D1.1.CSCuo07721.bin | Displays details regarding the contents of the SMU, that is, SMU restart type, platform, processes affected, and so on. |

#### Example

This example shows how to display the active packages for the entire system. Use this information to determine if a software change is required.

Before SMU installation:

```
switch# show install active

Boot Images:

Kickstart Image: bootflash:/ CN12700-s2-kickstart.7.2.0.D1.1.bin
System Image: bootflash:/ CN12700-s2-dk9.7.2.0.D1.1.bin

Active Packages:
Active Packages on Module #1:
```

After SMU installation:

```
Switch# show install active

Boot Images:

Kickstart Image: bootflash:/CN12700-s2-kickstart.7.2.0.D1.1.bin
System Image: bootflash:/CN12700-s2-dk9.7.2.0.D1.1.bin

Active Packages:

CN12700-s2-dk9.7.2.0.D1.1.CSCuo7721.bin

Active Packages on Module #1:
CN12700-s2-dk9.7.2.0.D1.1.CSCuo7721.bin
```

This example shows how to display the current system clock setting:

```
switch# show clock

02:14:51.474 PST Wed Jan 04 2014
```

This example shows how to display details of the installed package. Use this information to determine if a software change is required.

```
switch# show install pkg-info CN12700-s2-dk9.7.2.0.D1.1. CSCuo07721.bin

Contents of Package file 'CN12700-s2-dk9.7.2.0.D1.1.CSCuo07721.bin'
Expiry date: Sun Oct 22 11:39:35 2017
Uncompressed size: 224905
Vendor: Inspur Systems
Restart type: restart
Desc: Bug Fix for CDET: CSCuo07721 Build:
Built on Tue Aug 4 01:12:10 2015 Source: By
Unknown
Platform: CN12700
Supersedes: None
Superseded By: None
Pre-requisite: None
Restart information: Ethpm
Pre-install activate scripts: None
Post-install activate scripts: None
Pre-install deactivate scripts: None
Post-install deactivate scripts: None
```

## 22.4.2 Downloading the SMU Package File from Inspur.com Copying the Package File to a Local Storage Device or Network Server

You must copy the SMU package file to a local storage device or a network file server to which the device has access. After this task is done, the package can be added and activated on the device.

If you need to store package files on the device, we recommend that you store the files on the hard disk. The boot device is the local disk from which the package is added and activated. The default boot device is bootflash:.

|            |                                                                                                                                                                 |
|------------|-----------------------------------------------------------------------------------------------------------------------------------------------------------------|
| <b>TiP</b> | Before you copy package files to a local storage device, use the <code>dir</code> command to determine if the required package files are already on the device. |
| <b>TiP</b> | Verify there is enough space on the bootflash.                                                                                                                  |

If the SMU package files are located on a remote TFTP, FTP, SCP, or SFTP server, you can copy the files to a local storage device. After the files are located on the local storage device, the package can be added and activated on the device from that storage device. The following server protocols are supported:

- Trivial File Transfer Protocol—TFTP allows files to be transferred from one computer to another over a network, usually without the use of client authentication (for example, username and password). It is a simplified version of FTP.
- File Transfer Protocol—FTP is part of the TCP/IP protocol stack and requires a username and password.
- Secure Copy—SCP allows files to be transferred from a network server that supports Secure Shell (SSH) and uses the secure copy protocol(SCP).
- SSH File Transfer Protocol—SFTP is part of the SSHv2 feature in the security package and provides for secure file transfers. For more information, see the *Inspur CN12700 Series INOS Security Configuration Guide*.

Use the commands in the following table to copy the SMU package file from the server to your device using the file transfer protocols.

Table 42 Commands for Copying SMU Package Files to the Device

| Command                                                                                                                                                                                                   | Purpose                                                                                                                                                                                                                                                                                                                                                                                                                                                                                                                                                                                                                                                                                                                                                                                                                                                                                                                                                                                                                                                                                                    |
|-----------------------------------------------------------------------------------------------------------------------------------------------------------------------------------------------------------|------------------------------------------------------------------------------------------------------------------------------------------------------------------------------------------------------------------------------------------------------------------------------------------------------------------------------------------------------------------------------------------------------------------------------------------------------------------------------------------------------------------------------------------------------------------------------------------------------------------------------------------------------------------------------------------------------------------------------------------------------------------------------------------------------------------------------------------------------------------------------------------------------------------------------------------------------------------------------------------------------------------------------------------------------------------------------------------------------------|
| <b>copy tftp://hostname-or-ipaddress/directory-path/filename bootflash:</b><br>switch# copy tftp://10.1.1.1/images/<br>CN12700-s2-dk9.7.2.0.D1.1.CSCuo07721.bin<br>bootflash:                             | Copies the package file from the TFTP server to the bootflash:. <ul style="list-style-type: none"> <li>• <i>hostname-or-ipaddress</i>—The hostname or IP address of the network file server.</li> <li>• <i>directory-path</i>—The network file server path that leads to the package file to be added.</li> <li>• <i>filename</i>—The name of the package file that you want to add.</li> </ul>                                                                                                                                                                                                                                                                                                                                                                                                                                                                                                                                                                                                                                                                                                            |
| <b>copy ftp://username:password@hostname-or-ipaddress/directory-path/filename bootflash:</b><br>switch# copy ftp://john:secret@10.1.1.1/images/<br>CN12700-s2-dk9.7.2.0.D1.1.CSCuo07721.bin<br>bootflash: | Copies the package file from the FTP server to the bootflash:. <ul style="list-style-type: none"> <li>• <i>username</i>—The username of the user who has access privileges to the directory in which the package file is stored.</li> <li>• <i>password</i>—The password associated with the username of the user who has access privileges to the directory in which the package file is stored. If a password is not provided, the networking device accepts anonymous FTP.</li> <li>• <i>hostname-or-ipaddress</i>—The hostname or IP address of the network file server.</li> <li>• <i>directory-path</i>—The network file server path that leads to the package file to be added. The specified directory should be a directory under the home directory of the user. In this example, the file being downloaded is in a subdirectory called "images" in the home directory of the user "john."</li> </ul> <p><b>Note</b> For FTP services, <i>directory-path</i> is the directory relative to the <i>username</i> home directory. If you want to specify an absolute path for the directory, you</p> |

| Command                                                                                                                                                                                                                                                                  | Purpose                                                                                                                                                                                                                                                                                                                                                                                                                               |
|--------------------------------------------------------------------------------------------------------------------------------------------------------------------------------------------------------------------------------------------------------------------------|---------------------------------------------------------------------------------------------------------------------------------------------------------------------------------------------------------------------------------------------------------------------------------------------------------------------------------------------------------------------------------------------------------------------------------------|
|                                                                                                                                                                                                                                                                          | <p>must add a “/” following the server address.</p> <ul style="list-style-type: none"> <li><i>filename</i>—The name of the package file that you want to add.</li> </ul>                                                                                                                                                                                                                                                              |
| <p><b>copy sftp://hostname-or-ipaddress/directory-path/filename</b><br/> <b>bootflash:</b><br/> switch# copy<br/> sftp://10.1.1.1/images<br/> CN12700-s2-dk9.7.2.0.D1.1.CSCuo07721.bin<br/> bootflash:</p>                                                               | <p>Copies the package file from the SFTP server to the bootflash:.</p> <ul style="list-style-type: none"> <li><i>username</i>—The username of the user who has access privileges to the directory in which the package file is stored.</li> <li><i>directory-path</i>—The network file server path that leads to the package file to be added.</li> <li><i>filename</i>—The name of the package file that you want to add.</li> </ul> |
| <p><b>copy</b><br/> <b>scp://username@scpserver.Inspur.com//directory-path/filename</b><br/> <b>bootflash:</b><br/> switch# copy<br/> scp://john@10.1.1.1//download/CN12700-s2-dk9.7.2.0.D1.1.CSCuo07721.bin<br/> bootflash:CN12700-s2-dk9.7.2.0.D1.1.CSCuo07721.bin</p> | <p>Copies the package file from the SCP server to the bootflash:.</p> <ul style="list-style-type: none"> <li><i>hostname-or-ipaddress</i>—The hostname or IP address of the network file server.</li> <li><i>directory-path</i>—The network file server path that leads to the package file to be added.</li> <li><i>filename</i>—The name of the package file that you want to add.</li> </ul>                                       |

After the SMU package file has been transferred to a network file server or the local storage device, you are ready to add and activate the file.

### 22.4.3 Adding and Activating Packages

You can add SMU package files that are stored on a local storage device or on a remote TFTP, FTP, or SFTP server to your device.

#### Before you begin

Make sure that all packages to be added are present on a local storage device or a network file server. Make sure that you meet all of the prerequisites for the activation of packages.

#### Procedure

|               | Command or Action                                                                                                                                    | Purpose                                                                                                                                                                                                                                                        |
|---------------|------------------------------------------------------------------------------------------------------------------------------------------------------|----------------------------------------------------------------------------------------------------------------------------------------------------------------------------------------------------------------------------------------------------------------|
| <b>Step 1</b> | Connect to the console port and log in.                                                                                                              | Establishes a CLI management session to the console port.                                                                                                                                                                                                      |
| <b>Step 2</b> | (Optional) <b>dir bootflash:</b>                                                                                                                     | <p>Displays the package files that are available to be added.</p> <p><b>Note</b> Only SMU package files can be added and activated using this procedure.</p>                                                                                                   |
| <b>Step 3</b> | <p><b>install add filename [activate]</b><br/> <b>Example:</b><br/> switch# install add bootflash:<br/> CN12700-s2-dk9.7.2.0.D1.1.CSCuo07721.bin</p> | <p>Unpacks the package software files from the local storage device or network server and adds them to the bootflash: on active and standby supervisors.</p> <p>Installs the SMU code from the local storage device or network server and adds them to the</p> |

|               | Command or Action                                                                                                                                                                                                                    | Purpose                                                                                                                                                                                                                                                                                                                                                                                                                                                                                                                                                                                                                                                                                                                                                                                                                                                                                                                                                                                                                                                                                                                                                         |
|---------------|--------------------------------------------------------------------------------------------------------------------------------------------------------------------------------------------------------------------------------------|-----------------------------------------------------------------------------------------------------------------------------------------------------------------------------------------------------------------------------------------------------------------------------------------------------------------------------------------------------------------------------------------------------------------------------------------------------------------------------------------------------------------------------------------------------------------------------------------------------------------------------------------------------------------------------------------------------------------------------------------------------------------------------------------------------------------------------------------------------------------------------------------------------------------------------------------------------------------------------------------------------------------------------------------------------------------------------------------------------------------------------------------------------------------|
|               |                                                                                                                                                                                                                                      | <p>bootflash: on the active and standby supervisor. After the <b>install add</b> process, the SMU patch still requires activation as described in steps 4-7.</p> <p>The <i>filename</i> argument can take any of these formats:</p> <ul style="list-style-type: none"> <li>• <b>bootflash:</b><i>filename</i></li> <li>• <b>tftp://</b><i>hostname-or-ipaddress/directory-path/filename</i></li> <li>• <b>ftp://</b><i>username:password@hostname-or-ipaddress/directory-path/filename</i></li> <li>• <b>sftp://</b><i>hostname-or-ipaddress/directory-path/filename</i></li> <li>• <b>usb1:</b><i>filename</i></li> </ul> <p>Multiple versions of an SMU package can be added to the storage device without impacting the currently running software, but only one version of a package can be activated.</p> <p><b>Note</b> Though the <b>install add</b> function copies the SMU code to any standby supervisor present in the system, it does not copy the SMU .bin file to a standby supervisor bootflash, as the SMU .bin file is not required on both active and standby bootflash. It can manually be copied to the standby bootflash, if required.</p> |
| <b>Step 4</b> | <p>(Optional) <b>show install inactive</b></p> <p><b>Example:</b><br/>switch# show install inactive</p>                                                                                                                              | <p>Displays the inactive packages on the device. Verify that the package added in the previous step appears in the display.</p>                                                                                                                                                                                                                                                                                                                                                                                                                                                                                                                                                                                                                                                                                                                                                                                                                                                                                                                                                                                                                                 |
| <b>Step 5</b> | <p>Required: <b>install activate filename [test]</b></p> <p><b>Example:</b><br/>switch# install activate CN12700-s2-dk9.7.2.0.D1.1.CSCuo07721.bin</p> <p>Install operation 158 completed successfully at Tue Jun 9 19:09:33 2015</p> | <p>Activates a package that was added to the device. SMU packages remain inactive until activated. (Skip this step if the package was activated earlier with the <b>install add activate</b> command.)</p> <p><b>Note</b> Press ? after a partial package name to display all possible matches available for activation. If there is only one match, press the <b>Tab</b> key to fill in the rest of the package name.</p> <p><b>Tip</b> When you activate packages, use the <b>test</b> keyword to test the effects of a command without impacting the running system. After the activation process finishes, enter the <b>show install log</b> command to display the process results.</p>                                                                                                                                                                                                                                                                                                                                                                                                                                                                    |
| <b>Step 6</b> | Repeat Step 5 until all packages are activated.                                                                                                                                                                                      | Activates additional packages as required.                                                                                                                                                                                                                                                                                                                                                                                                                                                                                                                                                                                                                                                                                                                                                                                                                                                                                                                                                                                                                                                                                                                      |
| <b>Step 7</b> | <p>(Optional) <b>show install active</b></p> <p><b>Example:</b><br/>switch# show install active</p>                                                                                                                                  | Displays all active packages. Use this command to determine if the correct packages are active.                                                                                                                                                                                                                                                                                                                                                                                                                                                                                                                                                                                                                                                                                                                                                                                                                                                                                                                                                                                                                                                                 |



## 22.4.4 Committing the Active Package Set

When an SMU package is activated on the device, it becomes part of the current running configuration. To make the package activation persistent across system-wide reloads, you must commit the package on the device.

### Before you begin

Before you commit a package set, verify that the device is operating correctly and is forwarding packets as expected.

### Procedure

|        | Command or Action                                                                                                              | Purpose                                                                                         |
|--------|--------------------------------------------------------------------------------------------------------------------------------|-------------------------------------------------------------------------------------------------|
| Step 1 | <b>install commit</b> <i>filename</i><br><b>Example:</b><br>switch# install commit<br>CN12700-s2-dk9.7.2.0.D1.1.CSCuo07721.bin | Commits the current set of packages so that these packages are used if the device is restarted. |
| Step 2 | (Optional) <b>show install committed</b><br><b>Example:</b><br>switch# show install committed                                  | Displays which packages are committed.                                                          |

### Example

This example shows how to commit active SMU packages on the device and then verify the committed packages:

```
switch# install commit CN12700-s2-dk9.7.2.0.D1.1.CSCuo07721.bin
Install operation 2 completed successfully at Thu Jan 9 01:20:46 2014
switch# show install committed
Boot Images:
 Kickstart Image: bootflash:/CN12700-s2-
kickstart.7.2.0.D1.1.bin System Image: bootflash:/ CN12700-
s2-dk9.7.2.0.D1.1.bin
Committed Packages:
 CN12700-s2-dk9.7.2.0.D1.1.CSCuo07721.bin
```

## 22.4.5 Deactivating and Removing Packages

When a package is deactivated, it is no longer active on the device, but the package files remain on the boot disk. The package files can be reactivated later, or they can be removed from the disk.

The Inspur INOS software also provides the flexibility to roll back the selected package set to a previously saved package set. If you find that you prefer a previous package set over the currently active package set, you can use the install deactivate and install commit commands to deactivate the current package and install active and install commit commands to activate the previous package.

### Before you begin

You cannot deactivate a package if it is required by another active package. When you attempt to deactivate a package, the system runs an automatic check to ensure that the package is not required by other active packages. The deactivation is performed only after all compatibility checks have been passed.

You cannot delete a package if it is part of the running or committed software of the device.

### Procedure

|        | Command or Action                       | Purpose                                                   |
|--------|-----------------------------------------|-----------------------------------------------------------|
| Step 1 | Connect to the console port and log in. | Establishes a CLI management session to the console port. |

|        | Command or Action                                                                                                                                                                                                                                                                                                                    | Purpose                                                                                                                                                                                                                                                                                                                                                                                                                                                                                                                                                                              |
|--------|--------------------------------------------------------------------------------------------------------------------------------------------------------------------------------------------------------------------------------------------------------------------------------------------------------------------------------------|--------------------------------------------------------------------------------------------------------------------------------------------------------------------------------------------------------------------------------------------------------------------------------------------------------------------------------------------------------------------------------------------------------------------------------------------------------------------------------------------------------------------------------------------------------------------------------------|
| Step 2 | <b>install deactivate</b> <i>filename</i><br><b>Example:</b><br>switch# install deactivate<br>CN12700-s2-dk9.7.2.0.D1.1.CSCuo07721.bin                                                                                                                                                                                               | Deactivates a package that was added to the device and turns off the package features for the line card.<br><b>Note</b> Press <b>?</b> after a partial package name to display all possible matches available for deactivation. If there is only one match, press the <b>Tab</b> key to fill in the rest of the package name.                                                                                                                                                                                                                                                        |
| Step 3 | (Optional) <b>show install inactive</b><br><b>Example:</b><br>switch# show install inactive                                                                                                                                                                                                                                          | Displays the inactive packages on the device.                                                                                                                                                                                                                                                                                                                                                                                                                                                                                                                                        |
| Step 4 | (Optional) <b>install commit</b><br><b>Example:</b><br>switch# install commit                                                                                                                                                                                                                                                        | Commits the current set of packages so that these packages are used if the device is restarted.<br><b>Note</b> Packages can be removed only if the deactivation operation is committed.                                                                                                                                                                                                                                                                                                                                                                                              |
| Step 5 | (Optional) <b>install remove</b> <i>{filename   inactive}</i><br><b>Example:</b><br>switch# install remove CN12700-s2-dk9.7.2.0.D1.1.CSCuo07721.bin<br>Proceed with removing CN12700-s2-dk9.7.2.0.D1.1.CSCuo07721.bin? (y/n)?<br>[n] y<br><br><b>Example:</b><br>switch# install remove inactive Proceed with removing? (y/n)? [n] y | Removes the inactive package. <ul style="list-style-type: none"> <li>• Only inactive packages can be removed.</li> <li>• Packages can be removed only if they are deactivated from all line cards in the device.</li> <li>• The package deactivation must be committed.</li> <li>• To remove a specific inactive package from a storage device, use the <b>install remove</b> command with the <i>filename</i> argument.</li> <li>• To remove all inactive packages from all nodes in the system, use the <b>install remove</b> command with the <b>inactive</b> keyword.</li> </ul> |

### Example

This example shows how to deactivate a package, commit the changes, and remove the inactive package from the device:

```
switch# install deactivate CN12700-s2-dk9.7.2.0.D1.1.CSCuo07721.bin
Install operation 3 completed successfully at Thu Jan 9 01:20:36 2014

switch# show install inactive
Inactive Packages: CN12700-s2-dk9.7.2.0.D1.1.CSCuo07721.bin

switch# install commit
Install operation 4 completed successfully at Thu Jan 9 01:20:46 2014

switch# install remove CN12700-s2-dk9.7.2.0.D1.1.CSCuo07721.bin
Proceed with removing CN12700-s2-dk9.7.2.0.D1.1.CSCuo07721.bin? (y/n)? [n]
y Install operation 5 completed successfully at Thu Jan 9 01:20:57 2014
```

## 22.4.6 Displaying Installation Log Information

The installation log provides information on the history of the installation operations. Each time an installation operation is run, a number is assigned to that operation.

- Use the show install log command to display information about both successful and failed installation operations.

- Use the show install log command with no arguments to display a summary of all installation operations. Specify the request-id argument to display information specific to an operation. Use the detail keyword to display details for a specific operation, including file changes, nodes that could not be reloaded, and any impact to processes.

This example shows how to display information for all installation requests:

```
switch# show install log
Thu Jan 9 01:26:09 2014
Install operation 1 by user 'admin' at Thu Jan 9 01:19:19 2014
Install add bootflash: CN12700-s2-dk9.7.2.0.D1.1.CSCuo07721.bin
Install operation 1 completed successfully at Thu Jan 9 01:19:24 2014

Install operation 2 by user 'admin' at Thu Jan 9 01:19:29 2014
Install activate CN12700-s2-dk9.7.2.0.D1.1.bin
Install operation 2 completed successfully at Thu Jan 9 01:19:45 2014

Install operation 3 by user 'admin' at Thu Jan 9 01:20:05 2014
Install commit CN12700-s2- dk9.7.2.0.D1.1.bin
Install operation 3 completed successfully at Thu Jan 9 01:20:08 2014

Install operation 4 by user 'admin' at Thu Jan 9 01:20:21 2014
Install deactivate CN12700-s2-dk9.7.2.0.D1.1.bin
Install operation 4 completed successfully at Thu Jan 9 01:20:36 2014

Install operation 5 by user 'admin' at Thu Jan 9 01:20:43 2014
Install commit CN12700-s2-dk9.7.2.0.D1.1.bin
Install operation 5 completed successfully at Thu Jan 9 01:20:46 2014

Install operation 6 by user 'admin' at Thu Jan 9 01:20:55 2014
Install remove CN12700-s2-dk9.7.2.0.D1.1.bin
Install operation 6 completed successfully at Thu Jan 9 01:20:57 2014

Install operation 7 by user 'admin' at Thu Jan 9 01:21:07 2014
Install remove
Install operation 7 completed successfully at Thu Jan 9 01:21:10 201
```

This example shows how to display additional information, including any impact to nodes and processes:

```
switch# show install log detail
Thu Jan 9 01:24:03 2014
Install operation 1 by user 'admin' at Thu Jan 9 01:19:19 2014
Installer started downloading the package: / CN12700-s2-
dk9.7.2.0.D1.1.CSCuo07721.bin
via bootflash
Install add bootflash: CN12700-s2-dk9.7.2.0.D1.1.CSCuo07721.bin
Copying file at Thu Jan 9 01:19:20 2014
Download success, 238545 bytes received
Verifying package
Checking MD5 at Thu Jan 9 01:19:21 2014
MD5 checksum OK
Checking HW platform at Thu Jan 9 01:19:22 2014
Checking SW platform at Thu Jan 9 01:19:23 2014
Package verified successfully
Sending patch file to plugin manager at Thu Jan 9 01:19:23 2014
The following package is now available to be activated: CN12700-s2-
dk9.7.2.0.D1.1.CSCuo07721.bin
Install operation 1 completed successfully at Thu Jan 9 01:19:24 2014

Install operation 2 by user 'admin' at Thu Jan 9 01:19:29 2014
Install activate CN12700-s2-dk9.7.2.0.D1.1.CSCuo07721.bin Install
activate action started
```

```

The software will be activated with process restart
2 processes affected
sysinfo (modified) vman
(modified)
Install operation 2 completed successfully at Thu Jan 9 01:19:45 2014

Install operation 3 by user 'admin' at Thu Jan 9 01:20:05 2014
Install commit CN12700-s2-dk9.7.2.0.D1.1.CSCuo07721.bin
MD5 checksum OK for patch: CN12700-s2-dk9.7.2.0.D1.1.CSCuo07721.bin
Install operation 3 completed successfully at Thu Jan 9 01:20:08 2014

Install operation 4 by user 'admin' at Thu Jan 9 01:20:21 2014
Install deactivate CN12700-s2-dk9.7.2.0.D1.1.bin
Install deactivate action started
The software will be deactivated with process restart
2 processes affected
sysinfo (modified) vman
(modified)
Install operation 4 completed successfully at Thu Jan 9 01:20:36 2014

Install operation 5 by user 'admin' at Thu Jan 9 01:20:43 2014
Install commit CN12700-s2-dk9.7.2.0.D1.1.CSCuo07721.bin
MD5 checksum OK for patch: CN12700-s2-dk9.7.2.0.D1.1.CSCuo07721.bin
Install operation 5 completed successfully at Thu Jan 9 01:20:46 2014

Install operation 6 by user 'admin' at Thu Jan 9 01:20:55 2014
Install remove CN12700-s2-dk9.7.2.0.D1.1.CSCuo07721.bin
Install operation 6 completed successfully at Thu Jan 9 01:20:57 2014

Install operation 7 by user 'admin' at Thu Jan 9 01:21:07 2014
Install remove
Install operation 7 completed successfully at Thu Jan 9 01:21:10 2014

```

This example shows the output after an SMU package has been activated but before the switch has been reloaded:

```

switch# show install log detail
Install operation 18 by user 'admin' at Sun Mar 9 00:42:10 2014
Install activate CN12700-s2-dk9.7.2.0.D1.1.CSCuo07721.bin
Install activate action started
The software will be activated with system reload
Install operation 18 !!WARNING!!
This patch will get activated only after a reload of the switch. at Sun Mar 9
00:42:12 2014

```

This example shows the details of the specific SMUs:

```

switch# show install package
Boot Images:
 Kickstart Image: bootflash:/ CN12700-s2-
 kickstart.7.2.0.D1.1.bin System Image: bootflash:/ CN12700-s2-
 dk9.7.2.0.D1.1.bin

CN12700-s2-dk9.7.2.0.D1.1.CSCuo07721.bin Active Committed

Modules

 Module #3: Active Committed

 Module #4: Active Committed

CN12700-s2-dk9.7.2.0.D1.1.CSCuo07721.bin Inactive

Modules

```

Module #3: Inactive  
Module #4: Inactive

## 22.5 Where to Go Next

For information about configuring control policies, see the "Configuring ISG Control Policies" module.

## 22.6 Additional References

### Related Documents

| Related Topic              | Document Title                                                         |
|----------------------------|------------------------------------------------------------------------|
| Software upgrades          | <i>Inspur CN12700 Series INOS Software Upgrade and Downgrade Guide</i> |
| System management commands | <i>System Management Command Reference</i>                             |

### 22.6.1 Related Documents

| Related Topic     | Document Title                                                         |
|-------------------|------------------------------------------------------------------------|
| Software upgrades | <i>Inspur CN12700 Series INOS Software Upgrade and Downgrade Guide</i> |

## 22.7 Feature Information for Performing Software Maintenance Upgrades

The following table provides release information about the SMU package files supported for this software. This table lists only the software release that introduced support for a given SMU package. Unless noted otherwise, subsequent releases of that software also support that SMU package.

Use Inspur Feature Navigator to find information about platform support and Inspur software image support. An account on Inspur.com is not required.

| SMU Package File                         | Releases | Description                                                                                                                                                                                                                                                                |
|------------------------------------------|----------|----------------------------------------------------------------------------------------------------------------------------------------------------------------------------------------------------------------------------------------------------------------------------|
| CN12700-s2-dk9.7.2.0.D1.1.CSCuo07721.bin | 7.2(0)   | Restart type: restart Platform: CN12700 Supersedes: None<br>Superseded By: None<br>Restart information: CSCuo07721 Pre-install activate scripts: None<br>Post-install activate scripts: None Pre-install deactivate scripts: None<br>Post-install deactivate scripts: None |

# CHAPTER 23 Converting CLI Commands to Network Configuration Format

This chapter explains how to install and use the XMLIN tool to convert CLI commands to the Network Configuration (NETCONF) protocol.

- Finding Feature Information
- Information About XMLIN
- Licensing Requirements for XMLIN
- Installing and Using the XMLIN Tool
- Converting Show Command Output to XML
- Configuration Examples for XMLIN
- Related Documents
- Feature History for XMLIN

## 23.1 Finding Feature Information

Your software release might not support all the features documented in this module. For the latest caveats and feature information, the release notes for your software release. To find information about the features documented in this module, and to see a list of the releases in which each feature is supported, see the “New and Changed Information” chapter or the Feature History table.

## 23.2 Information About XMLIN

The XMLIN tool converts CLI commands to the Network Configuration (NETCONF) protocol format. NETCONF is a network management protocol that provides mechanisms to install, manipulate, and delete the configuration of network devices. It uses XML-based encoding for configuration data and protocol messages. The INOS implementation of the NETCONF protocol supports the following protocol operations:

<get>, <edit-config>, <close-session>, <kill-session>, and <exec-command>.

The XMLIN tool converts show, EXEC, and configuration commands to corresponding NETCONF <get>, <exec-command>, and <edit-config> requests. You can enter multiple configuration commands into a single NETCONF <edit-config> instance.

The XMLIN tool also converts the output of show commands to XML format.

## 23.3 Licensing Requirements for XMLIN

Table 43 XMLIN Licensing Requirements

| Product     | License Requirement                                                                                                                                                                                                                                                            |
|-------------|--------------------------------------------------------------------------------------------------------------------------------------------------------------------------------------------------------------------------------------------------------------------------------|
| Inspur INOS | XMLIN requires no license. Any feature not included in a license package is bundled with the Inspur INOS system images and is provided at no extra charge to you. For a complete explanation of the Inspur INOS licensing scheme, see the <i>Inspur INOS Licensing Guide</i> . |

## 23.4 Installing and Using the XMLIN Tool

You can install the XMLIN tool and then use it to convert configuration commands to NETCONF format.

### Before you begin

Although the XMLIN tool is usually capable of generating NETCONF instances of commands even if the corresponding feature sets or the required hardware capabilities are not available on the device, you might have to install some feature sets before entering the `xmlin` command.

### Procedure

|               | Command or Action                                                      | Purpose                                                                                                                                                                                                                                       |
|---------------|------------------------------------------------------------------------|-----------------------------------------------------------------------------------------------------------------------------------------------------------------------------------------------------------------------------------------------|
| <b>Step 1</b> | <code>switch# xmlin</code>                                             |                                                                                                                                                                                                                                               |
| <b>Step 2</b> | <code>switch(xmlin)# configure terminal</code>                         | Enters global configuration mode.                                                                                                                                                                                                             |
| <b>Step 3</b> | Configuration commands                                                 | Converts configuration commands to NETCONF format.                                                                                                                                                                                            |
| <b>Step 4</b> | (Optional) <code>switch(config)(xmlin)# end</code>                     | Generates the corresponding <code>&lt;edit-config&gt;</code> request.<br><b>Note</b> You must enter the <code>end</code> command to finish the current XML configuration before you generate an XML instance for a <code>show</code> command. |
| <b>Step 5</b> | (Optional) <code>switch(config-if-verify)(xmlin)# show commands</code> | Converts <code>show</code> commands to NETCONF format.                                                                                                                                                                                        |
| <b>Step 6</b> | (Optional) <code>switch(config-if-verify)(xmlin)# exit</code>          | Returns to EXEC mode.                                                                                                                                                                                                                         |

## 23.5 Converting Show Command Output to XML

You can convert the output of show commands to XML.

### Before you begin

Make sure that all features for the commands you want to convert are installed and enabled on the device. Otherwise, the commands will fail.

You can use the terminal `verify-only` command to verify that a feature is enabled without entering it on the device.

Make sure that all required hardware for the commands you want to convert are present on the device. Otherwise, the commands will fail.

Make sure that the XMLIN tool is installed.

### Procedure

|               | Command or Action                         | Purpose                                                                                                   |
|---------------|-------------------------------------------|-----------------------------------------------------------------------------------------------------------|
| <b>Step 1</b> | <code>switch# show-command   xmlin</code> | Enters global configuration mode.<br><b>Note</b> You cannot use this command with configuration commands. |

## 23.6 Configuration Examples for XMLIN

The following example shows how the XMLIN tool is installed on the device and used to convert a set of configuration commands to an `<edit-config>` instance.

The following example shows how you must enter the `end` command to finish the current XML configuration before you generate an XML instance for a `show` command.

```
switch(xmlin)# configure terminal
```

```

Enter configuration commands, one per line. End with CNTL/Z.
switch(config)(xmlin)# interface ethernet 2/1
switch(config-if-verify)(xmlin)# show interface ethernet 2/1

Please type "end" to finish and output the current XML document before building a
new one.

% Command not successful
switch(config-if-verify)(xmlin)# end
<?xml version="1.0"?>
<nf:rpc xmlns:nf="urn:ietf:params:xml:ns:netconf:base:1.0"
xmlns="http://www.Inspur.com/nxos:6.2.2.:configure_"
xmlns:m="http://www.Inspur.com/nxos:6.2.2.:_exec" message-id="1">
 <nf:edit-config>
 <nf:target>
 <nf:running/>
 </nf:target>
 <nf:config>
 <m:configure>
 <m:terminal>
 <interface>
 < XML PARAM interface>
 < XML value>Ethernet2/1</ XML
 value>
 </ XML PARAM interface>
 </interface>
 </m:terminal>
 </m:configure>
 </nf:config>
</nf:edit-config>
</nf:rpc>
]]>]]>
switch(xmlin)# show interface ethernet 2/1
<?xml version="1.0"?>
<nf:rpc
xmlns:nf="urn:ietf:params:xml:ns:netconf:base:1.0"
xmlns="http://www.Inspur.com/nxos:6.2.2.:if_manager"
message-
id="1">
 <nf:get>
<nf:filter type="subtree">
 <show>
 <interface>
 < XML PARAM ifeth>
 < XML value>Ethernet2/1</ XML value>
 </ XML PARAM ifeth>
 </interface>
 </show>
</nf:filter>
</nf:get>
</nf:rpc>
]]>]]>
switch(xmlin)# exit
switch#

```

The following example shows how you can convert the output of the show interface brief command to XML.

```

switch# show interface brief | xmlin
<?xml version="1.0"?>
<nf:rpc xmlns:nf="urn:ietf:params:xml:ns:netconf:base:1.0"
xmlns="http://www.Inspur.com/nxos:6.2.2.:if_manager"
message-id="1">
 <nf:get>
 <nf:filter type="subtree">

```



```

 <show>
 <interface>
 <brief/>
 </interface>
 </show>
 </nf:filter>
 </nf:get>
</nf:rpc>
]]>]]>

```

## 23.7 Related Documents

| Related Topic                                                                                                     | Document Title                                                        |
|-------------------------------------------------------------------------------------------------------------------|-----------------------------------------------------------------------|
| XMLIN commands: complete command syntax, command modes, command history, defaults, usage guidelines, and examples | <i>Inspur CN12700 Series INOS System Management Command Reference</i> |

## 23.8 Feature History for XMLIN

The table below summarizes the new and changed features for this document and shows the releases in which each feature is supported. Your software release might not support all the features in this document. For the latest caveats and feature information, the release notes for your software release.

Table 44 Feature History for XMLIN

| Feature Name | Releases | Feature Information          |
|--------------|----------|------------------------------|
| XMLIN        | 6.2(2)   | This feature was introduced. |

## CHAPTER 24 IETF RFCs supported by Inspur INOS System Management

This appendix lists the IETF RFCs for system management supported in Inspur INOS.

- IETF RFCs Supported by Inspur INOS System Management

### 24.1 IETF RFCs Supported by Inspur INOS System Management

This appendix lists the IETF RFCs for system management supported in Inspur INOS.

| RFCs                  | Title                                                                                                 |
|-----------------------|-------------------------------------------------------------------------------------------------------|
| RFC 2819              | <i>Remote Network Monitoring Management Information Base</i>                                          |
| RFC 3164              | <i>The BSD syslog Protocol</i>                                                                        |
| RFC 3411 and RFC 3418 | <i>An Architecture for Describing Simple Network Management Protocol (SNMP) Management Frameworks</i> |
| RFC 3954              | <i>Inspur Systems NetFlow Services Export Version 9</i>                                               |

Embedded Event Manager System Events and Configuration Examples

This appendix describes the Embedded Event Manager (EEM) system policies, events, and policy configuration examples.

This appendix includes the following sections:

- EEM System Policies
- EEM Events
- Configuration Examples for EEM Policies

### 24.2 EEM System Policies

The following table lists the Embedded Event Manager (EEM) system policies.

| Event                   | Description                                                                                                                                                      |
|-------------------------|------------------------------------------------------------------------------------------------------------------------------------------------------------------|
| __PortLoopback          | Do CallHome, log error in Syslog/OBFL/Exception Log, and disable further HM testing on affected ports after 10 consecutive failures of GOLD "PortLoopback" test  |
| __RewriteEngineLoopback | Do CallHome, log error in Syslog/OBFL/Exception Log, and disable further HM testing on affected ports after 10 consecutive failures of GOLD "RewriteEngine" test |
| __asic_register_check   | Do CallHome, log error, and disable further HM testing for that ASIC device/instance after 20 consecutive failures of GOLD "ASICRegisterCheck" test              |
| __compact_flash         | Do CallHome, log error, and disable further HM testing after 20 consecutive failures of GOLD "CompactFlash" test                                                 |
| __crypto_device         | Do CallHome and log error when GOLD "CryptoDevice" test fails                                                                                                    |
| __eobc_port_loopback    | Do CallHome and log error when GOLD "EOBCPortLoopback" test fails                                                                                                |
| __ethpm_debug_1         | Action: none                                                                                                                                                     |
| __ethpm_debug_2         | Action: none                                                                                                                                                     |
| __ethpm_debug_3         | Action: none                                                                                                                                                     |

| Event                         | Description                                                                                                                                       |
|-------------------------------|---------------------------------------------------------------------------------------------------------------------------------------------------|
| __ethpm_debug_4               | Action: none                                                                                                                                      |
| __ethpm_link_flap             | More than 30 link flaps in a 420-second interval. Action: Error. Disable the port                                                                 |
| __external_compact_flash      | Do CallHome, log error, and disable further HM testing after 20 consecutive failures of GOLD "ExternalCompactFlash" test                          |
| __lcm_module_failure          | Power cycle two times and then power down                                                                                                         |
| __management_port_loopback    | Do CallHome and log error when GOLD "ManagementPortLoopback" test fails                                                                           |
| __nvram                       | Do CallHome, log error, and disable further HM testing after 20 consecutive failures of GOLD "NVRAM" test                                         |
| __pfm_fanabsent_all_systemfan | Shuts down if both fan trays (f1 and f2) are absent for 2 minutes                                                                                 |
| __pfm_fanbad_all_systemfan    | Syslog when fan goes bad                                                                                                                          |
| __pfm_fanbad_any_singlefan    | Syslog when fan goes bad                                                                                                                          |
| __pfm_power_over_budget       | Syslog warning for insufficient power overbudget                                                                                                  |
| __pfm_tempev_major            | TempSensor Major Threshold. Action: Shutdown                                                                                                      |
| __pfm_tempev_minor            | TempSensor Minor Threshold. Action: Syslog                                                                                                        |
| __primary_bootrom             | Do CallHome, log error, and disable further HM testing after 20 consecutive failures of GOLD "PrimaryBootROM" test                                |
| __pwr_mgmt_bus                | Do CallHome, log error, and disable further HM testing for the module or spine-card after 20 consecutive failures of GOLD "PwrMgmtBus" test       |
| __real_time_clock             | Do CallHome, log error, and disable further HM testing after 20 consecutive failures of GOLD "RealTimeClock" test                                 |
| __secondary_bootrom           | Do CallHome, log error, and disable further HM testing after 20 consecutive failures of GOLD "SecondaryBootROM" test                              |
| __spine_control_bus           | Do CallHome, log error, and disable further HM testing for that module or spine-card after 20 consecutive failures of GOLD "SpineControlBus" test |
| __standby_fabric_loopback     | Do CallHome, log error, and disable further HM testing after 10 consecutive failures                                                              |
| __status_bus                  | Do CallHome, log error, and disable further HM testing after 5 consecutive failures of GOLD "StatusBus" test                                      |
| __system_mgmt_bus             | Do Call Home, log error, and disable further HM testing for that fan or power supply after 20 consecutive failures of GOLD "SystemMgmtBus" test   |
| __usb                         | Do Call Home and log error when GOLD "USB" test fails                                                                                             |

## 24.3 EEM Events

The following table describes the EEM events you can use on the device.

| EEM Event   | Description                                                    |
|-------------|----------------------------------------------------------------|
| application | Publishes an application-specific event.                       |
| cli         | CLI command is entered that matches a pattern with a wildcard. |
| counter     | EEM counter reaches a specified value or range.                |
| fanabsent   | System fan tray is absent.                                     |
| fanbad      | System fan generates a fault.                                  |
| fib         | Monitors routes or TCAM usage in the unicast FIB.              |
| gold        | GOLD test failure condition is hit.                            |
| interface   | Interface counter exceeds a threshold.                         |
| memory      | Available system memory exceeds a threshold.                   |

| EEM Event       | Description                                                                                  |
|-----------------|----------------------------------------------------------------------------------------------|
| module          | Specified module enters the selected status.                                                 |
| module-failure  | Module failure is generated.                                                                 |
| none            | Runs the policy event without any events specified.                                          |
| oir             | Online insertion or removal occurs.                                                          |
| policy-default  | Default parameters and thresholds are used for the events in the system policy you override. |
| poweroverbudget | Platform software detects a power budget condition.                                          |
| snmp            | SNMP object ID (OID) state changes.                                                          |
| storm-control   | Platform software detects an Ethernet packet storm condition.                                |
| syslog          | Monitors syslog messages and invokes the policy based on the search string in the policy.    |
| sysmgr          | System manager generates an event.                                                           |
| temperature     | Temperature level in the system exceeds a threshold.                                         |
| timer           | Specified time is reached.                                                                   |
| track           | Tracked object changes state.                                                                |

## 24.4 Configuration Examples for EEM Policies

### 24.4.1 Configuration Examples for CLI Events

#### 24.4.1.1 Monitoring Interface Shutdown

This example shows how to monitor an interface shutdown:

```
switch# configure terminal
Enter configuration commands, one per line. End with CNTL/Z.
switch(config)# event manager applet monitorShutdown
switch(config-applet)#
switch(config-applet)# description "Monitors interface shutdown."
switch(config-applet)# event cli match "conf t; interface *; shutdown"
switch(config-applet)# action 1.0 cli show interface e 3/1
switch(config)# copy running-config startup-config
```

#### 24.4.1.2 Monitoring Module Powerdown

This example shows how to monitor a module powerdown:

```
switch# configure terminal
Enter configuration commands, one per line. End with CNTL/Z.
switch(config)# event manager applet monitorPoweroff
switch(config-applet)#
switch(config-applet)# description "Monitors module power down."
switch(config-applet)# event cli match "conf t ; poweroff *"
switch(config-applet)# action 1.0 cli show module
switch(config)# copy running-config startup-config
```

#### 24.4.1.3 Adding a Trigger to Initiate a Rollback

This example shows how to add a trigger to initiate a rollback:

```
switch# configure terminal
Enter configuration commands, one per line. End with CNTL/Z.
switch(config)#
switch(config)# event manager applet rollbackTrigger
```

```
switch(config-applet)#
switch(config-applet)# description "Rollback trigger."
switch(config-applet)# event cli match "rollback *"
switch(config-applet)# action 1.0 cli copy running-config bootflash:last_config
switch(config)# copy running-config startup-config
```

## 24.4.2 Configuration Examples to Override (Disable) Major Thresholds

### 24.4.2.1 Preventing a Shutdown When Reaching a Major Threshold

This example shows how to prevent a shutdown caused by reaching a major threshold:

```
switch# configure terminal
switch(config)# event manager applet myappletname override pfm_tempev_major
switch(config)# end
```

This example shows how to revert to the default configuration:

```
switch# configure terminal
switch(config)# no event manager applet myappletname override pfm_tempev_major
switch(config)# end
```

### 24.4.2.2 Disabling One Bad Sensor

This example shows how to disable only sensor 3 on module 2 when sensor 3 is malfunctioning (all other sensors are unaffected):

```
switch# configure terminal
switch(config)# event manager applet myappletname override pfm_tempev_major
switch(config-applet)# event temperature module 2 sensor 3 threshold major
switch(config-applet)# end
```

This example shows how to revert to the default configuration:

```
switch# configure terminal
switch(config)# no event manager applet myappletname override pfm_tempev_major
switch(config)# end
```

### 24.4.2.3 Disabling Multiple Bad Sensors

This example shows how to disable sensors 5, 6, and 7 on module 2 when these sensors are malfunctioning (all other sensors are unaffected):

```
switch# configure terminal
switch(config)# event manager applet myappletname override pfm_tempev_major
switch(config-applet)# event temperature module 2 sensor 5 threshold major
switch(config-applet)# end
switch# configure terminal
switch(config)# event manager applet myappletname override pfm_tempev_major
switch(config-applet)# event temperature module 2 sensor 6 threshold major
switch(config-applet)# end
switch# configure terminal
switch(config)# event manager applet myappletname override pfm_tempev_major
switch(config-applet)# event temperature module 2 sensor 7 threshold major
switch(config-applet)# end
```

This example shows how to revert to the default configuration:

```
switch# configure terminal
switch(config)# no event manager applet myappletname override pfm_tempev_major
switch(config)# end
```

#### 24.4.2.4 Overriding (Disabling) an Entire Module

This example shows how to disable module 2 when it is malfunctioning:

```
switch# configure terminal
switch(config)# event manager applet myappletname override pfm_tempev_major
switch(config-applet)# event temperature module 2 threshold major
switch(config-applet)# end
```

This example shows how to revert to the default configuration:

```
switch# configure terminal
switch(config)# no event manager applet myappletname override pfm_tempev_major
switch(config)# end
```

#### 24.4.2.5 Overriding (Disabling) Multiple Modules and Sensors

This example shows how to disable sensors 3, 4, and 7 on module 2 and all sensors on module 3 when they are malfunctioning:

```
switch# configure terminal
switch(config)# event manager applet myappletname override pfm_tempev_major
switch(config-applet)# event temperature module 2 sensor 3 threshold major
switch(config-applet)# end
switch# configure terminal
switch(config)# event manager applet myappletname override pfm_tempev_major
switch(config-applet)# event temperature module 2 sensor 4 threshold major
switch(config-applet)# end
switch# configure terminal
switch(config)# event manager applet myappletname override pfm_tempev_major
switch(config-applet)# event temperature module 2 sensor 7 threshold major
switch(config-applet)# end
switch# configure terminal
switch(config)# event manager applet myappletname override pfm_tempev_major
switch(config-applet)# event temperature module 3 threshold major
switch(config-applet)# end
```

This example shows how to revert to the default configuration:

```
switch# configure terminal
switch(config)# no event manager applet myappletname override pfm_tempev_major
switch(config)# end
```

#### 24.4.2.6 Enabling One Sensor While Disabling All Remaining Sensors of All Modules

This example shows how to disable all sensors on all modules except sensor 4 on module 9:

```
switch# configure terminal
switch(config)# event manager applet myapplet1 override pfm_tempev_major
switch(config-applet)# end
switch# configure terminal
switch(config)# event manager applet myapplet2 override pfm_tempev_major
switch(config-applet)# event temperature module 9 sensor 4 threshold major
switch(config-applet)# action 2 policy-default
switch(config-applet)# end
```

### 24.4.2.7 Enabling Multiple Sensors While Disabling All Remaining Sensors of All Modules

This example shows how to disable all sensors on all modules except sensors 4, 6, and 7 on module 9:

```
switch# configure terminal
switch(config)# event manager applet myapplet1 override pfm_tempev_major
switch(config-applet)# end
switch# configure terminal
switch(config)# event manager applet myapplet2 override pfm_tempev_major
switch(config-applet)# event temperature module 9 sensor 4 threshold major
switch(config-applet)# action 2 policy-default
switch(config-applet)# end
switch# configure terminal
switch(config)# event manager applet myapplet3 override pfm_tempev_major
switch(config-applet)# event temperature module 9 sensor 6 threshold major
switch(config-applet)# action 3 policy-default
switch(config-applet)# end
switch# configure terminal
switch(config)# event manager applet myapplet4 override pfm_tempev_major
switch(config-applet)# event temperature module 9 sensor 7 threshold major
switch(config-applet)# action 4 policy-default
switch(config-applet)# end
```

### 24.4.2.8 Enabling All Sensors of One Module While Disabling All Sensors of the Remaining Modules

This example shows how to disable all sensors on all modules except all sensors on module 9:

```
switch# configure terminal
switch(config)# event manager applet myapplet1 override pfm_tempev_major
switch(config-applet)# end
switch# configure terminal
switch(config)# event manager applet myapplet2 override pfm_tempev_major
switch(config-applet)# event temperature module 9 threshold major
switch(config-applet)# action 2 policy-default
switch(config-applet)# end
```

### 24.4.2.9 Enabling a Combination of Sensors on Modules While Disabling All Sensors of the Remaining Modules

This example shows how to disable all sensors on all modules except sensors 3, 4, and 7 on module 2 and all sensors on module 3:

```
switch# configure terminal
switch(config)# event manager applet myapplet1 override pfm_tempev_major
switch(config-applet)# end
switch# configure terminal
switch(config)# event manager applet myapplet2 override pfm_tempev_major
switch(config-applet)# event temperature module 2 sensor 3 threshold major
switch(config-applet)# action 2 policy-default
switch(config-applet)# end
switch# configure terminal
switch(config)# event manager applet myapplet3 override pfm_tempev_major
switch(config-applet)# event temperature module 2 sensor 4 threshold major
switch(config-applet)# action 3 policy-default
switch(config-applet)# end
switch# configure terminal
switch(config)# event manager applet myapplet4 override pfm_tempev_major
```

```

switch(config-applet)# event temperature module 2 sensor 7 threshold major
switch(config-applet)# action 4 policy-default
switch(config-applet)# end
switch# configure terminal
switch(config)# event manager applet myapplet5 override pfm_tempev_major
switch(config-applet)# event temperature module 3 threshold major
switch(config-applet)# action 5 policy-default
switch(config-applet)# end

```

## 24.4.3 Configuration Examples to Override (Disable) Shutdown for Fan Tray Removal

### 24.4.3.1 Overriding (Disabling) a Shutdown for Removal of One or More Fan Trays

This example shows how to disable a shutdown so that you can remove one or more (or all) fan trays:

```

switch# configure terminal
switch(config)# event manager applet myappletname override pfm_fanabsent_any_singlefan
switch(config-applet)# end

```

This example shows how to revert to the default configuration:

```

switch# configure terminal
switch(config)# no event manager applet myappletname override pfm_fanabsent_any_singlefan
switch(config-applet)# end

```

### 24.4.3.2 Overriding (Disabling) a Shutdown for Removal of a Specified Fan Tray

This example shows how to disable a shutdown so that you can remove a specified fan tray (fan tray 3):

```

switch# configure terminal
switch(config)# event manager applet myappletname override pfm_fanabsent_any_singlefan
switch(config-applet)# event fanabsent fan 3 time 60
switch(config-applet)# end

```

This example shows how to revert to the default configuration:

```

switch# configure terminal
switch(config)# no event manager applet myappletname override pfm_fanabsent_any_singlefan
switch(config)# end

```

### 24.4.3.3 Overriding (Disabling) a Shutdown for Removal of Multiple Specified Fan Trays

This example shows how to disable a shutdown so that you can remove multiple specified fan trays (fan trays 2, 3, and 4):

```

switch# configure terminal
switch(config)# event manager applet myapplet1 override pfm_fanabsent_any_singlefan
switch(config-applet)# event fanabsent fan 2 time 60
switch(config-applet)# end
switch# configure terminal
switch(config)# event manager applet myapplet2 override pfm_fanabsent_any_singlefan
switch(config-applet)# event fanabsent fan 3 time 60
switch(config-applet)# end
switch# configure terminal
switch(config)# event manager applet myapplet3 override pfm_fanabsent_any_singlefan
switch(config-applet)# event fanabsent fan 4 time 60
switch(config-applet)# end

```



This example shows how to revert to the default configuration:

```
switch# configure terminal
switch(config)# no event manager applet myappletname override pfm_fanabsent_any_singlefan
switch(config)# end
```

#### 24.4.3.4 Overriding (Disabling) a Shutdown for Removal of All Fan Trays Except One

This example shows how to disable a shutdown so that you can remove all fan trays except one (fan tray 2):

```
switch# configure terminal
switch(config)# event manager applet myapplet1 override pfm_fanabsent_any_singlefan
switch(config-applet)# end
switch# configure terminal
switch(config)# event manager applet myapplet2 override pfm_fanabsent_any_singlefan
switch(config-applet)# event fanabsent fan 2 time 60
switch(config-applet)# action 2 policy-default
switch(config-applet)# end
```

#### 24.4.3.5 Overriding (Disabling) a Shutdown for Removal of Fan Trays Except for a Specified Set of Fan Trays

This example shows how to disable a shutdown so that you can remove fans except for a specified set of fan trays (fan trays 2, 3, and 4):

```
switch# configure terminal
switch(config)# event manager applet myapplet1 override pfm_fanabsent_any_singlefan
switch(config-applet)# end
switch(config)# event manager applet myapplet2 override pfm_fanabsent_any_singlefan
switch(config-applet)# event fanabsent fan 2,3,4 time 60
switch(config-applet)# action 2 policy-default
switch(config-applet)# end
```

#### 24.4.3.6 Overriding (Disabling) a Shutdown for Removal of All Fan Trays Except One from a Set of Fan Trays

This example shows how to disable a shutdown so that you can remove all fan trays except one from a set of fan trays (fan trays 2, 3, or 4):

```
switch# configure terminal
switch(config)# event manager applet myapplet1 override pfm_fanabsent_any_singlefan
switch(config-applet)# end
switch# configure terminal
switch(config)# event manager applet myapplet2 override pfm_fanabsent_any_singlefan
switch(config-applet)# event fanabsent fan 2 time 60
switch(config-applet)# action 2 policy-default
switch(config-applet)# end
switch# configure terminal
switch(config)# event manager applet myapplet3 override pfm_fanabsent_any_singlefan
switch(config-applet)# event fanabsent fan 3 time 60
switch(config-applet)# action 3 policy-default
switch(config-applet)# end
switch# configure terminal
switch(config)# event manager applet myapplet4 override pfm_fanabsent_any_singlefan
switch(config-applet)# event fanabsent fan 4 time 60
switch(config-applet)# action 4 policy-default
switch(config-applet)# end
```

## 24.4.4 Configuration Examples to Create a Supplemental Policy

### 24.4.4.1 Creating a Supplemental Policy for the Fan Tray Absent Event

This example shows how to create a supplemental policy using the event fanabsent command: [no] event fanabsent [fan fan-tray-number] time time-interval

In addition to the default policy, this example shows how to execute the policy myappletname and action 3 if fan tray 1 is absent for 60 seconds:

```
switch# configure terminal
switch(config)# event manager applet myappletname
switch(config-applet)# event fanabsent fan 1 time 60
switch(config-applet)# action 3 cli "show env fan"
switch(config-applet)# end
```

### 24.4.4.2 Creating a Supplemental Policy for the Temperature Threshold Event

This example shows how to create a supplemental policy using the event temperature command:

[no] event temperature [mod module-number] [sensor sensor-number] threshold {major | minor | any}

In addition to the default policy, this example shows how to execute the policy myappletname and action 1 if the temperature crosses the minor threshold on sensor 3 of module 2:

```
switch# configure terminal
switch(config)# event manager applet myappletname
switch(config-applet)# event temperature module 2 sensor 3 threshold minor
switch(config-applet)# action 1 cli "show environ temperature"
switch(config-applet)# end
```

## 24.4.5 Configuration Examples for the Power Over-Budget Policy

The power over-budget policy gets triggered when the available power capacity drops below zero and the device is no longer able to keep the previously powered-up modules in the powered-up state. The default action is to print a syslog to notify the user of the occurrence of power over budget.

You can enable an additional action to power down modules until the available power recovers from the red (negative) zone.

### 24.4.5.1 Shutting Down Modules

If you do not specify any modules, the power over-budget shutdown starts from slot 1 and shuts down modules until the power recovers from the red (negative) zone. Empty slots and slots that contain a supervisor, standby supervisor, spine, or crossbar are skipped.

This example shows how to shut down modules starting from module 1 when the available power drops below zero:

```
switch# configure terminal
switch(config)# event manager applet <myappletname4a> override pfm_power_over_budget
switch(config-applet)# event poweroverbudget
switch(config-applet)# action 4 overbudgetshut
switch(config-applet)# end
```

### 24.4.5.2 Shutting Down a Specified List of Modules

You can specify a list of modules that the power over-budget action uses to shut down modules until the power recovers from the red (negative) zone. Empty slots and slots that contain a supervisor, standby supervisor, spine, or crossbar are skipped.

This example shows how to shut down modules from a specified list of modules (1, 2, 7, 8) when the available power drops below zero:

```
switch# configure terminal
switch(config)# event manager applet <myappletname4b> override pfm_power_over_budget
switch(config-applet)# event poweroverbudget
switch(config-applet)# action 5 overbudgetshut module 1,2,7,8
switch(config-applet)# end
```

## 24.4.6 Configuration Examples to Select Modules to Shut Down

### 24.4.6.1 Using the Policy Default to Select Nonoverridden Modules to Shut Down

This example shows how to use the policy default to select the nonoverridden modules to shut down when a major threshold is exceeded:

```
switch# configure terminal
switch(config)# event manager applet my5a1 override pfm_tempev_major
switch(config-applet)# end
switch# configure terminal
switch(config)# event manager applet my5a2 override pfm_tempev_major
switch(config-applet)# event temperature module 1-3 sensor 4 threshold major
switch(config-applet)# action 5 policy-default
switch(config-applet)# end
```

### 24.4.6.2 Using Parameter Substitution to Select Nonoverridden Modules to Shut Down

This example shows how to use parameter substitution to select the nonoverridden modules to shut down when a major threshold is exceeded:

```
switch# configure terminal
switch(config)# event manager applet my5b1 override pfm_tempev_major
switch(config-applet)# end
switch# configure terminal
switch(config)# event manager applet my5b2 override pfm_tempev_major
switch(config-applet)# event temperature module 1-3 sensor 8 threshold major
switch(config-applet)# action 6 forceshut module my_module_list reset "temperature-sensor
policy trigger"
switch(config-applet)# end
```

To create event manager parameters, use the event manager environment command. To display the values of event manager parameters, use the show event manager environment all command.

## 24.4.7 Configuration Examples for the Online Insertion Removal Event

The online insertion removal (OIR) event does not have a default policy.

This example shows how to configure the OIR event using the event oir command:

```
event oir device-type event-type [device-number]
```

The device-type can be fan, module, or powersupply.

The event-type can be insert, remove, or anyoir (insert or remove).

The optional device-number specifies a single device. If omitted, all devices are selected. This example shows how to configure the insert event:

```
switch# configure terminal
switch(config)# event manager applet myoir
switch(config-applet)# event oir module insert
switch(config-applet)# action 1 syslog priority critical msg "OIR insert event: A Module is inserted"
```

This example shows how to configure the remove event:

```
switch# configure terminal
switch(config)# event manager applet myoir
switch(config-applet)# event oir module remove
switch(config-applet)# action 1 syslog priority critical msg "OIR remove event: A Module is removed"
```

## 24.4.8 Configuration Example to Generate a User Syslog

This example shows how to generate a user syslog using the action syslog command:

```
switch# configure terminal
switch(config)# event manager applet myoir
switch(config-applet)# event oir module remove
switch(config-applet)# action 1 syslog priority critical msg "Module is removed"
```

When this event is triggered, the system generates a syslog as follows:

```
switch(config)# 2013 May 20 00:08:27 plb-57 %$ VDC-1 %$ %EEM_ACTION-2-CRIT: "Module is removed"
```

## 24.4.9 Configuration Example to Monitor Syslog Messages

This example shows how to monitor syslog messages from the switch:

```
switch(config)# event manager applet a1
switch(config-applet)# event syslog occurs 6 period 4294967 pattern "authentication failed"
```

When this event is triggered, the action defined in the policy is executed.

## 24.4.10 Configuration Examples for SNMP Notification

### 24.4.10.1 Polling an SNMP OID to Generate an EEM Event

The SNMP object ID (OID) INSPUR-SYSTEM-EXT-MIB::cseSysCPUUtilization is used for querying the CPU utilization of the switch:

```
cseSysCPUUtilization OBJECT-TYPE
SYNTAX Gauge32 (0..100)
UNITS "%"
MAX-ACCESS read-only
STATUS current
DESCRIPTION
"The average utilization of CPU on the active supervisor."
::= { InspurSysInfoGroup 1 }
```

This example shows the use of an SNMP OID that is polled at an interval of 10 seconds and has a threshold value of 95 percent:

```
switch# configure terminal
switch(config)# event manager applet test_policy
switch(config-applet)# event snmp oid 1.3.6.1.4.1.9.9.305.1.1.1.0 get-type exact
```

---

```
entry-op gt entry-val 95 exit-op lt exit-val 90 poll-interval 10
```

### 24.4.10.2 Sending an SNMP Notification in Response to an Event in the Event Policy

You can use this type of configuration to cause a critical event trigger to generate an SNMP notification.

This example shows how to send an SNMP notification for an event from the Event Manager applet configuration mode:

```
switch(config-applet)# action 1.1 snmp-trap intdata1 100 intdata2 300 strdata "CPU
Hogging at switch1"
switch(config-applet)# action 1.1 snmp-trap intdata1 100 intdata2 300 strdata "Port
Failure eth9/1"
```

This configuration triggers an SNMP notification (trap) from the switch to SNMP hosts. The SNMP payload carries the values of user-defined fields intdata1, intdata2, and strdata.

### 24.4.11 Configuration Example for Port Tracking

This example shows how to configure the state of one port to match the state of another port (port tracking). To configure the port tracking of Ethernet interface 3/23 by Ethernet interface 1/2, follow these steps:

#### Procedure

- 
- Step 1** Create an object to track the status of Ethernet interface 3/23.

#### Example:

```
switch# configure terminal
switch(config)# track 1 interface ethernet 3/23
switch(config-track)# end
```

- Step 2** Configure an EEM event to shut Ethernet interface 1/2 when the tracking object shuts down.

#### Example:

```
switch(config)# event manager applet track_3_23_down
switch(config-applet)# event track 1 state down
switch(config-applet)# action 1 syslog msg EEM applet track_3_23_down shutting down
port eth1/2 due to eth3/23 being down
switch(config-applet)# action 2 cli conf term
switch(config-applet)# action 3 cli interface ethernet 1/2
switch(config-applet)# action 4 cli shut
switch(config-applet)# end
```

- Step 3** Configure an EEM event to bring up Ethernet interface 1/2 when Ethernet interface 3/23 comes up.

#### Example:

```
switch# configure terminal
switch(config)# event manager applet track_3_23_up
switch(config-applet)# event track 1 state up
switch(config-applet)# action 1 syslog msg EEM applet track_3_23_down bringing up
port eth1/2 due to eth3/23 being up
switch(config-applet)# action 2 cli conf term
switch(config-applet)# action 3 cli interface ethernet 1/2
switch(config-applet)# action 4 cli no shut
switch(config-applet)# end
```

---

## 24.4.12 Configuration Example to Register an EEM Policy with the EEM

This example shows how to register an EEM policy with the EEM: Basic switch configuration:

```

event manager applet vpc_check_peer_at_startup
event track 101 state up
action 1.0 cli copy bootflash:eem/user_script_policies/load_schedules running-

config

feature scheduler

!!## 2 x dummy loopbacks are required ###
interface loopback 101
interface loopback 102

track 1 list boolean or

object 13
object 12
object 102
track 2 list boolean and
object 13
object 12
track 12 interface Ethernet 2/24 line-protocol track
13 interface port-channel 3000 line-protocol
track 101 interface loopback 101 line-protocol
track 102 interface loopback 102 line-protocol

```

You need to copy the following files to the bootflash:

- A directory called: /eem/user\_script\_policies needs to be created on the supervisor bootflash.
- These five files need to be created and loaded into the above directory:
- load\_schedules
- remove\_vpc\_if\_peer\_failed
- clean\_up
- unload\_schedules
- restore\_vpc

Configuration for the load\_schedules file:

```

feature scheduler
configure terminal scheduler
job name vpc_check configure
terminal
event manager policy remove_vpc_if_peer_failed
end
configure terminal scheduler
job name clean_up configure
terminal
event manager policy clean_up
end
configure terminal scheduler
job name trigger configure
terminal interface loopback
102 shutdown
no shutdown
end
configure terminal
scheduler schedule name load_vpc_check
time start +00:00:04

```

```

job name vpc_check
scheduler schedule name trigger_vpc_check
time start +00:00:05
job name trigger
scheduler schedule name load_clean_up
time start +00:00:08

job name clean_up
scheduler schedule name trigger_clean_up
time start +00:00:10
job name trigger

```

#### Configuration for the remove\_vpc\_if\_peer\_failed file:

```

event manager applet remove_vpc_if_peer_failed
event track 1 state down
action 1.0 cli show run vpc > bootflash://sup-
active/eem/user_script_policies/vpc_saved.cfg action 2.0 cli show run vpc >
bootflash://sup-standby/eem/user_script_policies/vpc_saved.cfg action 3.0 cli
configure
terminal
action 4.0 cli no feature vpc
action 5.0 syslog msg severity alert "##### WARNING!!!! PEER SWITCH FAILED TO COME
ONLINE.
VPC CONFIG REMOVED #####"
action 6.0 cli event manager policy restore_vpc
action 7.0 cli copy bootflash:eem/user_script_policies/unload_schedules running-
config
action 8.0 cli no event manager applet remove_vpc_if_peer_failed
action 9.0 cli end

```

#### Configuration for the clean\_up file:

```

event manager applet clean_up
event track 102 state up
action 1.0 cli configure terminal
action 2.0 cli no event manager applet remove_vpc_if_peer_failed
action 3.0 cli copy bootflash:eem/user_script_policies/unload_schedules running
action 4.0 cli no event manager applet clean_up
action 5.0 end

```

#### Configuration for the unload\_schedules file:

```

no scheduler schedule name load_vpc_check
no scheduler schedule name trigger_vpc_check
no scheduler schedule name load_clean_up
no scheduler schedule name trigger_clean_up
no scheduler job name vpc_check
no scheduler job name trigger
no scheduler job name clean_up

```

#### Configuration for the restore\_vpc file:

```

event manager applet restore_vpc
event track 2 state up
action 1.0 cli copy bootflash:eem/user_script_policies/vpc_saved.cfg running-config
action 2.0 syslog msg severity alert "##### VPC PEER DETECTED. VPC CONFIG RESTORED
#####"
action 3.0 cli configure terminal
action 4.0 cli copy bootflash:eem/user_script_policies/unload_schedules running-
config
action 5.0 cli no event manager applet restore_vpc
action 6.0 cli end

```